





AKUMULATORJI IN POLNILNIKI

3



PRIBOR ZA AKUMULATORSKO ORODJE

13



AKUMULATORSKE SVETILKE IN PRIBOR

36



PRIBOR ZA LASERSKE MERILNIKE

41



PRIBOR ZA RUŠENJE IN VRTANJE

44



PRIBOR ZA VRTANJE

71



KRONSKÉ ŽAGE

90



PRIBOR ZA VIJAČENJE

108



PRIBOR ZA REZANJE IN BRUŠENJE

130



PRIBOR ZA POLIRANJE IN BRUŠENJE

179



PRIBOR ZA REZKANJE IN OBLANJE

192



PRIBOR ZA MULTIFUNKCIJSKO ORODJE

207



PRIBOR ZA ŽAGANJE

217



PRIBOR ZA ŽEBLJALNIKE IN SPENJALNIKE

253



PRIBOR ZA FENE

260



PRIBOR ZA SESANJE

262



PRIBOR ORODJA ZA UPORABO NA PROSTEM

288



PRIBOR ZA NOŠENJE ORODJA IN ZAŠČITNA OPREMA

329



KOVČKI IN TORBE ZA ORODJE

332



ROČNO ORODJE

346



RAZNO

357



PRIBOR ZA MEŠANJE

363



# AKUMULATORJI IN POLNILNIKI



**DIGITALNA KOMUNIKACIJA**  
orodje ◀▶ akumulator ◀▶ polnilnik

XGT je nov sistem orodij, akumulatorjev in polnilnikov. Kombinacija inovativne zasnove orodij in močnejših akumulatorjev ponuja edinstveno rešitev za zahtevno uporabo.

## OPTIMALNI SISTEM DOVAJANJA ENERGIJE IN OPTIMALNI SISTEM POLNJENJA

XGT serija ima vgrajen sistem za digitalno izmenjavo podatkov med akumulatorjem, orodjem in polnilnikom za optimalno delovanje. Serija vključuje tudi optimalni sistem polnjenja, ki s pomočjo izmenjave podatkov in polnilnika z dvema ventilatorjema za hlajenje skrbi za hitro in optimalno polnjenje.

Akumulatorska tehnologija in zasnova motorja delujeta skladno za optimalne rezultate.



## VZDRŽLJIV

Izjemno vzdržljiva zasnova 40 V max Li-ion akumulatorjev.

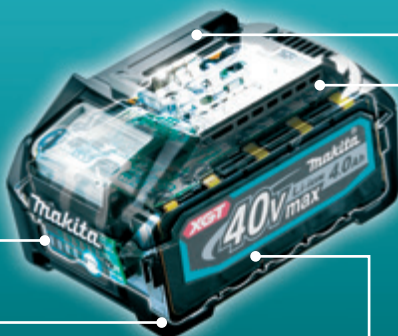

Struktura za preprečevanje kratkega stika vsebuje zaščitno steno med terminali za zaščito pred vodo in prahom.



Struktura za blaženje udarcev s praznim prostorom med ohišjem in držalom za celice, ki ublaži šok od udarcev.



1: izolacijska plast  
2: film 3: vodoodporni obroči

Tro-slojna vodoodporna struktura preprečuje odpoved celic zaradi vode ali prahu.



Vzdržljiv drsni priključak akumulatorja zagotavlja zanesljivo povezavo med akumulatorjem in orodjem.



## OPTIMALNI SISTEM POLNJENJA

Akumulator je pred pričetkom polnjenja potrebno ohladiti. Za to poskrbi integriran ventilator v polnilniku, ki s kroženjem zraka ohladi akumulator in omogoči hitrejše polnjenje. Polnilnik med polnjenjem neprestano digitalno komunicira z akumulatorjem in aktivno nadzira tok, napetost in temperaturo, ter s tem zagotavlja optimalno polnjenje in ohranja življenjsko dobo akumulatorja.

### Optimalni sistem polnjenja

Prisilno zračno hlajenje



### Splošna metoda polnjenja

Naravno odvajanje toplote



### Hitro polnjenje



### Čakanje na polnjenje

Nizka stopnja samo izpraznjenja



### Optimalni sistem polnjenja

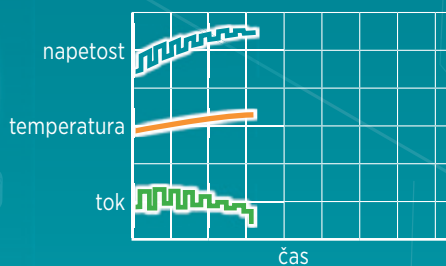

### Običajni sistem polnjenja

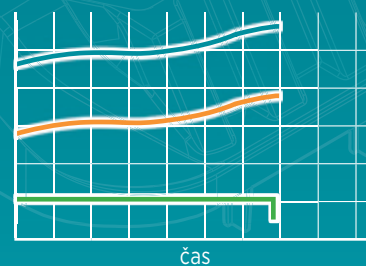

## FUNKCIJA ZAŠČITE AKUMULATORJA

Komunikacijska tehnologija, ki orodju in akumulatorju omogoča spremljanje pogojev in izmenjavo podatkov, zaščiti akumulator pred preobremenitvijo, prekomernim praznjenjem in pregrevanjem.



### Polnjenje kadarkoli

Brez spominskega učinka. Ni potrebno predhodno praznjenje akumulatorja.



### Močan drsni priklop

Več-točkovni priklop zmanjša električni upor in izboljša stik tudi pri močnejših vibracijah, ter s tem zagotavlja stabilen dovod električnega toka.















### Blažnje udarcev

Trdna konstrukcija ščiti akumulator pred poškodbami.



# Litij-ionski akumulatorji in polnilniki s časi polnjenja

		<b>FAST Charging</b> DC40RA	<b>FAST Charging</b> DC40RB*	DC40RC	<b>FAST Charging</b> DC18RC	DC18SD	DC18SF kompatibilen z LXT serijo akumulatorjev	DC18WC	
		 ADP10 adapter za LXT akumulatorje		 ADP10 adapter za LXT akumulatorje	 DC18RD*  DC18RE**	 DC18SH*  DC18SE avtomobilski		1-2 akumulatorja	3-4 akumulatorji
<b>XGT</b> 40V max Litij-ion	5,0Ah BL4050F	50 min	50 min	85 min	-	-	-	-	-
	4,0Ah BL4040	45 min	45 min	67 min	-	-	-	-	-
	2,5Ah BL4025	28 min	28 min	38 min	-	-	-	-	-
	2,0Ah BL4020	22 min	22 min	30 min	-	-	-	-	-
<b>LXT</b> 18V Litij-ion	6,0Ah BL1860B	DC40RA + ADP10 40 min	-	DC40RC + ADP10 85 min	55 min	130 min	130 min	260 min	165 min
	5,0Ah BL1850B	DC40RA + ADP10 35 min	-	DC40RC + ADP10 70 min	45 min	110 min	110 min	220 min	145 min
	4,0Ah BL1840B	DC40RA + ADP10 29 min	-	DC40RC + ADP10 58 min	36 min	90 min	90 min	180 min	115 min
	3,0Ah BL1830B	DC40RA + ADP10 22 min	-	DC40RC + ADP10 42 min	22 min	60 min	60 min	120 min	85 min
	2,0Ah BL1820B	DC40RA + ADP10 24 min	-	DC40RC + ADP10 33 min	24 min	45 min	45 min	90 min	58 min
	1,5Ah BL1815N	DC40RA + ADP10 15 min	-	DC40RC + ADP10 22 min	15 min	30 min	30 min	60 min	43 min

		<b>FAST Charging</b> DC10SB	DC10WD			DC18WA	DC18WB			DC64WA
										
<b>CXT</b> 12V max Litij-ion	4,0Ah BL1041B	60 min	130 min	18V Litij-ion 14,4V Litij-ion	1,5Ah BL1815G BL1415G	70 min	80 min	64V max Litij-ion	4,0Ah BL6440	120 min
	2,0Ah BL1021B	30 min	70 min			90 min	105 min			
	1,5Ah BL1016	22 min	50 min							

<b>PDC1200A01</b> 	<b>DC4001</b> 	<b>PDC01</b> 
<b>40V max</b> Litij-ion	<b>360 min</b>	<b>40V max</b> Litij-ion
<b>18V x2</b> Litij-ion		<b>18V/18V x2</b> Litij-ion
		napaja se z največ 4 18V LXT akumulatorji

\*DC40RB/DC18RD/DC18SH: polnilniki z dvema priklopoma

\*\*DC18RE: polnilnik za LXT in CXT akumulatorje

 indikator napolnenosti **FAST Charging** hitro polnjenje





## Polnilni seti

**40 V max**  
Litij-ion

**18 V**  
Litij-ion

**12 V max**  
Litij-ion

Koda	Makpac kovček	Set vsebuje			
		Akumulator	Kapaciteta	Količina	Polnilnik
191J81-6	Tip 1	BL4025	2,5 Ah	2	DC40RA
191J97-1	Tip 1	BL4040	4,0 Ah	2	DC40RA
191U00-8	Tip 3	BL4040	4,0 Ah	2	DC40RB
191U28-6	Tip 3	BL4040	4,0 Ah	4	DC40RB
191U13-9	Tip 3	BL4050F	5,0 Ah	2	DC40RB
191U42-2	Tip 3	BL4050F	5,0 Ah	4	DC40RB
197570-9	—	BL1850B	5,0 Ah	2	DC18RC
197952-5	Tip 1	BL1830B	3,0 Ah	2	DC18RC
197954-1	Tip 1	BL1830B	3,0 Ah	4	DC18RC
199697-1	Tip 1	BL1850B	5,0 Ah	8	—
198116-4	Tip 1	BL1860B	6,0 Ah	2	DC18RC
197970-3	Tip 2	BL1830B	3,0 Ah	4	DC18RD
197503-4	Tip 3	BL1840B	4,0 Ah	4	DC18RD
197504-2	Tip 3	BL1840B	4,0 Ah	2	DC18RD
197626-8	Tip 3	BL1850B	5,0 Ah	4	DC18RD
197629-2	Tip 3	BL1850B	5,0 Ah	2	DC18RD
198077-8	Tip 3	BL1860B	6,0 Ah	2	DC18RD
198091-4	Tip 3	BL1860B	6,0 Ah	4	DC18RD
197136-5	Tip 1	BL1815N	1,5 Ah	2	DC18SD
197652-7	Tip 1	BL1016	1,5 Ah	2	DC10SB
197658-5	Tip 1	BL1021B	2,0 Ah	2	DC10SB
197641-2	Tip 1	BL1041B	4,0 Ah	2	DC10SB

# Akumulatorji in polnilniki

Model	Koda	Kapaciteta	Napetost	Teža
-------	------	------------	----------	------

## XGT - 40V max



BL4050F	191L47-8	5,0 Ah	40 V	1,30 kg
BL4040	191B26-6	4,0 Ah	40 V	1,00 kg
BL4025	191B36-3	2,5 Ah	40 V	0,71 kg
BL4020	632R35-7	2,0 Ah	40 V	0,69 kg

## LXT - 18V



BL1860B	632F69-8	6,0 Ah	18 V	0,66 kg
BL1850B	632F15-1	5,0 Ah	18 V	0,63 kg
BL1840B	632F07-0	4,0 Ah	18 V	0,64 kg
BL1830B	632G12-3	3,0 Ah	18 V	0,64 kg
BL1820B	632F01-2	2,0 Ah	18 V	0,39 kg
BL1815N	632A54-1	1,5 Ah	18 V	0,38 kg

## CXT - 12V max



BL1041B	632F63-0	4,0 Ah	12 V	0,37 kg
BL1021B	632F59-1	2,0 Ah	12 V	0,21 kg
BL1016	632F55-9	1,5 Ah	12 V	0,21 kg

## 64V - max



BL6440	191R06-8	4,0 Ah	64 V	2,2 kg
--------	----------	--------	------	--------

## G-serija - 14,4 / 18V



BL1820G	191N69-0	2,0 Ah	18 V	0,39 kg
BL1420G	191N76-3	2,0 Ah	14,4 V	0,33 kg
BL1815G	198186-3	1,5 Ah	18 V	0,39 kg
BL1415G	198192-8	1,5 Ah	14,4 V	0,33 kg

## Ostali akumulatorji - 7,2 / 10,8 / 14,4V



BL1440B	632C17-9	4,0 Ah	14,4 V	0,52 kg
BL1430B	632G20-4	3,0 Ah	14,4 V	0,5 kg
BL1013	196066-7	1,3 Ah	10,8 V	0,17 kg
BL0715	198000-3	1,5 Ah	7,2 V	0,12 kg

## Nahrtni akumulator



Koda	Moč	Kapaciteta	Napetost	Teža
PDCI200A01	1.206 Wh	33,5 Ah	36 V	10,40 kg
191A64-2	432 Wh	12/24 Ah	18 / 36 V	7,0 kg

Model	Koda	Napetost	Vhodna napetost
-------	------	----------	-----------------

## XGT - 40V max



DC40RA	191E07-8	40 V	230 V
DC40RC	191M90-3	40 V	230 V
DC40RB	191N09-8	40 V	230 V

## LXT - 18V



DC18WC	1910G0-1	14,4-18 V	230 V
DC18SD	194533-6	14,4-18 V	230 V
DC18SE	194621-9	14,4-18 V	12-24 V
DC18SF	196426-3	14,4-18 V	230 V
DC18RE	198720-9	12 max CXT/ 14,4-18 LXT V	230 V
DC18RC	630718-5	14,4-18 V	230 V
DC18RD	630868-6	14,4-18 V	230 V
DC18SH	630B24-0	14,4-18 V	230 V

## CXT - 12V max



DC10WD	197343-0	10,8-12 V	230 V
DC18RE	198720-9	12 max CXT/ 14,4-18 LXT V	230 V
DC10SB	630996-7	10,8-12 V	230 V

## 64V - max



DC64WA	191W19-9	64 V	230 V
--------	----------	------	-------

## G-serija - 14,4 / 18V



DC18WB	191W37-7	14,4-18 V	230 V
DC18WA	195423-6	14,4-18 V	230 V

## Ostali polnilniki



DC10WA	194588-1	7,2-10,8 V	230 V
--------	----------	------------	-------



# NAHRBTNA ADAPTERJA PDC1200 IN PDC01

## PDC1200

### PDC1200A01

Z integriranimi baterijskimi celicami



33,5 Ah

Kapaciteta



1.206 Wh

Moč



1,1 m

Dolžina kabla



PDC1200



### Vmesni priključek

Akumulatorska orodja z direktnim priključkom



### 191N62-4

XGT adapter 40 V max



## PDC01

### 191A64-2

Uporaba z LXT 18 V akumulatorji

Možnost priklopa do 4 LXT akumulatorjev



24 Ah  
12 Ah

Kapaciteta



432 Wh

Moč



1,7 m

Dolžina kabla



PDC01



### 191J51-5

LXT adapter 18 + 18 V



### 191A53-7

LXT adapter 18 V



## Akumulatorji

## Zaščite za akumulatorje

	Koda	Naziv	Za model	Cena z DDV
	194649-7	Ščitnik akumulatorja BDF, BHP, BTD	BL1430B, BL1440, BL1450, BL1460B, BL1830B, BL1840B, BL1850B, BL1860B	
	195798-3	Zaščita ohišja BL18XX	DDF458, DHP458, DTD146	
	422807-8	Zaščita akumulatorja	DBO380, DBO381	
	450128-8	Pokrov akumulatorja Li-ion 14,4/18V	BL1415, BL1430, BL1440, BL1815, BL1820, BL1830, BL1840, BL1850, BL1860	
	450599-9	Zaščita ohišja akumulatorja	BL1430	



## Adapterji

### Adapterji

Koda	Naziv	Model	Opis	Cena z DDV	
SE00000101	Polnilnik za akumulatorski radio	/	Primeren za DMR103B, DMR106(B), DMR108		
198634-2	Priklop za akumulator jakne LXT 14,4V in 18V	/	Priklop za akumulator za hlajenje jakne		
198639-2	Priklop za akumulator jakne CXT 12V max	/	Priklop za akumulator za hlajenje jakne		
YL00000003	CXT adapter za akumulator jakne in odeje za ogrevanje	/	Priklop za CXT akumulator za ogrevanje jakne in odeje		
YL00000004	Adapter za LXT akumulator za grelne jakne in odeje	/	Priklop za LXT akumulator za ogrevanje jakne in odeje		
SE00000078	Polnilnik za akumulatorski radio	/	Primeren za BMR100, DMR102, DMR107, DMR116, MR001G		
TE00000442	Polnilnik za ventilator	/	Primeren za DCF301, CF002G		
SE00000265	Polnilnik za akumulatorski radio	/	Primeren za DMR110, MG002G, MR003G		
SE00000679	Polnilnik za akumulatorski radio DMR114	/	Primeren za DMR114, MG004G		
SE00000501	Pretvornik napetosti DMR200	/	Primeren za DMR200, DMR202, DMR201		
TC00000137	Polnilnik za akumulatorski radio	/	Primeren za DMR300, DMR301		
TC00000142	AC kabel	/	Primeren za DMR300, DMR301		

[Nadaljevanje...](#)

Akumulat  
orji in  
polnilniki

Pribor za  
akumulat  
orsko  
orodje

Akumulat  
orske  
svetilke  
in pribor

Pribor za  
lasarske  
merilnike

Pribor za  
rušenje  
in vrtanje

Pribor za  
vrtanje

Kronske  
žage

Pribor za  
vijačenje

Pribor za  
rezanje  
in  
brušenje

Pribor za  
poliranje  
in  
brušenje

Pribor za  
rezkanje  
in  
oblanje

Pribor za  
multifunk  
cijsko  
orodje

Pribor za  
žaganje

Pribor za  
žebjalnike  
in  
spenjalnike

Pribor za  
fene

Pribor za  
sesanje

Pribor  
orodja za  
uporabo  
na prostem

Pribor za  
hidro  
orodja in  
zaščitna  
oprema

Kovčki in  
torbe za  
orodje

Ročno  
orodje

Razno

Pribor za  
mešanje

## Akumulatorji in polnilniki

	Koda	Naziv	Model	Opis	Cena z DDV
	ADP001G	Adapter USB dvojni polnilnik 40V MAX XGT	ADP001G	Polnilni adapter - USB za polnjenje dveh mobilnih naprav (5 V/2,4 A na USB-izhodu) za XGT Li-ion akumulatorje 40 V	
	193682-6	Adapter za osvežitev	ADP03	Primeren za DC18RA/SE/RC, DC24SC	
	DECADP05	Adapter USB-polnilnik	ADP05	Polnilni adapter - USB za polnjenje dveh mobilnih naprav (5 V/2,1 A na USB-izhodu) za LXT Li-ion akumulatorje 14,4 V/18 V	
	ADP06	CXT adapter USB 12V max-polnilnik za telefon	ADP06	Polnilni adapter - USB za polnjenje ene mobilne naprave (5 V/2,1 A na USB izhodu) za CXT Li-ion akumulatorje 12V max	
	191C10-7	Adapter XGT - za LXT akumulatorje	ADP10	Primeren za DC40RA, DC40RC	
	197580-6	Adapter za akumulator 2x18V BAP182	BAP182	Zunanje držalo akumulatorja za 2 x 18V aku.	
	193689-2	Zunanje držalo akumulatorja	BAP24	Zunanje držalo akumulatorja - za akumulatorje MAKSTAR 24 V	
	195511-9	Adapter BCV01 za dva 18V akumulatorja	BCV01	Zunanje držalo za akumulatorje - za 2 x BL1830 primerno za 36 V naprave	
	197214-1	Adapter BCV03 za dva 18V akumulatorja	BCV03	Adapter za akumulatorje - povezuje 2 x 18 V v 1 x 36 V akumulator	
	YL0000068	Podaljševalni kabel 1,5m	DCB200, CB100D		
	198900-7	AWS brezžični vmesnik	WUT01	Primeren za orodja z AWS funkcijo.	
	199742-2	Adapter za brezžično odsesavanje WUT02Z	WUT02	Adapter za električne sesalce z avtomatsko funkcijo.	
	199790-1	Adapter za brezžično odsesavanje WUT02U, z WUT01	WUT02 + WUT01		

# PRIBOR ZA AKUMULATORSKO ORODJE





# IDEALEN PRIBOR ZA AKUMULATORSKO ORODJE



## **Optimalno delo z akumulatorskimi orodji!**

Večje hitrosti, večja količina opravljenega dela z enim polnjenjem akumulatorja in gladko delovanje.  
Priporočen pribor za akumulatorsko orodje najdete s pomočjo 8 akumulatorskih ikon.

## Akumulatorski vijačniki

### Zaščite za DFL in DFT modele

Koda	Naziv	Za model	Cena z DDV	
418032-7	Ščitnik, rumen	DFL061F, DFL062F, DFL063F, DFL082F, DFL083F, DFL201F, DFL124F, DFL125F, DFL203F, DFL204F		
418064-4	Ščitnik, moder	DFL061F, DFL062F, DFL063F, DFL082F, DFL083F, DFL201F, DFL124F, DFL125F, DFL203F, DFL204F		
418065-2	Ščitnik, rdeč	DFL061F, DFL062F, DFL063F, DFL082F, DFL083F, DFL201F, DFL124F, DFL125F, DFL203F, DFL204F		
418423-2	Ščitnik, rumen	DFT082F, DFT082R, DFT083F, DFT124F, DFT125F		
418424-0	Ščitnik, moder	DFT082F, DFT082R, DFT083F, DFT124F, DFT125F		
418425-8	Ščitnik, rdeč	DFT082F, DFT082R, DFT083F, DFT124F, DFT125F		
418743-4	Ščitnik, moder	DFL301R, DFL402F		
418744-2	Ščitnik, rdeč	DFL301R, DFL402F		
418745-0	Ščitnik, prozoren	DFL301R, DFL402F		
418746-8	Ščitnik, moder	DFL301R, DFL402F		
418750-7	Ščitnik, rdeč	DFL301R, DFL402F		
450331-1	Ščitnik, prozoren	DFT082F, DFT082R, DFT083F, DFT124F, DFT125F		

Akumulat  
orj in  
poinliki

Pribor za  
akumulat  
orsko  
orodje

Akumulat  
orske  
svetilke  
in pribor

Pribor za  
lasarske  
merilnike

Pribor za  
rušenje  
in vrtanje

Pribor za  
vrtanje

Kronske  
žage

Pribor za  
vijačenje

Pribor za  
rezanje  
in  
brušenje

Pribor za  
poliranje  
in  
brušenje

Pribor za  
rezkanje  
in  
oblanje

Pribor za  
multifunk  
cijsko  
orodje

Pribor za  
žaganje

Pribor za  
žebjalnike  
in  
spenjalnike

Pribor za  
fene

Pribor za  
sesanje

Pribor  
orodja za  
uporabo  
na prostem

Pribor za  
ročna  
orodja in  
zaščitna  
oprema

Kovčki in  
torbe za  
orodje

Ročno  
orodje

Razno

Pribor za  
mešanje

# Pribor za akumulatorsko orodje



## Pribor za akumulatorske kotne udarne vijačnike

	Koda	Naziv	Za model	Cena z DDV
	134743-3	Natični ključ 17mm za ragljo 192439-2	6940D, DTL060, DTL061, TL064D, TL065D	
	134744-1	Natični ključ 19mm za ragljo 192439-2	6940D, DTL060, DTL061, TL064D, TL065D	
	134745-9	Adapter za natični ključ 3/8" za ragljo 192439-2	6940D, DTL060, DTL061, TL064D, TL065D	
	134746-7	Adapter za natični ključ 1/2" za ragljo 192439-2	6940D, DTL060, DTL061, TL064D, TL065D	
	135183-8	Kotna glava za 1/4" vijačne nastavke	6940D, DTL060, DTL061, TL064D, TL065D	
	135200-4	Kotna glava za 25mm 1/4" vijačne nastavke	6940D, DTL060, DTL061, TL064D, TL065D	
	135201-2	Kotna glava za 3/8" natične ključe	6940D, DTL060, DTL061, TL064D, TL065D	
	192439-2	Glava za ragljo 21mm	6940D, DTL060, DTL061, TL064D, TL065D	
	192440-7	Ravna glava za 1/4" vijačne nastavke	6940D, DTL060, DTL061, TL064D, TL065D	

## Omejevalec globine

	Koda	Naziv	Za model	Cena z DDV
	194280-9	Omejilnik globine	DTD152, DTD153, DTD154, DTD155, DTD157, TD001G, TD111D	

[Nadaljevanje...](#)





# Pribor za akumulatorsko orodje

Koda	Naziv	Za model	Cena z DDV	
194281-7	Omejilnik globine z adapterjem in vijačnim nastavkom	DTD152, DTD153, DTD154, DTD155, DTD157, TD001G, TD111D		

## Akumulatorski ragljasti vijačnik



### Pribor



Koda	Naziv	Vpetje	Za model	Cena z DDV	
191A50-3	Adapter 9.5	3/8"	WR100D, DWR180		
191A51-1	Adapter 6.35	1/4"	WR100D, DWR180		

- Akumulatorji in polnilniki
- Pribor za akumulatorsko orodje
- Akumulatorske svetilke in pribor
- Pribor za laserske merilnike
- Pribor za rušenje in vrtanje
- Pribor za vrtanje
- Kronske žage
- Pribor za vijačenje
- Pribor za rezanje in brušenje
- Pribor za poliranje in brušenje
- Pribor za rezkanje in oblanje
- Pribor za multitfunkcijsko orodje
- Pribor za žaganje
- Pribor za žebjalnike in spenjalnike
- Pribor za fene
- Pribor za sesanje
- Pribor za uporabo na prostem
- Pribor za varnostno opremo
- Kovčki in torbe za orodje
- Ročno orodje
- Razno
- Pribor za mešanje

## Akumulatorska pištola za mast



## Pribor

	Koda	Naziv	Za model	Cena z DDV
	166094-6	Ramenski pas	DUB362, DVC350, BVC340, BVC350, DUB184, DGP180, UB001G	
	191A76-5	Zapirni adapter za DGP180	DGP180	
	191A77-3	Kotni adapter za DGP180	DGP180	
	191A78-1	Adapter 3kos/pk DGP180	DGP180	
	191A79-9	Mazalna cev 1200 mm DGP180	DGP180	
	191A80-4	Mazalna cev 600 mm DGP180	DGP180	
	191A81-2	Rezervoar B za DGP180 450 g	DGP180	
	191B12-7	Rezervoar A za DGP180 400 g	DGP180	

# Pribor za akumulatorsko orodje

19

## Akumulatorski puhalnik za prah



### Pribor

Koda	Naziv	Opis	Premer	Slike
191X11-1	Šoba 3	Šoba za pihanje zraka v omejene prostore, vogale in površine ob stenah za odstranjevanje prahu.	3 mm	
191X13-7	Šoba 7	Šoba za odstranjevanje prahu s filtrov.	7 mm	
191X15-3	Šoba 13	Šoba za čiščenje delovnih površin, splošno izpihovanje prahu, čiščenje sidrnih lukenj (z uporabo dolgih šob), napihovanje velikih napihljivih predmetov in praznjenje le teh.	13 mm	
191X17-9	Šoba s potisnim ventilom	Šoba za napihovanje/praznjenje igrač za plažo, žog, blazin in podobnih izdelkov.	7 mm	
191X19-5	Šoba s širokim curkom	Šoba za izpihovanje umazanije in tekočin z delovnih miz ter širokih in odprtih površin. Kot pihanja je 120° s 5 odprtinami.	6 mm (posamezna odprtina)	
191X21-8	Gibljiva šoba 6	Gibljiva cev s šobo za izpihovanje prahu iz težko dostopnih mest, elektronske opreme in ostalih naprav.	6 mm	
191X23-4	Komplet odsesovalne cevi	Odsesovalna cev za praznjenje napihljivih izdelkov s pomočjo ustreznih šob.	/	
191X25-0*	Gumijast priključek 20 - 30	Šoba primerna za praznjenje napihljivih ležišč, raftov, čolnov, bazenov in ostalih podobnih izdelkov.	20 mm - 30 mm	
191X27-6*	Gumijast priključek 65	Priključek je primeren za pakiranje oblačil z izsesavanjem zraka.	65 mm	
191X29-2	Filter C	Filter, zasnovan za maksimalno zmanjšanje vdora prahu v motor v prašnem delovnem okolju.	/	
191X78-9*	Komplet dolgih šob	Komplet šob, ki so primerne za izpihovanje sidrnih lukenj in ostalih ozkih mest. dolžino posameznih šob je mogoče spremeniti s pritrdjevanjem in odstranjevanjem dveh glav šobe.	8 mm	

\*Za uporabo priključka, mora biti predhodno nameščena odsesovalna šoba 13.

Akumulatorji in polnilniki

Pribor za akumulatorsko orodje

Akumulatorske svetilke in pribor

Pribor za laserske merilnike

Pribor za rušenje in vrtanje

Pribor za vrtanje

Kronске žage

Pribor za vijčenje

Pribor za rezanje in brušenje

Pribor za poliranje in brušenje

Pribor za rezkanje in oblanje

Pribor za multitfunkcijsko orodje

Pribor za žaganje

Pribor za žebjalnike in spenjalnike

Pribor za fene

Pribor za sesanje

Pribor za uporabo na prostem

Pribor za nošenje in zaščitna oprema

Kovčki in torbe za orodje

Ročno orodje

Razno





Pribor za mešanje



## Akumulatorska vakuumska črpalka za klime DVP180



## Pribor za akumulatorsko vakuumsko črpalko

	Koda	Naziv	Za model	Cena z DDV
	AS000VP042	Pas za nošenje kovčka	DVP180	
	AS00VP050M	Olje za vakuumsko črpalko (150ml)	DVP180	
	AS00XP808M	Manometer	DVP180	
	AS0AI154MK	Cev za vakumiranje	DVP180	
	AS0VP007MK	Alu kovček	DVP180	
	AS0VP051MK	Ventil pretoka zraka z manometrom	DVP180	
	AS0Y06110K	Adapter	DVP180	

# Pribor za akumulatorsko orodje

## Akumulatorski kovičniki



### Pribor

Koda	Naziv	Premer kovice (mm)	Za model	Enota (kos/set)	Cena z DDV	
162500-9	Zbiralna posoda	/	DRV150, DRV250	1		
191D57-7	Mast	/	DRV150, DRV250	1		
199729-4	Set pribora 2.4	2.4	DRV150, DRV250	1		
199731-7	Čeljust zakovic 4.8	2.4 - 4.8	DRV150, DRV250	3/1		
199728-6	Set pribora 3.2	3.2	DRV150, DRV250	1		
191C04-2	Set pribora B 4.0	4.0	DRV150, DRV250	1		
191F80-4	Set pribora A 4.0	4.0	DRV250	1		
191C03-4	Set pribora B 4.8	4.8	DRV150, DRV250	1		
191F79-9	Set pribora A 4.8	4.8	DRV250	1		
199726-0	Set pribora A 4.8	4.8	DRV250	1		
199730-9	Čeljust zakovic 6.4	4.8 - 6.4	DRV250	3/1		

Nadaljevanje...

Akumulatorji in polnilniki

Pribor za akumulatorsko orodje

Akumulatorske svetilke in pribor

Pribor za laserske merilnike

Pribor za rušenje in vrtanje

Pribor za vrtanje

Kronske žage

Pribor za vijachenje

Pribor za rezanje in brušenje

Pribor za poliranje in brušenje

Pribor za rezkanje in oblanje

Pribor za multitank ciljsko orodje

Pribor za žaganje

Pribor za žebjalnike in spenjalnike

Pribor za fene

Pribor za sesanje

Pribor orodja za uporabo na prostem

Pribor za čiščenje orodja in zaščitna oprema

Kovčki in torbe za orodje

Ročno orodje

Razno orodje

Pribor za mešanje



# Pribor za akumulatorsko orodje

	Koda	Naziv	Premer kovice (mm)	Za model	Enota (kos/set)	Cena z DDV
	199725-2	Set pribora 6.0	6.0	DRV250	1	
	191F78-1	Set pribora 6.4	6.4	DRV250	1	

## Akumulatorske tesnilne pištole

### Držala kartuš



	Koda	Naziv	Volumen (l)	Za model	Cena z DDV
	123221-8	Bat C za 600 ml kartušo	/	CG100D, DCG180	
	141861-0	Držalo kartuše 600 ml	/	CG100D, DCG180	
	142041-1	Podajalna palica za 300 ml kartušo	/	CG100D, DCG180	
	142042-9	Podajalna palica za 600 ml kartušo	/	CG100D, DCG180	
	142071-2	Bat A za 300 ml in 600 ml kartušo	/	CG100D, DCG180	
	142072-0	Bat B za 600 ml kartušo	/	CG100D, DCG180	
	191P89-6	Držalo kartuše D za akumulatorsko tesnilno pištolo	0,4	CG100D, DCG180	
	196351-8	Držalo kartuše A za akumulatorsko tesnilno pištolo	0,3	CG100D, DCG180	
	196352-6	Držalo kartuše B za akumulatorsko tesnilno pištolo	0,6	CG100D, DCG180	
	318958-2	Pritrdilni obroč B	/	CG100D, DCG180	
	454223-6	Pritrdilno obroč za 300 ml nastavak kartuše	/	CG100D, DCG180	
	454226-0	Šoba kartuše 600 ml	/	CG100D, DCG180	

Nadaljevanje...





# Pribor za akumulatorsko orodje

Koda	Naziv	Volumen (l)	Za model	Cena z DDV	
454275-7	Držalo kartuše 300 ml	/	CG100D, DCG180		

## Akumulatorski vezalec armature



### Pribor

Koda	Naziv	Premer (Ø) (mm)	Celotna dolžina (m)	Za model	Enota (kos/set)	Cena z DDV	
162755-6	Najlonska čistilna krtača	/	/	DTR180	1		
191M27-0	Podaljševalni ročaj za vezalec armature DTR180	/	0,175	DTR180	1		
199137-9	Žica za zavezovanje	8	100	DTR180	50/1		

Akumulat  
orjji in  
poinliniki

Pribor za  
akumulat  
orsko  
orodje

Akumulat  
orske  
svetilke  
in pribor

Pribor za  
lasarske  
merilnike

Pribor za  
rušenje  
in vrtanje

Pribor za  
vrtanje

Kronske  
žage

Pribor za  
vijačenje

Pribor za  
rezanje  
in  
brušenje

Pribor za  
poliranje  
in  
brušenje

Pribor za  
rezkanje  
in  
oblanje

Pribor za  
multifunk  
ciljsko  
orodje

Pribor za  
žaganje

Pribor za  
žebjalnike  
in  
spenjalnike

Pribor za  
fene

Pribor za  
sesanje

Pribor  
orodja za  
uporabo  
na prostem

Pribor za  
pomoč je  
orodja in  
zaščitna  
oprema

Kovčki in  
torbe za  
orodje

Ročno  
orodje





Razno

Pribor za  
mešanje

## Akumulatorski rezalniki navojnih palic



## Pribor za DSC102, SC103D

	Koda	Naziv	Tip vijaka	Za model	Cena z DDV
	199069-0	Ramenski pas	/	DSC102, SC103D	
	199083-6	Set rezil M10	M10	DSC102, SC103D	
	199085-2	Set rezil M8	M8	DSC102, SC103D	
	199087-8	Set rezil M6	M6	DSC102, SC103D	



## Pribor za DSC121

	Koda	Naziv	Tip vijaka	Za model	Cena z DDV
	SC09002700	Nož M8 DSC121	M8	DSC121	
	SC09002710	Nož M10 DSC121	M10	DSC121	
	SC09002720	Nož M12 DSC121	M12	DSC121	

[Nadaljevanje...](#)

# Pribor za akumulatorsko orodje

Koda	Naziv	Tip vijaka	Za model	Cena z DDV	
SC09002730	Nož W3/8 DSC121	3/8"	DSC121		

## Akumulatorski rezalnik armaturnih palic



### Rezila



Koda	Naziv	Za model	Cena z DDV	
SC09002470	Set rezil	DSC163		

## Akumulatorska rezalnika železnih armatur



### Rezila

Za DSC250 poleg lista SC09003260, potrebujete še distančnik SC09030550.

Koda	Naziv	Žagin list (Ø) (mm)	Luknja žaginega lista (Ø) (mm)	Število zob	Največje število obratov (min <sup>-1</sup> )	Za model	Cena z DDV	
SC09002890	TCT žagin list	110	15	24	2.200	DSC250		
SC09003260	TCT žagin list	110	15	24	2.200	DSC250, DSC251		
SC09030550	Distančnik	/	/	/	/	DSC250, DSC251		



Akumulatorji in polnilniki  
 Pribor za akumulatorsko orodje  
 Akumulatorske svetilke in pribor  
 Pribor za laserske merilnike  
 Pribor za rušenje in vrtanje  
 Pribor za vrtanje  
 Kronske žage  
 Pribor za vijčenje  
 Pribor za rezanje in brušenje  
 Pribor za poliranje in brušenje  
 Pribor za rezkanje in oblanje  
 Pribor za multitank cijsko orodje  
 Pribor za žaganje  
 Pribor za žebjalnike in spenjalnike  
 Pribor za fene  
 Pribor za sesanje  
 Pribor za uporabo na prostem  
 Pribor za varnostno opremo  
 Kovčki in torbe za orodje  
 Ročno orodje  
 Razno  
 Pribor za mešanje



## Akumulatorski rezalniki



## Pribor

	Koda	Naziv	Za model	Cena z DDV
	126738-0	Vrečka za prah	4100KB, DCC500	
	191N83-6	Protiprašni pokrov z vrečko za prah DCC500	DCC500	
	191X01-4	Set za hlajenje DCC500	DCC500	

## Akumulatorski večnamenski rezalnik



## Rezila

	Koda	Naziv	Za model	Cena z DDV
	198603-3	Nož za aku večnamenski rezalnik	CP100D	

# Pribor za akumulatorsko orodje

27

## Akumulatorske zračne tlačilke



### Pribor

Koda	Naziv	Maks. tlak (bar)	Za model	Cena z DDV	
TE00000592	Nastavek za žoge	0,9	MP100, DMP180, DMP181, MP001G		
TE00000346	Britanski adapter	3	MP100, DMP180, DMP181, MP001G		
TE00000333	Adapter za blazine	0,5	MP100, DMP180, DMP181, MP001G		
TE00000334	Francoski adapter	7	MP100, DMP180, DMP181, MP001G		

## Akumulatorski suhomontažni žagi



### Pribor

Globino reza je mogoče prilagoditi debelini mavčne plošče.

Koda	Material rezila	Celotna dolžina (mm)	Širina (mm)	Debelina rezila (mm)	Primerno za	Za model	Enota (kos/set)	Cena z DDV	
456624-4	/				/	DSD180, SD100D	1		
B-49703	HCS	55	18	0,55	mavčne plošče	DSD180, SD100D	2/1		
B-49703-10	HCS	55	18	0,55	mavčne plošče	DSD180, SD100D	10/1		
B-49719	HCS	55	18	0,55	les	DSD180, SD100D	2/1		

Akumulat  
orodje in  
pomočniki

Pribor za  
akumulat  
orsko  
orodje

Akumulat  
orske  
svetilke  
in pribor

Pribor za  
laserske  
merilnike

Pribor za  
rušenje  
in vrtanje

Pribor za  
vrtanje

Kronske  
žage

Pribor za  
vijačenje

Pribor za  
rezanje  
in  
brušenje

Pribor za  
poliranje  
in  
brušenje

Pribor za  
rezkanje  
in  
oblanje

Pribor za  
multifunk  
cijsko  
orodje

Pribor za  
žaganje

Pribor za  
žebjalnike  
in  
spenjalnike

Pribor za  
fene

Pribor za  
sesanje

Pribor  
orodja za  
uporabo  
na prostem

Pribor za  
kroglje  
in  
zaščitna  
oprema

Kovčki in  
torbe za  
orodje

Ročno  
orodje









Razno

Pribor za  
mešanje

## Akumulatorski brusilnik za stene



## Pribor

	Koda	Naziv	Premer (Ø) (mm)	Mere (D x Š x V) (mm)	Za model	Cena z DDV
	140J85-5	Ščetka A	/	/	DSL800	
	140J86-3	Ščetka B	/	/	DSL800	
	195638-5	Torba za orodje		1.200 x 300 x 350	DSL800, DSL801, DUX60, UX01G, DUX18	
	199937-7	Set podaljška z ročajem	/	800	DSL800, DSL801	
	199938-5	Podporni krožni trd	220	/	DSL800, DSL801	
	199939-3	Podporni krožni mehak	210	/	DSL800, DSL801	
	199940-8	Podporni krožni srednji	210	/	DSL800, DSL801	
	743127-0	Ščetka	/	/	DSL801	

Akumulatorji in polnilniki  
 Pribor za akumulatorsko orodje  
 Akumulatorske svetilke in pribor  
 Pribor za laserske merilnike  
 Pribor za rušenje in vrtanje  
 Pribor za vrtanje  
 Kronske žage  
 Pribor za vijačenje  
 Pribor za rezanje in brušenje  
 Pribor za poliranje in brušenje  
 Pribor za rezkanje in oblanje  
 Pribor za multifunkcijsko orodje  
 Pribor za žaganje  
 Pribor za žebjalnike in spenjalnike  
 Pribor za fene  
 Pribor za sesanje  
 Pribor za orodja za uporabo na prostem  
 Pribor za nosenje orodja in zaščitna oprema  
 Kovčki in torbe za orodje  
 Ročno orodje  
 Razno  
 Pribor za mešanje



# Pribor za akumulatorsko orodje





## Brusni papir

Koda	Premer (Ø) (mm)	Zrnatost	Število lukenj	Pritrjevanje na ježka	Za model	Enota (kos/set)	Cena z DDV
B-68389	225	40	9	•	DSL800	25/1	
B-68395	225	80	9	•	DSL800	25/1	
B-68404	225	120	9	•	DSL800	25/1	
E-02375	225	150	9	•	DSL800	25/1	
B-68410	225	180	9	•	DSL800	25/1	
E-02381	225	220	9	•	DSL800	25/1	
B-68426	225	320	9	•	DSL800	25/1	

## Pribor za polirnike















### Pribor za poliranje

Koda	Naziv	Premer (Ø) (mm)	Opis	Za model	Cena z DDV	
191N90-9	Penasta polirna plošča 80 mm rumena	80	Penasta polirna plošča za nanašanje voska	DPV300, PV301D		
191N91-7	Penasta polirna plošča 80 mm bela	80	Penasta plošča za odstranjevanje voska	DPV300, PV301D		
191N92-5	Volnena prevleka 80 mm	80	Volnena prevleka za poliranje do visokega leska z voskom	DPV300, PV301D		
743125-4	Podporni krožnik za polirne prevleke 80 mm	75		DPV300, PV301D		

- Akumulatorji in polnilniki
- Pribor za akumulatorsko orodje
- Akumulatorske svetilke in pribor
- Pribor za lasarske mešanice
- Pribor za rušenje in vrtanje
- Pribor za vrtanje
- Kronske žage
- Pribor za vijačenje
- Pribor za rezanje in brušenje
- Pribor za poliranje in brušenje
- Pribor za rezanje in oblanje
- Pribor za multitfunkcijsko orodje
- Pribor za žaganje
- Pribor za žebjalnike in spenjalnike
- Pribor za fene
- Pribor za sesanje
- Pribor za uporabo na prostem
- Pribor za varnostno opremo
- Kovčki in torbe za orodje
- Ročno orodje
- Razno
- Pribor za mešanje

# Pribor za akumulatorsko orodje

## Pribor za brušenje

	Koda	Naziv	Premer (Ø) (mm)	Pritrjevanje na ježka	Zrnatost	Zrnatost plošče	Tip	Za model	Enota (kos/ set)	Gena z DDV
	743124-6	Podporni krožnik za polirne prevleke	46	/	/	/	/	DPV300, PV301D	1	
	743126-2	Adapter za podporni krožnik 743124-6	/	/	/	/	/	DPV300, PV301D	1	
	E-07412	Brusni papir 50mm A60	50	•	60	/	/	DPV300, PV301D	25/1	
	E-07428	Brusni papir 50mm A80	50	•	80	/	/	DPV300, PV301D	25/1	
	E-07434	Brusni papir 50mm A120	50	•	120	/	/	DPV300, PV301D	25/1	
	E-07440	Brusni papir 50mm Z60	50	•	60	/	/	DPV300, PV301D	25/1	
	E-07456	Brusni papir 50mm Z80	50	•	80	/	/	DPV300, PV301D	25/1	
	E-07462	Polirna plošča 50mm grobo trda	50	•	/	groba	trda	DPV300, PV301D	25/1	
	E-07478	Polirna plošča 50mm srednje trda	50	•	/	srednje groba	trda	DPV300, PV301D	25/1	
	E-07484	Polirna plošča 50mm fino trda	50	•	/	fina	trda	DPV300, PV301D	25/1	
	E-07490	Polirna plošča 50mm srednje mehka	50	•	/	srednje groba	Mehka	DPV300, PV301D	25/1	
	E-07509	Polirna plošča 50mm fino mehka	50	•	/	fina	Mehka	DPV300, PV301D	25/1	
	E-07515	Polirna plošča 50mm zelo mehka	50	•	/	zelo fina	Mehka	DPV300, PV301D	25/1	

## Akumulatorski robotski sesalnik



### Pribor

Koda	Naziv	Za model	Enota (kos/set)	Cena z DDV	
191P18-9	Alu trak za senzor	DRC300	1		
191P20-2	Mehka krtača	DRC300	1		
191P22-8	Krtača	DRC300	1		
191X35-7	Stranska zaščita	DRC300	1		
SH00000063	Krtača	DRC200	1		
SH00000065	Stranski krtači	DRC200	2/1		
SH00000213	Filter	DRC200	1		
SH00000231	Alu trak za senzor, 15m	DRC200	1		
SH00000314	Zaščita krtače	DRC200	1		

Akumulatorji in polnilniki

Pribor za akumulatorsko orodje

Akumulatorske svetilke in pribor

Pribor za laserske merilnike

Pribor za rušenje in vrtanje

Pribor za vrtanje

Kronske žage

Pribor za vijachenje

Pribor za rezanje in brušenje

Pribor za poliranje in brušenje

Pribor za rezkanje in oblanje

Pribor za multitfunkcijsko orodje

Pribor za žaganje

Pribor za žebjalnike in spenjalnike

Pribor za fene

Pribor za sesanje

Pribor orodja za uporabo na prostem

Pribor za ročno orodje in zaščitna oprema

Kovčki in torbe za orodje

Ročno orodje



Razno

Pribor za mešanje

## Akumulatorska samokolnica







## Pribor

	Koda	Naziv	Mere (D x Š x V) (mm)	Volumen (l)	Opis	Za model	Cena z DDV
	191A01-6	Nastavek s pomožnim kolesom	150 x 530 x 180	/	Pomožna kolesa zmanjšujejo nagibanje samokolnice DCU180 ob nakladanju in razkladanju.	DCU180	
	199008-0	Vedro za samokolnico	/	90	Priročna za pesek, kamne, prah ipd.	DCU180	
	199009-8	Ravna mrežasta podloga za akumulatorsko samokolnico	1.110 - 1.350 x 820 - 1.010 x 820 - 900	/	Priročna za dolg in velik tovor zahvaljujoč odstranljivim stranskim cevm	DCU180	

## Akumulatorski hladilno grelni zaboji



## Pribor

	Koda	Naziv	Celotna dolžina (m)	Model	Cena z DDV
	A-71093	Ramenski pas	/	DCW180, CW001G	
	WL00000002	Napajalni kabel 12-24V za DCW180	2,5	DCW180, CW001G	
	WL00000058	Napajalnik 230V za DCW180	2	DCW180	
	WL00000122	Napajalnik 230V za CW001G	2	CW001G	



# Pribor za akumulatorsko orodje

## Akumulatorski grelniki vode



### Pribor

Koda	Naziv	Za model	Cena z DDV
KF00000076	Zgornji pokrov	KT001G, DKT360	
KF00000085	Kotliček	KT001G, DKT360	



## Akumulatorski kavni aparat



### Pribor

Koda	Naziv	Za model	Cena z DDV
KF00000012	Vložek za kavo	DCM501	
KF00000014	Spodnji vložek za kavo	DCM501	
KF00000020	Nerjaveča skodelica za kavo	DCM501	
KF00000066	Filter za kavo	DCM501	



Nadaljevanje...

- Akumulatorji in polnilniki
- Pribor za akumulatorsko orodje
- Akumulatorske svetilke in pribor
- Pribor za laserske merilnike
- Pribor za rušenje in vrtanje
- Pribor za vrtanje
- Kronske žage
- Pribor za vijachenje
- Pribor za rezanje in brušenje
- Pribor za poliranje in brušenje
- Pribor za rezkanje in oblanje
- Pribor za multitfunkcijsko orodje
- Pribor za žaganje
- Pribor za žebjalnike in spenjalnike
- Pribor za fene
- Pribor za sesanje
- Pribor orodja za uporabo na prostem
- Pribor za čiščenje in zaščitna oprema
- Kovčki in torbe za orodje
- Ročno orodje
- Razno
- Pribor za mešanje

# Pribor za akumulatorsko orodje

	Koda	Naziv	Za model	Cena z DDV
	KF00000069	Pokrov skodelice	DCM501	







- Akumulatorji in polnilniki
- Pribor za akumulatorsko orodje
- Akumulatorske svetilke in pribor
- Pribor za laserske merilnike
- Pribor za rušenje in vrтанje
- Pribor za vrтанje
- Kronske žage
- Pribor za vijačenje
- Pribor za rezanje in brušenje
- Pribor za poliranje in brušenje
- Pribor za rezanje in oblanje
- Pribor za multifunkcijsko orodje
- Pribor za žaganje
- Pribor za žebjalnike in spenjalnike
- Pribor za fene
- Pribor za sesanje
- Pribor za uporabo na prostem
- Pribor za nosenje in zaščita oprema
- Kovčki in torbe za orodje
- Ročno orodje
- Razno
- Pribor za mešanje

# PREBIJALNIKI IN PRIPADAJOČE PODLOGE

## Akumulatorski prebijalniki za kovine: DPP200

V spodnji tabeli preverite optimalno kombinacijo prebijalnika in podloge glede na material.

Za prebijanje okroglih lukenj						
 Prebijalnik		 Podloga		Material		
				Natezna trdnost	Kotni profili/ kanali	Natezna trdnost
Diameter (mm)	Koda	Diameter (mm)	Koda	Mehko jeklo (65.000 psi)		Debelina
6	SC05340040	6	SC00000203	t2-t4	-	
6,5	SC05340050	6,5	SC00000205	t2-t6	-	t3-t4
8	SC05340060	8	SC00000207	t2-t6	-	t3-t4
8,5	SC05340070	8,5	SC00000209	t2-t6	-	t3-t4
10	SC05340080	10	SC00000211	t2-t6	t7,5	t3-t4
11	SC05340090	11	SC00000213	t2-t8	t7,5	t3-t6
12	SC05340100	12	SC00000215	t2-t8	t7,5	t3-t6
13	SC05340110	13	SC00000217	t2-t8	t7,5	t3-t6
14	SC05340120	14	SC00000219	t2-t8	t7,5	t3-t6
15	SC05340130	15	SC00000221	t2-t8	t7,5	t3-t6
16	SC05340140	16	SC05332710	t2-t8	t7,5	t3-t6
18	SC05340150	18	SC00000223	t2-t8	t7,5	t3-t6
19	SC05340170	19	SC05332740	t2-t8	t7,5	t3-t6
20	SC05340160	20	SC05352510	t2-t8	t7,5	t3-t6

Za prebijanje ovalnih lukenj						
 Prebijalnik		 Podloga		Material		
				Natezna trdnost	Kotni profili/ kanali	Natezna trdnost
Diameter (mm)	Koda	Diameter (mm)	Koda	Mehko jeklo (65.000 psi)		Debelina
6,5 × 10	SC05340200	6,5 × 10	SC00000244	t2-t6	-	
6,5 × 13	SC05340210	6,5 × 13	SC00000246	t2-t6	-	t3-t4
8,5 × 13	SC05340220	8,5 × 13	SC00000248	t2-t6	-	t3-t4
8,5 × 17	SC05340230	8,5 × 17	SC00000250	t2-t6	-	t3-t4
9 × 13,5	SC05340240	9 × 13,5	SC00000252	t2-t6	-	t3-t4
9 × 18	SC05340250	9 × 18	SC00000254	t2-t6	-	t3-t4
10 × 15	SC05340260	10 × 15	SC00000256	t2-t8	t7,5	t3-t6
10 × 20	SC05340270	10 × 20	SC00000258	t2-t8	t7,5	t3-t6
11 × 16,5	SC05340280	11 × 16,5	SC00000260	t2-t8	t7,5	t3-t6
12 × 18	SC05340290	12 × 18	SC00000262	t2-t8	t7,5	t3-t6
13 × 19,5	SC05340300	13 × 19,5	SC00000264	t2-t8	t7,5	t3-t6
14 × 21	SC05340310	14 × 21	SC00000266	t2-t8	t7,5	t3-t6

**Delovno stojalo**  
SC03801080



**Drсни omejljik**  
SC03300790



**Hidravlično olje**  
SC00000106







# AKUMULATORSKE SVETILKE IN PRIBOR





# Akumulatorske svetilke in reflektorji

	DML813	DML814	DEADML810	DEAML003G	DEADML809
					
	LED	LED	LED	LED	 LED
<b>Napetost akumulatorja</b>	18V 	18V 	18V  	40V max 	18V 
<b>Čas delovanja</b>	<b>10 / 5,5 / 3 h</b> z BL1850B (1./2./3. stopnja)	<b>10 / 5,5 / 3 h</b> z BL1850B (1./2./3. stopnja)	<b>15 / 7 / 3,5 h</b> z BL1850Bx2 (1./2./3. stopnja)	<b>22 / 10 h</b> z BL4040 (1./2. stopnja)	<b>7,5 / 3,5 / 1,4 h</b> z BL1850Bx2 (1./2./3. stopnja)
<b>Osvetljenost</b>	<b>400 / 750 / 1.250 lx</b> (1./2./3. stopnja) 1 m od izvora	<b>400 / 750 / 1.250 lx</b> (1./2./3. stopnja) 1 m od izvora	<b>150 / 300 / 550 lx</b> (1./2./3. stopnja) 1 m od izvora	<b>200 / 500 lx</b> (1./2. stopnja) 1 m od izvora	<b>800 / 1.500 / 3.800 lx</b> (1./2./3. stopnja) 1 m od izvora
<b>Svetlobni tok (lm = lumni)</b>	<b>900 / 1.700 / 3.000 lm</b> (1./2./3. stopnja)	<b>900 / 1.700 / 3.000 lm</b> (1./2./3. stopnja)	<b>1.500 / 3.000 / 5.500 lm</b> (1./2./3. stopnja)	<b>450 / 1.100 lm</b> (1./2. stopnja)	<b>2.000 / 4.000 / 10.000 lm</b> (1./2./3. stopnja)
<b>Teža</b>	<b>7,9 kg</b>	<b>8,1 kg</b>	<b>15,3 kg</b>	<b>4,7 kg</b>	<b>7,0 kg</b>

	DEADML811	DEADML805	DEBDML812	ML001G	DEADML808
					
	 LED	 LED	LED	LED	LED / funkcija zoženja snopa
<b>Napetost akumulatorja</b>	18V 	18V 	18V 	40V max 	18V 
<b>Čas delovanja</b>	<b>11 / 5,5 / 2,7 h</b> z BL1850B (1./2./3. stopnja)	<b>17 / 8,5 h</b> z BL1850B (1./2. stopnja)	<b>8,5 / 6,5 / 5 / 7 h</b> z BL1850B točkovno / razpršeno / točkovno + razpršeno / utripanje	<b>55 h</b> z BL4040	<b>26 h</b> z BL1850B
<b>Osvetljenost</b>	<b>350 / 800 / 1.800 lx</b> (1./2./3. stopnja) 1 m od izvora	<b>200 / 300 lx</b> (1./2. stopnja) 1 m od izvora	<b>71.000 / 520 lx</b> točkovno / razpršeno 0,5 m od izvora	<b>3.000 lx</b> 1 m od izvora	<b>170 - 4.500 lx</b> 1 m od izvora
<b>Svetlobni tok (lm = lumni)</b>	<b>750 / 1.500 / 3.000 lm</b> (1./2./3. stopnja)	<b>450 / 750 lm</b> (1./2. stopnja)	<b>600 / 1.000 / 1.250 lm</b> točkovno / razpršeno / točkovno + razpršeno	<b>160 lm</b>	<b>190 lm</b>
<b>Teža</b>	<b>4,8 kg</b>	<b>2,7 kg</b>	<b>1,6 kg</b>	<b>1,3 kg</b>	<b>1,09 kg</b>

	DEBDML815	DEAML106	ML002G	DEBDML806	DEAML104
					
	Xenon žarnica	LED / funkcija zoženja snopa	  LED	LED	  LED
<b>Napetost akumulatorja</b>	18V 	12V max 	40V max 	18V 	12V max 
<b>Čas delovanja</b>	<b>45 h</b> z BL1850B	<b>do 12 h</b> z BL1041B	<b>51 / 29 / 16 h</b> z BL4040 baterija / 180° / 360° svetilka	<b>59 / 21 / 11 h</b> z BL1850B baterija / 180° / 360° svetilka	<b>do 19 / 17 h</b> baterija / 90° svetilka z BL1041B
<b>Osvetljenost</b>	<b>3.000 lx</b> 1 m od izvora	<b>170 - 4.500 lx</b> 1 m od izvora	<b>1.900 / 310 / 340 lx</b> baterija na vrhu / 180° / 360° svetilka 0,5 m od izvora	<b>2.100 / 280 / 310 lx</b> baterija na vrhu / 180° / 360° svetilka 0,5 m od izvora	<b>1.900 / 190 / 340 lx</b> baterija na vrhu / 90° / 360° svetilka 0,5 m od izvora
<b>Svetlobni tok (lm = lumni)</b>	<b>160 lm</b>	<b>190 lm</b>	<b>130 / 340 / 710 lm</b> baterija na vrhu / 180° / 360° svetilka	<b>90 / 310 / 620 lm</b> baterija na vrhu / 180° / 360° svetilka	<b>130 / 190 / 710 lm</b> baterija na vrhu / 90° / 360° svetilka
<b>Teža</b>	<b>0,93 kg</b>	<b>0,78 kg</b>	<b>1,5 kg</b>	<b>1,0 kg</b>	<b>0,78 kg</b>

## Akumulatorske svetilke in reflektorji

ML006GX



LED / z difuzorjem

DML816X

**USB** **XPT**  
LED / z difuzorjem

DEADML801



LED

DEADML801X



LED / z difuzorjem

DEADML800



LED

<b>Napetost akumulatorja</b>	40V max <b>XGT</b>	40V max <b>XGT</b>	18V <b>LXT</b>	18V <b>LXT</b>	18V <b>LXT</b>
<b>Čas delovanja</b>	<b>82 / 40 / 20 h</b> z BL4040 (1./2./3. stopnja)	<b>75 / 34 / 17 h</b> z BL1860B (1./2./3. stopnja)	<b>40 / 17 h</b> z BL1850B (1./2. stopnja)	<b>40 / 17 h</b> z BL1850B (1./2. stopnja)	<b>36 h</b> z BL1850B
<b>Osvetljenost</b>	<b>180 / 400 / 800 lx</b> 0,5 m od izvora	<b>180 / 400 / 800 lx</b> 0,5 m od izvora	<b>200 / 400 lx</b> (1./2. stopnja) 0,5 m od izvora	<b>200 / 400 lx</b> (1./2. stopnja) 0,5 m od izvora	<b>2.000 lx</b> 1 m od izvora
<b>Svetlobni tok</b> (lm = lumni)	<b>100 / 250 / 500 lm</b>	<b>100 / 250 / 500 lm</b>	<b>120 / 240 lm</b> (1./2. stopnja)	<b>120 / 240 lm</b> (1./2. stopnja)	<b>100 lm</b>
<b>Teža</b>	<b>1,7 kg</b>	<b>1,1 kg</b>	<b>0,98 kg</b>	<b>0,98 kg</b>	<b>0,91 kg</b>

DEAML103



LED

DEAML102



LED

<b>Napetost akumulatorja</b>	12V max <b>CXT</b>	7,2V / 10,8V
<b>Čas delovanja</b>	<b>do 28 h</b> z BL1041B	<b>do 8 h</b> z BL1013
<b>Osvetljenost</b>	<b>240 / 50 lx</b> 0,5 / 1 m od izvora	<b>120 / 80 lx</b> baterija na vrhu / 360° svetilka 0,5 / 0,4 m od izvora
<b>Svetlobni tok</b> (lm = lumni)	<b>100 lm</b>	<b>100 lm</b>
<b>Teža</b>	<b>0,43 kg</b>	<b>0,4 kg</b>



USB priključek za polnjenje mobilnega telefona



izboljšana zaščita pred prahom in vodo



napajanje z akumulatorji ali AC napajalnim kablom





## Pribor za svetilke

### Žarnice

Koda	Naziv	Napetost (V)	Za model	Enota (kos/set)	Cena z DDV	
192242-1	Žarnica	7,2	ML702	2/1		
192545-3	Žarnica	9,6	ML902, ML903	2/1		
A-30542	Žarnica	18	ML180, DML185	2/1		
A-30673	Žarnica	9,6-12	ML121	2/1		
A-83973	Žarnica	9,6-14,4	ML120, ML124, ML140, ML141, DML145	2/1		
A-87367	Fluorescentna cevna svetilka	9,6-14,4	ML122, ML142	1		
A-87373	Žarnica	24	DML240	2/1		
B-07303	Žarnica	14,4-18	DML184	2/1		
GM00001161	Fluorescentna cevna svetilka	14,4-18	DML184	1		

### Pribor razno

Koda	Naziv	Za model	Višina (mm)	Cena z DDV	
A-58154	Difuzor	DML805	/		
GM00001028	Obešalni kavelj	ML04, ML002, ML001G, ML002G	/		

[Nadaljevanje...](#)

Akumulat  
orji in  
pomilniki

Pribor za  
akumulat  
orsko  
orodje

Akumulat  
orske  
svetilke  
in pribor

Pribor za  
lasarske  
merilnike

Pribor za  
rušenje  
in vrtanje

Pribor za  
vrtanje

Kronske  
žage

Pribor za  
vijačenje

Pribor za  
rezanje  
in  
brušenje

Pribor za  
poliranje  
in  
brušenje

Pribor za  
rezkanje  
in  
oblanje

Pribor za  
multifunk  
cijsko  
orodje

Pribor za  
žaganje

Pribor za  
žebjalnike  
in  
spenjalnike

Pribor za  
fene

Pribor za  
sesanje

Pribor  
orodja za  
uporabo  
na prostem

Pribor za  
ploščne  
orodje in  
zaščitna  
oprema







Kovčki in  
torbe za  
orodje

Ročno  
orodje

Razno

Pribor za  
mešanje

## Akumulatorske svetilke in pribor

	Koda	Naziv	Za model	Višina (mm)	Cena z DDV
	GM00001157	Gibljive roke za 10,8 V svetilko	ML101	/	
	GM00001326	Difuzor	DML816, ML001G	/	
	GM00001396	Spona DML805	DML805	/	
	GM00001683	Magnetni priključek za ML104	ML104, ML105, ML106	/	
	GM00002073	Kovinsko stojalo za svetilko DML809	DML809, DML811	1.300 - 2.000	
	GM00002283	Kovinsko stojalo za svetilko DML805	DML805	992 - 1.750	
	GM00002286	Difuzor za DML809	DML809	/	
	GM00002287	Difuzor za DML811	DML811	/	
	GM00002312	Difuzor za ML003G	ML003G	/	
	TD00000001	Transportna torba	DML813, DML814	/	
	TD00000002	Ramenski pas za torbo	TD00000001	/	







# PRIBOR ZA LASERSKE MERILNIKE









## Stojala za laserje in ostali pribor

## Stojala

	Koda	Naziv	Velikost navoja	Višina (mm)	Cena z DDV
	P-81088	Standardno aluminijasto trinožno stojalo	5/8"	440 - 1.650	
	P-81315	Teleskopsko nastavljivo AlU trinožno stojalo	5/8"	1.000 - 2.700	
	TK0LM2000F	Aluminijasto trinožno stojalo-malo	5/8"	400 - 1.100	
	TK0LM4001F	Aluminijasto trinožno stojalo	5/8"	680 - 1.800	
	TK0LM5030F	Aluminijasto trinožno stojalo	5/8"	780 - 2.900	

## Ostali pribor

	Koda	Naziv	Za model	Cena z DDV
	199010-3	USB kabel	SK312GD, SK209GD	
	199011-1	Zapestni trak	SK312GD, SK209GD	
	199178-5	USB kabel	SK105, SK106	
	832173-9	Torba za laserje	SK105D, SK105GD, SK106D, SK106GD, SK700D, SK700GD	
	CP00000001	Adapter za CXT laserje (8x AA baterije)	SK10GD, SK20GD, SK209GD, SK312GD, SK40GD, SK700D, SK700GD	
	LE00758831	Ciljna ploščica	SK105, SK106, SK700D	

[Nadaljevanje...](#)

# Pribor za laserske merilnike

Koda	Naziv	Za model	Cena z DDV	
LE00785519	Kroglični adapter 1/4"	SK102Z, SK103PZ, SK104Z		
LE00785633	Magnetno držalo z adapterjem 5/8"-1/4"	SK102Z, SK103PZ, SK104Z		
LE00785637	Stensko vodilo 1/4"	SK102Z, SK103PZ, SK104Z		
LE00785640	Detektor laserskega žarka	SK102Z, SK103PZ, SK104Z		
LE00796587	Sprejemnik LR150 za laserski merilnik	SKR200Z		
LE00796588	Daljinec RC30	SKR200Z		
LE00823195	Ciljna ploščica	SK105GD, SK106GD, SK209GD, SK312GD, SK700GD		
LE00855702	Detektor laserskega žarka	SK103, SK104, SK105, SK106, SK700D, SK700GD		
LE00870137	Stenski nosilec za laser	SK103, SK104, SK105, SK106, SK700D, SK700GD		
P-81309	Aluminijasta merilna palica	SKR200Z, SKR102Z		
TK000ET03F	Stenski nosilec	SK312GD, SK209GD		
TK0LDG301G	Sprejemnik LDG-3 za laserski merilnik	SK312GD, SK209GD		
TK0LDG501G	Sprejemnik LDG-5 za laserski merilnik	SK10GD, SK20GD, SK40GD, SK209GD, SK312GD		
TK0LEG2000	Očala za boljši pogled na lasersko linijo	LD050P, LD080P, LD100P, SK102Z, SKR200Z, 103PZ, SK104Z		

Akumulat  
orj in  
poinliniki

Pribor za  
akumulat  
orsko  
orodje

Akumulat  
orske  
svetilke  
in pribor

Pribor za  
laserske  
merilnike

Pribor za  
rušenje  
in vrtanje

Pribor za  
vrtanje

Kronske  
žage

Pribor za  
vijačenje

Pribor za  
rezanje  
in  
brušenje

Pribor za  
poliranje  
in  
brušenje

Pribor za  
rezkanje  
in  
oblanje

Pribor za  
multifunk  
ciljsko  
orodje

Pribor za  
žaganje

Pribor za  
žebjalnike  
in  
spenjalnike

Pribor za  
fene

Pribor za  
sesanje

Pribor  
orodja za  
uporabo  
na prostem

Pribor za  
prosta  
orodja in  
zaščitna  
oprema

Kovčki in  
torbe za  
orodje

Ročno  
orodje

Razno

Pribor za  
mešanje



# PRIBOR ZA RUŠENJE IN VRTANJE

SDS-PLUS



SDS-MAX



Cilindrično vpetje



GKW vpetje



13 mm šestrobno vpetje



17 mm šestrobno vpetje



19 mm šestrobno vpetje



21 mm šestrobno vpetje



28,6 mm šestrobno vpetje



30 mm šestrobno vpetje



1/4" šestrobno vpetje



Armiran beton



Beton



Granit



Opeka



Apnenec



Asfalt



Keramične ploščice



Les



Kovine



Led



Za suho vrtanje



Odsesovanje prahu















Malta

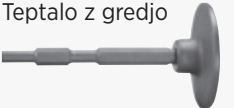





OBLIKA:	UPORABA:	SDS-Plus	SDS-Max	17 mm Hex	19 mm Hex	21 mm Hex	28,6 mm Hex	30 mm Hex
<p>Samoostrilna špica</p> 	Rušenje, prilagoditvena dela ter dletenje v kamen ali beton.		•				•	•
<p>Špica</p> 	Rušenje, prilagoditvena dela ter dletenje v kamen ali beton.	•	•	•	•	•	•	•
<p>Ploščato dleto</p> 	Prilagoditvena dela, dletenje, rušenje, obdelava robov ter izdelava kanalov v zid, kamen ali beton.	•	•	•	•	•	•	•
<p>Kanalno dleto</p> 	Izdelava kanalov v beton.	•	•		•			
<p>Široko dleto</p> 	Odstranjevanje ostankov betona.	•	•	•	•	•	•	•
<p>Lopatasto dleto</p> 	Kopanje v glino, trdo zemljo ali trd zbit gramož.		•	•				•
<p>Teptalo z gredjo</p> 	Teptanje asfalta ali stiskanje gramoža in zemlje.			•				•
<p>Plošča za rebričenje</p> 	Za rebričenje betona in asfalta.		•					
<p>Strgalo</p> 	Odstranjevanje lepil in čiščenje podlage.	•						
<p>Kanalno dleto s krili</p> 	Za obdelavo opeke in apnenca. Idealno za spremenljivo globino kanala s pomočjo krilc.	•	•					
<p>Dleto za odstranjevanje ploščic</p> 	Za odstranjevanje ploščic.	•	•					
<p>Dleto za fuge</p> 	Za odstranjevanje ometnih plasti ter fug med zidaki in ploščicami.		•					
<p>Dleto za obdelavo lesa</p> 	Specialno dleto za obdelavo lesa.	•						



## SDS-Plus PRIMERJAVA SVEDROV

SVEDER	STANDARD	S CENTRIRNO KONICO	STANDARD 4	V-PLUS	NEMESIS II
Kakovostni razred	★★	★★★	★★★	★★★★	★★★★★
Karbidna konica					
Konica	2-rezna konica	2-rezna centrirna konica	4-rezna centrirna konica	Nazobčana 2-rezna centrirna konica	Simetrična 4-rezna centrirna konica
Spirala	Dvojna spirala	Dvojna spirala	Dvojna spirala	Vzdržljiva dvojna spirala	Vzdržljiva štirikratna spirala
Premer (ø)	3,5-30 mm	4-32 mm	5-25 mm	5-26 mm	5-32 mm
Hitrost					
Življenjska doba					
Enostavno določanje položaja					
Natančnost					
Odvajanje odrezkov v Armiranem betonu					
Material					



## SDS-Max PRIMERJAVA SVEDROV

SVEDER	STANDARD	MAK4	RUDARSKI
Kakovostni razred	★★	★★★★	SPECIALIZED
Karbidna konica			
Konica	2-rezna konica	4-rezna centrirna konica	4-rezna konica
Spirala	Dvojna spirala	Vzdržljiva štirikratna spirala	Vzdržljiva dvojna spirala
Premer (ø)	12-40 mm	12-52 mm	28-32 mm
Hitrost			SPECIALIZED
Življenjska doba			
Enostavno določanje položaja			
Natančnost			
Odvajanje odrezkov v Armiranem betonu			
Material			

Opeka



Beton



Armiran beton



Granit



# NEMESIS II



## SDS-Plus SVEDRI NEMESIS II



Ojačitve

Stranske ojačitve svedra zagotavljajo varno uporabo in veliko torzijsko trdnost.

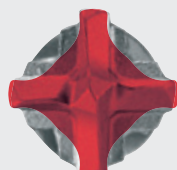

Simetrične spirale

4 simetrične spirale za enakomerno odvajanje odrezanega materiala.



Oblika utorov

Izboljšana oblika utorov zagotavlja hitro odvajanje odrezanega materiala.



Posneti robovi

Povečano posnetje robov zmanjša nevarnost zatikanja.



5-16 mm Ø

Trdna centriralna konica omogoča vrtnje točno na označenih mestih.



18-32 mm Ø

Trodalna karbidna konica svedru omogoča enostavno vrtnje skozi železne ojačitve v betonu.

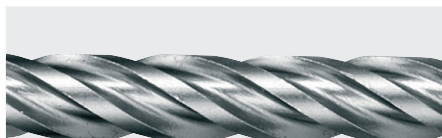

Toga spirala

Toga spirala znižuje vibracije in zagotavlja visoko odpornost proti zlomu.



Indikator izrabljenosti

Indikator izrabljenosti svedra.

# 150%

Življenska doba

Daljša življenska doba od standardnih svedrov.



## SDS-Plus DVOREZNI SVEDRI V-PLUS

Stožčasta geometrija spirale omogoča večjo vrtno hitrost in izjemno vzdržljivost.

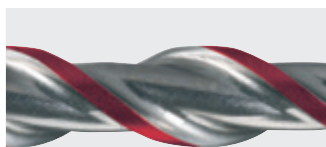

Stožčasta spirala

Oblika spirale omogoča manj trenja in dobro odstranjevanje odrezkov za hitrejše vrtnje.



Nazobčani rezalni robovi

Robovi pri vrtnju ustvarjajo mikro razpoke v obdelovancu za večjo vrtno hitrost.



Izboljšana centriralna konica

Konica omogoča natančno vrtnje in preprečuje zdrse na gladkih površinah.



Posneti robovi

Večja posnetja robov zmanjšajo nevarnost zataknitve svedra v betonu z železnimi ojačitvami.

# INOVATIVEN SISTEM ODSESOVANJA

Nova serija svedrov za odsesovanje



Združljivi s cevjo  
Ø28 mm

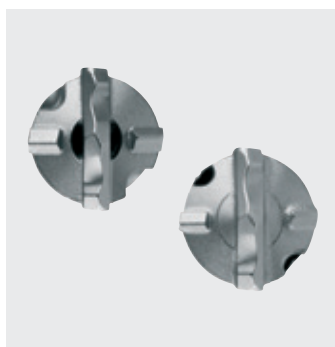

#### 3-DELNA KONICA

Trodalna konica svedru omogoča enostavno vrtanje skozi železne ojačitve v betonu.



#### SVEDER - SESALNIK

Kompatibilen z večino sesalnikov s sistemom za odsesovanje.



#### VSESTRANSKOST

Svedri s priključkom za odsesovanje na voljo z SDS-Plus in SDS-Max vpetjem.



Za varno delo pridržite priključeno cev z roko ali jo naslonite na nogo za preprečitev hkratnega vrtenja s svedrom.

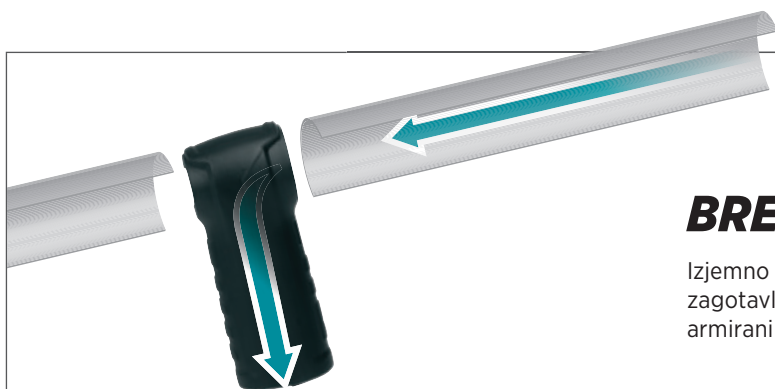

## BREZ-PRAŠNO VRTANJE

Izjemno učinkovito odsesovanje prahu s konice svedra zagotavlja čisto delovno območje. Primerni za beton in armirani beton.

### SDS-MAX

Model	Premer	Dolžina	Delovna dolžina	Model	Premer	Dolžina	Delovna dolžina
B-64428	16 mm	600 mm	400 mm	B-64490	28 mm	900 mm	700 mm
B-64434	18 mm	600 mm	400 mm	B-64509	30 mm	600 mm	400 mm
B-64440	20 mm	600 mm	400 mm	B-64515	30 mm	900 mm	700 mm
B-64456	22 mm	600 mm	400 mm	B-64537	32 mm	900 mm	700 mm
B-64462	24 mm	600 mm	400 mm	B-64521	32 mm	600 mm	400 mm
B-64478	25 mm	600 mm	400 mm	B-64543	35 mm	600 mm	400 mm
B-64484	28 mm	600 mm	400 mm	B-64559	35 mm	900 mm	700 mm

### SDS-PLUS

Model	Premer	Dolžina	Delovna dolžina
B-64381	12 mm	200 mm	325 mm
B-64397	14 mm	240 mm	360 mm
B-64406	16 mm	240 mm	360 mm
B-64412	18 mm	240 mm	360 mm

# Pribor za rušenje in vrtanje

## Pribor za vrtalna in rušilna kladiva s SDS-Plus vpetjem

### Svedri SDS-Plus Nemesis II

★★★★★

Vrtanje v armirani beton ni več delo na slepo, saj ojačitvena palica ne predstavlja nobene ovire za sveder Nemesis II. Nemesis II sveder je odličen tudi za vrtanje v najtrši naravni kamen. Edinstvena simetrična oblika konice svedra zagotavlja natančno vrtanje lukenj, poleg tega pa je sveder Nemesis II odličen za vrtanje lukenj za sidra, kjer je potrebna velika natančnost. Z Nemesis II svedrom boste izvrtali občutno več lukenj kot z običajnimi svedri.

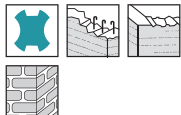

Koda	Premer	Celotna dolžina	Delovna dolžina
B-57897	5 mm	115 mm	50 mm
B-57906	5 mm	165 mm	100 mm
B-57940	5,5 mm	115 mm	50 mm
B-57962	6 mm	115 mm	50 mm
B-57978	6 mm	165 mm	100 mm
B-57984	6 mm	215 mm	150 mm
B-57990	6 mm	265 mm	200 mm
B-58001	6 mm	315 mm	250 mm
B-58023	6,5 mm	165 mm	100 mm
B-58039	6,5 mm	215 mm	150 mm
B-58045	6,5 mm	265 mm	200 mm
B-58051	6,5 mm	315 mm	250 mm
B-58073	7 mm	165 mm	100 mm
B-58095	8 mm	115 mm	50 mm
B-58104	8 mm	165 mm	100 mm
B-58110	8 mm	215 mm	150 mm
B-58126	8 mm	265 mm	200 mm
B-58132	8 mm	315 mm	250 mm
B-58154	8 mm	465 mm	400 mm
B-58176	9 mm	165 mm	100 mm
B-58198	10 mm	115 mm	50 mm
B-58207	10 mm	165 mm	100 mm
B-58213	10 mm	215 mm	150 mm
B-58229	10 mm	265 mm	200 mm
B-58235	10 mm	315 mm	250 mm
B-58257	10 mm	455 mm	390 mm
B-58263	10 mm	600 mm	540 mm
B-58279	10 mm	1.000 mm	940 mm
E-14495	11 mm	165 mm	110 mm
E-14504	11 mm	215 mm	160 mm
E-14510	11 mm	265 mm	210 mm
E-14526	11 mm	315 mm	260 mm
E-14532	12 mm	165 mm	110 mm
E-14548	12 mm	215 mm	160 mm
E-14554	12 mm	265 mm	210 mm
E-14560	12 mm	315 mm	260 mm
E-14576	12 mm	455 mm	400 mm
E-14582	12 mm	600 mm	550 mm
E-14598	13 mm	165 mm	110 mm
E-14607	13 mm	215 mm	160 mm
E-14613	13 mm	265 mm	210 mm
E-14629	13 mm	315 mm	260 mm
E-14635	14 mm	165 mm	110 mm
E-14641	14 mm	215 mm	160 mm
E-14657	14 mm	265 mm	210 mm
E-14663	14 mm	315 mm	260 mm
E-14679	14 mm	455 mm	400 mm

E-14685	14 mm	600 mm	550 mm
E-14691	15 mm	165 mm	110 mm
E-14700	15 mm	215 mm	160 mm
E-14716	15 mm	265 mm	210 mm
E-14722	15 mm	155 mm	100 mm
E-14738	16 mm	165 mm	110 mm
E-14744	16 mm	215 mm	160 mm
E-14750	16 mm	265 mm	210 mm
E-14766	16 mm	315 mm	260 mm
E-14772	16 mm	455 mm	400 mm
E-14788	16 mm	600 mm	550 mm
B-58615	18 mm	250 mm	200 mm
B-58621	18 mm	450 mm	400 mm
B-58637	20 mm	250 mm	200 mm
B-58659	20 mm	450 mm	400 mm
B-58665	22 mm	250 mm	200 mm
B-58687	22 mm	450 mm	400 mm
B-58693	24 mm	250 mm	200 mm
B-58702	24 mm	450 mm	400 mm
B-58718	25 mm	250 mm	200 mm
B-58724	25 mm	450 mm	400 mm
B-58746	28 mm	250 mm	200 mm
B-58752	28 mm	450 mm	400 mm
B-58768	30 mm	250 mm	200 mm
B-58774	30 mm	450 mm	400 mm
B-58780	32 mm	450 mm	400 mm

### Seti svedrov SDS-Plus Nemesis II

★★★★★

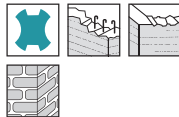

Koda	Premer	Celotna dolžina	Enota (kos/set)
E-14794	12 mm	165 mm	5
E-14803	12 mm	215 mm	5
E-14819	12 mm	265 mm	5
E-14825	12 mm	165 mm	10
E-14831	12 mm	215 mm	10
E-14847	12 mm	265 mm	10
E-14853	12 mm	310 mm	10
E-14869	14 mm	165 mm	10
E-14875	14 mm	215 mm	10
E-14881	14 mm	265 mm	10
E-14897	14 mm	315 mm	10

### Svedri SDS-Plus V-Plus

★★★★

V-Plus svedri postavljajo nove standarde zmogljivosti. Stožčasta geometrija spirale omogoča večjo vrtalno hitrost in izjemno vzdržljivost. So odlični za uporabo z akumulatorskimi vrtalnimi kladivi.

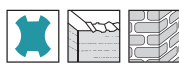

Koda	Premer	Celotna dolžina	Delovna dolžina
B-46492	5 mm	110 mm	50 mm
B-46501	5 mm	160 mm	100 mm
B-47254	5 mm	140 mm	80 mm
B-60408	5 mm	450 mm	390 mm

- Akumulat orji in polnilniki
- Pribor za akumulat orske svetilke in pribor
- Akumulat orske svetilke in pribor
- Pribor za laserske merilnike
- Pribor za rušenje in vrtanje
- Pribor za vrtanje
- Kronске žage
- Pribor za vijachenje
- Pribor za rezanje in brušenje
- Pribor za poliranje in brušenje
- Pribor za rezkanje in oblanje
- Pribor za multifunk cjsko orodje
- Pribor za zaganje
- Pribor za žebjalnike in spenjalnike
- Pribor za fene
- Pribor za sesanje
- Pribor za uporabo na prostem
- Pribor za posebe zasajna optena
- Kovčki in torbe za orodje
- Ročno orodje
- Razno
- Pribor za mešanje



# Pribor za rušenje in vrtanje

Akumulat orji in polnilniki	Pribor za akumulat orsko orodje	Akumulat orske svetilke in pribor	Pribor za laserske merilnike	Pribor za rušenje in vrtanje	Pribor za vrtanje	Kronske žage	Pribor za vijačenje	Pribor za rezanje in brušenje	Pribor za poliranje in brušenje	Pribor za rezkanje in oblanje	Pribor za multifunkcijsko orodje	Pribor za žaganje	Pribor za žabljanke in spenjalnike	Pribor za fene	Pribor za sesanje	Pribor za uporabo na prostem	Pribor za nošenje orodja za zaprtje	Kovčki in torbe za orodje	Ročno orodje	Razno	Pribor za mešanje
B-46517	6 mm	110 mm	50 mm																		
B-46523	6 mm	160 mm	100 mm																		
B-47341	6 mm	210 mm	150 mm																		
B-47357	6 mm	260 mm	200 mm																		
B-47363	6 mm	310 mm	250 mm																		
B-47379	6 mm	460 mm	400 mm																		
B-47391	6,5 mm	160 mm	100 mm																		
B-47400	6,5 mm	210 mm	150 mm																		
B-47416	6,5 mm	260 mm	200 mm																		
B-47422	6,5 mm	310 mm	250 mm																		
B-47438	7 mm	110 mm	50 mm																		
B-47444	7 mm	160 mm	100 mm																		
B-46539	8 mm	110 mm	50 mm																		
B-46545	8 mm	160 mm	100 mm																		
B-47472	8 mm	210 mm	150 mm																		
B-47488	8 mm	260 mm	200 mm																		
B-47503	8 mm	400 mm	340 mm																		
B-47519	8 mm	460 mm	400 mm																		
B-47525	8 mm	600 mm	540 mm																		
B-47531	9 mm	160 mm	100 mm																		
B-47547	9 mm	210 mm	150 mm																		
B-47553	9,5 mm	160 mm	100 mm																		
B-51409	9,5 mm	310 mm	250 mm																		
B-46551	10 mm	110 mm	50 mm																		
B-46567	10 mm	160 mm	100 mm																		
B-47569	10 mm	210 mm	150 mm																		
B-47575	10 mm	260 mm	200 mm																		
B-47581	10 mm	310 mm	250 mm																		
B-47597	10 mm	350 mm	290 mm																		
B-47606	10 mm	450 mm	390 mm																		
B-47612	10 mm	600 mm	540 mm																		
B-47628	10 mm	800 mm	740 mm																		
B-47634	10 mm	1.000 mm	940 mm																		
B-47656	11 mm	210 mm	160 mm																		
B-47662	11 mm	260 mm	210 mm																		
B-46573	12 mm	160 mm	100 mm																		
B-47684	12 mm	210 mm	160 mm																		
B-47690	12 mm	260 mm	210 mm																		
B-47715	12 mm	360 mm	310 mm																		
B-47721	12 mm	450 mm	400 mm																		
B-47737	12 mm	600 mm	550 mm																		
B-47743	12 mm	800 mm	740 mm																		
B-47759	12 mm	1.000 mm	950 mm																		
B-47765	13 mm	160 mm	110 mm																		
B-47771	13 mm	210 mm	160 mm																		
B-47787	13 mm	260 mm	210 mm																		
B-47793	13 mm	310 mm	260 mm																		
B-46589	14 mm	160 mm	110 mm																		
B-47802	14 mm	210 mm	160 mm																		
B-47818	14 mm	260 mm	210 mm																		
B-47830	14 mm	450 mm	400 mm																		
B-47846	14 mm	600 mm	550 mm																		
B-47852	14 mm	1.000 mm	950 mm																		
B-47868	15 mm	160 mm	110 mm																		
B-47874	15 mm	210 mm	160 mm																		
B-47880	15 mm	260 mm	210 mm																		
B-47896	15 mm	450 mm	400 mm																		
B-47905	16 mm	160 mm	110 mm																		
B-47911	16 mm	210 mm	160 mm																		
B-47927	16 mm	260 mm	210 mm																		
B-47933	16 mm	310 mm	260 mm																		
B-47949	16 mm	450 mm	400 mm																		
B-47955	16 mm	600 mm	550 mm																		

B-47961	16 mm	800 mm	750 mm
B-47977	16 mm	1.000 mm	950 mm
B-47983	17 mm	210 mm	160 mm
B-47999	17 mm	450 mm	400 mm
B-48000	18 mm	200 mm	150 mm
B-48016	18 mm	300 mm	250 mm
B-48022	18 mm	450 mm	400 mm
B-48038	18 mm	600 mm	550 mm
B-48044	18 mm	1.000 mm	950 mm
B-48050	19 mm	200 mm	150 mm
B-48066	19 mm	450 mm	400 mm
B-48072	20 mm	200 mm	150 mm
B-48088	20 mm	300 mm	250 mm
B-48094	20 mm	450 mm	400 mm
B-48103	20 mm	600 mm	550 mm
B-48119	20 mm	800 mm	750 mm
B-48125	20 mm	1.000 mm	950 mm
B-48131	22 mm	250 mm	200 mm
B-48147	22 mm	450 mm	400 mm
B-48153	22 mm	600 mm	550 mm
B-48169	22 mm	1.000 mm	950 mm
B-48175	23 mm	250 mm	200 mm
B-48181	23 mm	450 mm	400 mm
B-48197	24 mm	250 mm	200 mm
B-48206	24 mm	450 mm	400 mm
B-48212	24 mm	600 mm	550 mm
B-48234	25 mm	450 mm	400 mm
B-48240	25 mm	600 mm	550 mm
B-48256	25 mm	1.000 mm	950 mm
B-48262	26 mm	250 mm	200 mm
B-48278	26 mm	450 mm	400 mm

## Svedri SDS-Plus s 4-rezno konico

★★★★

Štirirezna konica iz karbidne trdine, preprečuje zagozdenje v jeklene palice. Natančno rezanje lukenj za gladko, enakomerno zaokroženo luknjo. Primerno za armirani beton.

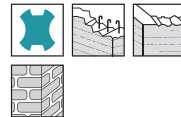

Koda	Premer	Celotna dolžina	Delovna dolžina
B-68127	5 mm	110 mm	50 mm
B-68133	5 mm	160 mm	100 mm
B-68149	5 mm	210 mm	150 mm
B-68155	5 mm	260 mm	200 mm
B-62496	6 mm	110 mm	50 mm
B-62505	6 mm	160 mm	100 mm
B-62511	6 mm	210 mm	150 mm
B-62527	6 mm	260 mm	200 mm
B-68161	6 mm	310 mm	250 mm
B-62533	6,5 mm	110 mm	50 mm
B-62549	6,5 mm	160 mm	100 mm
B-62555	6,5 mm	210 mm	150 mm
B-62561	6,5 mm	260 mm	200 mm
B-62577	7 mm	110 mm	50 mm
B-62583	7 mm	160 mm	100 mm
B-62599	7 mm	210 mm	150 mm
B-62608	8 mm	110 mm	50 mm
B-62614	8 mm	160 mm	100 mm
B-62620	8 mm	210 mm	150 mm
B-62636	8 mm	260 mm	200 mm

# Pribor za rušenje in vrtanje

B-62642	8 mm	310 mm	250 mm
B-62658	8 mm	460 mm	400 mm
B-62664	10 mm	110 mm	50 mm
B-62670	10 mm	160 mm	100 mm
B-62686	10 mm	210 mm	150 mm
B-62692	10 mm	260 mm	200 mm
B-62701	10 mm	310 mm	250 mm
B-62717	10 mm	350 mm	290 mm
B-62723	10 mm	460 mm	400 mm
B-62739	12 mm	160 mm	100 mm
B-62745	12 mm	210 mm	150 mm
B-62751	12 mm	260 mm	200 mm
B-62767	12 mm	310 mm	250 mm
B-62773	12 mm	350 mm	290 mm
B-62789	12 mm	460 mm	400 mm
B-62795	14 mm	160 mm	100 mm
B-62804	14 mm	210 mm	150 mm
B-62810	14 mm	260 mm	200 mm
B-62826	14 mm	310 mm	250 mm
B-62832	14 mm	350 mm	290 mm
B-62848	14 mm	460 mm	400 mm
B-62854	16 mm	160 mm	100 mm
B-62860	16 mm	210 mm	150 mm
B-62876	16 mm	260 mm	200 mm
B-62882	16 mm	310 mm	250 mm
B-62898	16 mm	350 mm	290 mm
B-62907	16 mm	460 mm	400 mm
B-68177	18 mm	260 mm	200 mm
B-68236	18 mm	460 mm	400 mm
B-68183	20 mm	260 mm	200 mm
B-68242	20 mm	460 mm	400 mm
B-68199	22 mm	260 mm	200 mm
B-68258	22 mm	460 mm	400 mm
B-68208	25 mm	260 mm	200 mm
B-68264	25 mm	460 mm	400 mm

B-55968	8 mm	260 mm	200 mm
B-67848	8 mm	310 mm	250 mm
B-67854	8 mm	400 mm	340 mm
B-68046	8 mm	460 mm	400 mm
B-55974	9 mm	160 mm	100 mm
B-67860	9 mm	210 mm	150 mm
B-54190	10 mm	160 mm	100 mm
B-54209	10 mm	210 mm	150 mm
B-55980	10 mm	110 mm	50 mm
B-55996	10 mm	260 mm	200 mm
B-56007	10 mm	310 mm	250 mm
B-56013	10 mm	460 mm	400 mm
B-67876	10 mm	350 mm	290 mm
B-67882	11 mm	160 mm	100 mm
B-67898	11 mm	210 mm	150 mm
B-67907	11 mm	260 mm	200 mm
B-54215	12 mm	160 mm	100 mm
B-54221	12 mm	210 mm	150 mm
B-56029	12 mm	260 mm	200 mm
B-56035	12 mm	350 mm	290 mm
B-56041	12 mm	460 mm	400 mm
B-67913	12 mm	310 mm	250 mm
B-56057	13 mm	160 mm	100 mm
B-67929	13 mm	210 mm	150 mm
B-67935	13 mm	260 mm	200 mm
B-56063	14 mm	160 mm	100 mm
B-56079	14 mm	210 mm	150 mm
B-56085	14 mm	260 mm	200 mm
B-56091	14 mm	350 mm	290 mm
B-56100	14 mm	460 mm	400 mm
B-56116	16 mm	160 mm	100 mm
B-56122	16 mm	210 mm	150 mm
B-56138	16 mm	310 mm	250 mm
B-56144	16 mm	350 mm	290 mm
B-56150	16 mm	460 mm	400 mm
B-56465	17 mm	210 mm	150 mm
B-56471	17 mm	350 mm	290 mm
B-62125	18 mm	210 mm	150 mm
B-62131	18 mm	350 mm	290 mm
B-62147	19 mm	210 mm	150 mm
B-62153	19 mm	350 mm	290 mm
B-62169	20 mm	210 mm	150 mm
B-62175	20 mm	350 mm	290 mm
B-62181	22 mm	210 mm	150 mm
B-62197	22 mm	350 mm	290 mm
B-62206	24 mm	210 mm	150 mm
B-62212	24 mm	350 mm	290 mm
B-62228	25 mm	210 mm	150 mm
B-62234	25 mm	350 mm	290 mm
B-62240	28 mm	210 mm	150 mm
B-62256	28 mm	350 mm	290 mm
B-62262	30 mm	210 mm	150 mm
B-62278	30 mm	350 mm	290 mm
B-62284	32 mm	350 mm	290 mm

## Svedri SDS-Plus s centrino konico ★★★



Koda	Premer	Celotna dolžina	Delovna dolžina
B-55859	4 mm	110 mm	50 mm
B-54128	5 mm	110 mm	50 mm
B-54134	5 mm	160 mm	100 mm
B-55865	5,5 mm	110 mm	50 mm
B-55871	5,5 mm	160 mm	100 mm
B-54140	6 mm	110 mm	50 mm
B-54156	6 mm	160 mm	100 mm
B-54162	6 mm	210 mm	150 mm
B-67832	6 mm	260 mm	200 mm
B-55887	6,5 mm	110 mm	50 mm
B-55893	6,5 mm	160 mm	50 mm
B-55902	6,5 mm	210 mm	150 mm
B-55918	6,5 mm	260 mm	200 mm
B-55924	7 mm	110 mm	50 mm
B-55930	7 mm	160 mm	100 mm
B-55946	7 mm	210 mm	150 mm
B-54178	8 mm	110 mm	50 mm
B-54184	8 mm	160 mm	100 mm
B-55952	8 mm	210 mm	150 mm

- Akumulat orji in polnilniki
- Pribor za akumulat orske orodje
- Akumulat orske svetilke in pribor
- Pribor za laserske merilnike
- Pribor za rušenje in vrtanje
- Pribor za vrtanje
- Kronske žage
- Pribor za vijčenje
- Pribor za rezanje in brušenje
- Pribor za poliranje in brušenje
- Pribor za rezkanje in oblanje
- Pribor za multifunkcijsko orodje
- Pribor za žaganje
- Pribor za žebjalnike in spenjalnike
- Pribor za fene
- Pribor za sesanje
- Pribor za uporabo na prostem
- Pribor za nosenje orodja za zaščitna oprema
- Kovčki in torbe za orodje
- Ročno orodje
- Razno
- Pribor za mešanje

## Svedri SDS-Plus Standard

★★

SDS-Plus svedri z dvorezno konico so primerni za vrtanje v zidane stene in beton. Kvalitetna karbidna konica s centrirno špico in izboljšanimi utori za odvajanje prahu omogočajo visoke vrtnalne hitrosti za cenejša opravila. TCT konica je izdelana v skladu z DIN 8039 in je na voljo v velikostih od 3,5 do 30 mm.



Koda	Premer	Celotna dolžina	Delovna dolžina
D-16950	3,5 mm	90 mm	30 mm
D-00016	4 mm	110 mm	50 mm
D-00022	5 mm	110 mm	50 mm
D-00038	5 mm	160 mm	100 mm
D-00044	5,5 mm	110 mm	50 mm
D-00050	6 mm	110 mm	50 mm
D-00066	6 mm	160 mm	100 mm
D-00072	6 mm	210 mm	150 mm
D-00088	6,5 mm	110 mm	50 mm
D-00094	6,5 mm	160 mm	100 mm
D-45082	6,5 mm	210 mm	150 mm
D-00103	7 mm	110 mm	50 mm
D-00119	7 mm	160 mm	100 mm
D-00125	8 mm	110 mm	50 mm
D-00131	8 mm	160 mm	100 mm
D-00147	8 mm	210 mm	150 mm
D-00153	8 mm	260 mm	200 mm
D-00169	9 mm	210 mm	150 mm
D-08056	9 mm	160 mm	100 mm
D-00175	10 mm	160 mm	100 mm
D-00181	10 mm	210 mm	150 mm
D-00197	10 mm	260 mm	200 mm
D-00206	10 mm	310 mm	250 mm
D-17538	10 mm	460 mm	400 mm
D-00212	11 mm	160 mm	100 mm
D-00228	12 mm	160 mm	100 mm
D-00234	12 mm	210 mm	150 mm
D-00240	12 mm	260 mm	200 mm
D-16271	12 mm	460 mm	400 mm
D-00256	13 mm	160 mm	100 mm
D-00262	14 mm	160 mm	100 mm
D-00278	14 mm	260 mm	200 mm
D-17544	14 mm	460 mm	400 mm
D-00284	15 mm	160 mm	100 mm
D-17550	15 mm	460 mm	400 mm
D-00290	16 mm	210 mm	150 mm
D-00309	16 mm	310 mm	250 mm
D-16287	16 mm	460 mm	400 mm
D-00315	17 mm	210 mm	150 mm
D-00321	18 mm	210 mm	150 mm
D-00337	18 mm	300 mm	240 mm
D-16221	18 mm	350 mm	245 mm
D-17566	18 mm	460 mm	400 mm
D-00343	19 mm	210 mm	150 mm
D-16293	19 mm	460 mm	400 mm
D-00359	20 mm	210 mm	150 mm
D-00365	20 mm	310 mm	250 mm
D-15235	20 mm	460 mm	400 mm
D-00371	22 mm	260 mm	200 mm
D-08062	22 mm	310 mm	250 mm
D-15241	22 mm	460 mm	400 mm
D-16302	24 mm	460 mm	400 mm
D-00387	25 mm	260 mm	200 mm

D-08517	25 mm	310 mm	250 mm
D-15257	25 mm	460 mm	400 mm
D-00393	26 mm	260 mm	200 mm
D-08078	26 mm	310 mm	250 mm
D-15263	26 mm	460 mm	400 mm
D-16318	28 mm	460 mm	400 mm
D-17572	30 mm	460 mm	400 mm

## Svedri SDS-Plus za les

★★★



Koda	Premer	Celotna dolžina	Delovna dolžina
B-57489	4 mm	105 mm	43 mm
B-57495	5 mm	116 mm	52 mm
B-57504	6 mm	123 mm	57 mm
B-57510	8 mm	147 mm	75 mm
B-57526	10 mm	163 mm	87 mm

## Svedri SDS-Plus za kovino

★★★★



Koda	Premer	Celotna dolžina	Delovna dolžina
B-57401	3 mm	90 mm	33 mm
B-57417	3,5 mm	100 mm	39 mm
B-57423	4 mm	105 mm	43 mm
B-57439	4,5 mm	110 mm	47 mm
B-57445	5 mm	116 mm	52 mm
B-57451	5,5 mm	123 mm	57 mm
B-57467	6 mm	123 mm	57 mm
B-57473	6,5 mm	131 mm	63 mm

## Svedri SDS-Plus za led

SPECIALIZED



Koda	Premer	Celotna dolžina	Delovna dolžina
821700-1	32 mm	450 mm	400 mm

Akumulat orji in polnilniki  
 Pribor za akumulat orske svetilke in pribor  
 Akumulat orske svetilke in pribor  
 Pribor za laserske merilnike  
 Pribor za rušenje in vrtanje  
 Pribor za vrtanje  
 Kronske žage  
 Pribor za vijačenje  
 Pribor za rezanje in brušenje  
 Pribor za poliranje in brušenje  
 Pribor za rezanje in oblanje  
 Pribor za multifunkcijsko orodje  
 Pribor za žaganje  
 Pribor za žebjalnike in spenjalnike  
 Pribor za fene  
 Pribor za sesanje  
 Pribor za uporabo na prostem  
 Pribor za nošenje orodja za oprema  
 Kovčki in torbe za orodje  
 Ročno orodje  
 Razno  
 Pribor za mešanje

## Dleta in špice SDS-Plus

### SDS-Plus špice



Koda	Širina	Celotna dolžina
D-71249	/	230 mm
B-64294	/	250 mm
P-05505	/	250 mm
P-25068	/	250 mm
D-19015	/	400 mm

### SDS-Plus špice - PREMIUM



Koda	Širina	Celotna dolžina
B-64238	/	250 mm

### SDS-Plus dleta



Koda	Širina	Celotna dolžina
D-71255	20 mm	160 mm
D-71261	20 mm	230 mm
B-64303	20 mm	250 mm
P-05511	20 mm	250 mm
P-25074	20 mm	250 mm
D-19021	20 mm	400 mm

### SDS-Plus dleta - PREMIUM



Koda	Širina	Celotna dolžina
B-64244	20 mm	250 mm

### SDS-Plus široka dleta



Koda	Širina	Celotna dolžina
D-61042	80 mm	150 mm
A-30483	40 mm	200 mm
P-05527	40 mm	200 mm

P-24941*	40 mm	200 mm
D-71277	40 mm	230 mm
B-64319	40 mm	250 mm
D-61020	80 mm	250 mm
P-24935	60 mm	250 mm
P-24957*	60 mm	250 mm

\*Ukrivljeno

### SDS-Plus široka dleta - PREMIUM



Koda	Širina	Celotna dolžina
B-64250	40 mm	250 mm

### SDS-Plus dleta za izdelovanje utorov

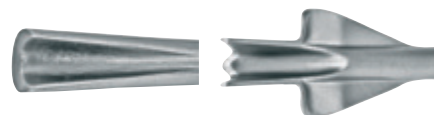

Koda	Širina	Celotna dolžina
P-25080	22 mm	240 mm
P-05533	22 mm	250 mm
P-24963*	22 mm	250 mm

\*Z vodilnimi krilci

### SDS-Plus strgala



Koda	Dimenzija	Opis
A-68161	100 x 160 mm	Strgalo
343411-9	100 mm	Nadomestno strgalo

### SDS-Plus dleta za odstranjevanje ploščic



Koda	Širina	Celotna dolžina
B-14071	40 mm	260 mm
P-63987	40 mm	260 mm

Akumulat  
orj in  
poinliniki

Pribor za  
akumulat  
orsko  
svetilke  
in pribor

Akumulat  
orske  
svetilke  
in pribor

Pribor za  
laserske  
merilnike

Pribor za  
rušenje  
in vrtanje

Pribor za  
vrtanje

Kronske  
žage

Pribor za  
vijačenje

Pribor za  
rezanje  
in  
brušenje

Pribor za  
poliranje  
in  
brušenje

Pribor za  
rezanje  
in  
oblanje

Pribor za  
multifunk  
cjsko  
orodje

Pribor za  
žaganje

Pribor za  
žebjalnike  
in  
spenjalnike

Pribor za  
fene

Pribor za  
sesanje

Pribor  
orodja za  
uporabo  
na prostem

Pribor za  
nosilne  
orodje in  
zaščitna  
oprema

Kovčki in  
torbe za  
orodje

Ročno  
orodje

Razno

Pribor za  
mešanje

## SDS-Plus dleta za les



Koda	Širina	Celotna dolžina
P-25105	20 mm	170 mm
P-25111	30 mm	170 mm

## SDS-Plus vrtalne krone

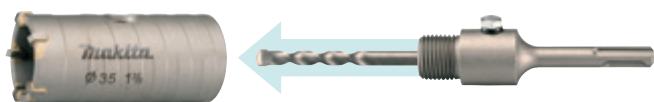

### SDS-Plus vrtalne krone

Univerzalne vrtalne krone so primerne za električarje, vodovodarje, tesarje in ostale uporabnike v splošnem gradbeništvu. Z vrtalnimi kronami lahko režete številine materiale kot so opeka, mavčne plošče, plastika, vezane plošče, les, in iverne plošče. Z močnimi in vzdržljivimi TCT zobmi zagotavljajo odlične rezultate.



Koda	Premer	Celotna dolžina	Globina vrtanja
D-73891	30 mm	72 mm	50 mm
D-73900	35 mm	72 mm	50 mm
D-73916	40 mm	72 mm	50 mm
D-73922	50 mm	72 mm	50 mm
D-73938	68 mm	72 mm	50 mm
D-73944	82 mm	72 mm	50 mm
D-73950	90 mm	72 mm	50 mm
D-73966	100 mm	72 mm	50 mm

### SDS-Plus centrini svedri za vrtalne krone



Koda	Premer	Celotna dolžina	Globina vrtanja
D-73972	8 mm	110 mm	60 mm

### SDS-Plus adapterji za vrtalne krone



Koda	Premer	Celotna dolžina	Globina vrtanja
D-73988	/	110 mm	/
D-73994	/	200 mm	/
D-74005	/	350 mm	/

## SDS-Plus seti vrtalnih kron



Koda	Premer	Celotna dolžina	Globina vrtanja
D-74011	68 mm	182 mm	50 mm
D-74027	82 mm	182 mm	50 mm

## SDS-Plus vrtalne glave in adapterji

### Hitromenjalne cilindrične glave



Koda	Za model
191F46-4	HR3012FCJ
194079-2	DHR243, HR2450FT, HR2450T, HR2470FT, HR2470T, HR2610T, HR2611FT, HR2630T, HR2631FT, HR2651T, HR2653T, HR2810T, HR2811FT
194568-7	HR3210FCT
196173-6	HR2630T, HR2631FT
199139-5	DHR281, DHR283, HR002G, HR004G

### Hitromenjalne glave SDS-Plus



Koda	Za model
125420-8	HR3210FCT
191F47-2	HR3011FCJ, HR3012FC
194080-7	DHR243, HR2450FT, HR2450T, HR2470FT, HR2470T, HR2610T, HR2611FT, HR2630T, HR2631FT, HR2651T, HR2653T, HR2810T, HR2811FT
199138-7	DHR281, DHR283, HR002G, HR004G

### Adapterji SDS-Plus za samozatezne glave



Koda	Navoj glave	Posebnost
122573-4	1/2" - 20 UNF	
D-14093	1/2" - 20 UNF	Ni za udarno vrtanje



# Pribor za rušenje in vrtanje

## Adapter SDS-Plus z glavo z zobatim vencem



Koda	Vpetje	Vsebuje zatezni ključ
122574-2	SDS-Plus - 13 mm	Ne
P-34833	SDS-Plus - 13 mm	Da

## Adapter SDS-Plus za vijačne nastavke



Koda	Dolžina	Vpetje
P-21646	78 mm	1/4"

## Hitrovpenjalno držalo vijačnih nastavkov, SDS-Plus



Koda	Dolžina	Vpetje
B-57548	80 mm	1/4"

P-77774	18 mm	340 mm	200 mm
P-77780	18 mm	540 mm	400 mm
P-77796	18 mm	940 mm	800 mm
P-77805	18 mm	1320 mm	1180 mm
P-77811	20 mm	320 mm	200 mm
P-77827	20 mm	520 mm	400 mm
P-77833	20 mm	920 mm	800 mm
P-77849	20 mm	1320 mm	1200 mm
P-77855	22 mm	320 mm	200 mm
P-77861	22 mm	520 mm	400 mm
P-77877	22 mm	920 mm	800 mm
P-77883	22 mm	1320 mm	1200 mm
P-77899	24 mm	320 mm	200 mm
P-77908	24 mm	520 mm	400 mm
P-77914	25 mm	320 mm	200 mm
P-77920	25 mm	520 mm	400 mm
P-77936	25 mm	920 mm	800 mm
P-77942	25 mm	1320 mm	1180 mm
P-77958	26 mm	520 mm	400 mm
P-77964	28 mm	370 mm	250 mm
P-77970	28 mm	570 mm	450 mm
P-77986	28 mm	670 mm	550 mm
P-77992	28 mm	920 mm	800 mm
P-78003	28 mm	1320 mm	1200 mm
P-78019	30 mm	370 mm	250 mm
P-78025	30 mm	570 mm	450 mm
P-78031	32 mm	370 mm	250 mm
P-78047	32 mm	570 mm	450 mm
P-78053	32 mm	920 mm	800 mm
P-78069	32 mm	1320 mm	1200 mm
P-78075	35 mm	370 mm	250 mm
P-78081	35 mm	570 mm	450 mm
P-78097	35 mm	670 mm	550 mm
P-78592	35 mm	1320 mm	1200 mm
P-78106	37 mm	370 mm	250 mm
P-78112	37 mm	570 mm	450 mm
P-78128	37 mm	920 mm	800 mm
P-78134	38 mm	370 mm	250 mm
P-78140	38 mm	570 mm	450 mm
P-78156	40 mm	370 mm	250 mm
P-78162	40 mm	570 mm	450 mm
P-78178	40 mm	920 mm	800 mm
P-78184	40 mm	1320 mm	1200 mm
P-78190	45 mm	570 mm	450 mm
P-78209	45 mm	920 mm	800 mm
P-78215	50 mm	570 mm	450 mm
P-78221	52 mm	570 mm	450 mm

## Pribor za vrtalna in rušilna kladiva s SDS-MAX vpetjem

### Svedri SDS-MAX MAK4



Premium SDS-MAX sveder z dinamično oblikovano štirirezno konico. Simetrična zasnovana konica s centrino špičo zagotavlja optimalne rezultate v primeru kontakta z ojačitvenimi palicami. Skrajšani in konusno oblikovani spiralni utori za odvajanje prahu omogočajo izjemno hitro odvajanje prahu in odrezkov v dvojni utor z večjo prostornino. MAK4 svedri imajo visoke parametre vrtnalnih hitrosti in pričakovane življenjske dobe. Diametri 12 - 15 mm so dvoresni svedri.

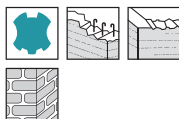

Koda	Premer	Celotna dolžina	Delovna dolžina
P-17033	12 mm	340 mm	200 mm
P-17049	12 mm	540 mm	400 mm
P-17055	12 mm	690 mm	550 mm
P-17077	14 mm	340 mm	200 mm
P-17083	14 mm	540 mm	400 mm
P-17108	15 mm	340 mm	200 mm
P-17114	15 mm	540 mm	400 mm
P-77730	16 mm	340 mm	200 mm
P-77746	16 mm	540 mm	400 mm
P-77752	16 mm	940 mm	800 mm
P-77768	16 mm	1320 mm	1180 mm

### TCT štirirezni svedri SDS-MAX

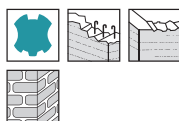

Koda	Premer	Celotna dolžina	Delovna dolžina
E-11324	12 mm	340 mm	200 mm
E-11330	12 mm	540 mm	400 mm
E-11346	14 mm	340 mm	200 mm
E-11352	14 mm	540 mm	400 mm
E-11368	16 mm	340 mm	200 mm

Akumulat orji in polnilniki

Pribor za akumulat orske svetilke in pribor

Pribor za laserske merilnike

Pribor za rušenje in vrtanje

Pribor za vrtanje

Kronске žage

Pribor za vijačenje

Pribor za rezanje in brušenje

Pribor za poliranje in brušenje

Pribor za rezkanje in oblanje

Pribor za multifunkcijsko orodje

Pribor za rezganje

Pribor za žebrijalnice in spenjalnice

Pribor za fene

Pribor za sesanje

Pribor za uporabo na prostem

Pribor za ročno orodje

Razno orodje

Pribor za mešanje

# Pribor za rušenje in vrtanje

E-11374	16 mm	540 mm	400 mm
E-11380	18 mm	340 mm	200 mm
E-11396	18 mm	540 mm	400 mm
E-11405	20 mm	340 mm	200 mm
E-11411	20 mm	540 mm	400 mm
E-11427	22 mm	340 mm	200 mm
E-11433	22 mm	540 mm	400 mm
E-11449	24 mm	340 mm	200 mm
E-11455	24 mm	540 mm	400 mm
E-11461	25 mm	340 mm	200 mm
E-11477	25 mm	540 mm	400 mm
E-11483	28 mm	370 mm	250 mm
E-11499	28 mm	570 mm	450 mm
E-11508	30 mm	370 mm	250 mm
E-11514	30 mm	570 mm	450 mm

## Svedri SDS-MAX Standard

★★

Dvovrezni SDS-MAX svedri so primerni za vrtanje v zidane stene in beton. Kvalitetna karbidna konica s centrino špico in izboljšanimi utori za odvajanje prahu in odrezkov omogoča višje vrtnalne hitrosti.



Koda	Premer	Celotna dolžina	Delovna dolžina
D-33875	12 mm	340 mm	200 mm
D-33881	12 mm	540 mm	400 mm
D-33897	14 mm	340 mm	200 mm
D-33906	14 mm	540 mm	400 mm
D-33912	15 mm	340 mm	200 mm
D-33928	15 mm	540 mm	400 mm
D-33934	16 mm	340 mm	200 mm
D-33940	16 mm	540 mm	400 mm
D-33956	18 mm	340 mm	200 mm
D-33962	18 mm	540 mm	400 mm
D-33978	20 mm	340 mm	200 mm
D-33984	20 mm	540 mm	400 mm
D-33990	22 mm	340 mm	200 mm
D-34001	22 mm	540 mm	400 mm
D-34017	24 mm	340 mm	200 mm
D-34023	24 mm	540 mm	400 mm
D-34039	25 mm	340 mm	200 mm
D-34045	25 mm	540 mm	400 mm
D-34051	28 mm	370 mm	250 mm
D-34067	28 mm	570 mm	450 mm
D-34073	30 mm	370 mm	250 mm
D-34089	30 mm	570 mm	450 mm
D-34095	32 mm	370 mm	250 mm
D-34104	32 mm	570 mm	450 mm
D-34110	35 mm	370 mm	250 mm
D-34126	35 mm	570 mm	450 mm
D-34132	38 mm	370 mm	250 mm
D-34148	38 mm	570 mm	450 mm
D-34154	40 mm	370 mm	250 mm
D-34160	40 mm	570 mm	450 mm

## Svedri SDS-MAX ZENTRO za rudarstvo

SPECIALIZED

SDS-MAX ZENTRO sveder za rudarstvo s karbidno konico ima izjemno čvrsto zasnovano geometrijo, ki omogoča visoko odpornost in delo v najzahtevnejših pogojih. S svedri SDS-MAX ZENTRO je zmogljivost vrtanja v naravni kamen tudi do 25% večja kot z običajnimi SDS-MAX svedri. Stranski karbidni robovi aktivno pripomorejo k zaščiti karbidne konice, saj so izdelani simetrično z razmikom 4x90°.



Koda	Premer	Celotna dolžina	Delovna dolžina
B-15039	28 mm	670 mm	550 mm
B-14613	32 mm	570 mm	450 mm
B-15045	32 mm	920 mm	800 mm

## Prebojni svedri SDS-MAX

★★★★

SDS-MAX prebojni svedri z zmogljivostjo vrtanja od 40 do 80 mm v beton, kamen in naravni kamen. HM centrino konica omogoča hitro vrtanje. Lahka konica je primerna za hitro odstranjevanje odrezkov. Za uporabo s kombiniranimi klavidi s težo nad 8 kg. Enodelna konstrukcija.



Koda	Premer	Celotna dolžina	Delovna dolžina
B-57629	40 mm	550 mm	450 mm
B-57635	45 mm	550 mm	450 mm
B-57641	45 mm	990 mm	850 mm
B-57657	55 mm	550 mm	450 mm
B-57663	55 mm	990 mm	850 mm
B-57679	65 mm	550 mm	450 mm
B-57685	65 mm	990 mm	850 mm
B-57691	80 mm	550 mm	450 mm
B-57700	80 mm	990 mm	850 mm

## Nastavek za zabijanje klinov SDS-MAX



Koda	Premer	Celotna dolžina
E-13029	13,3 mm	260 mm
E-13035	16,5 mm	260 mm
E-13041	22,2 mm	260 mm

## Dleta in špice SDS-MAX

### SDS-MAX špice



Koda	Širina	Celotna dolžina
P-16237	/	280 mm
D-34176	/	300 mm
B-64325	/	400 mm
D-34182	/	400 mm
P-16243	/	400 mm
D-34198	/	600 mm
P-16259	/	600 mm

### SDS-MAX špice - samoostrične

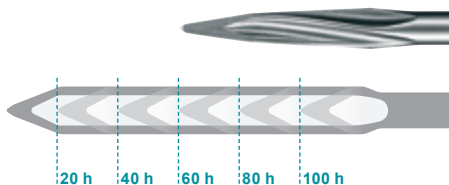

Koda	Širina	Celotna dolžina
B-10366	/	400 mm
B-23064	/	400 mm

### SDS-MAX špice - PREMIUM



Koda	Širina	Celotna dolžina
B-64266	/	400 mm

### SDS-MAX dleta



Koda	Širina	Celotna dolžina
P-16265	25 mm	280 mm
D-34207	25 mm	300 mm
B-64331	25 mm	400 mm
D-34213	25 mm	400 mm
P-16271	25 mm	400 mm
D-34229	25 mm	600 mm
P-16287	25 mm	600 mm

### SDS-MAX dleta - samoostrična



Koda	Širina	Celotna dolžina
B-14015	50 mm	350 mm

### SDS-MAX dleta - PREMIUM



Koda	Širina	Celotna dolžina
B-64272	25 mm	400 mm

### SDS-MAX široka dleta



Koda	Širina	Celotna dolžina
D-34241	80 mm	300 mm
P-16318	80 mm	300 mm
P-16302	50 mm	360 mm
B-64347	50 mm	380 mm
D-34235	50 mm	400 mm

### SDS-MAX široka dleta - PREMIUM



Koda	Širina	Celotna dolžina
B-64288	50 mm	400 mm

### SDS-MAX dleta za izdelovanje utorov

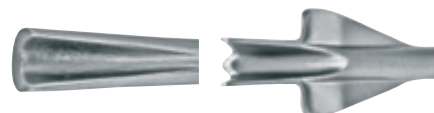

Koda	Širina	Celotna dolžina
P-16293	26 mm	300 mm
P-16330*	35 mm	380 mm

\*Z vodilnimi krilci

Akumulat orji in polnilniki  
 Pribor za akumulat orsko orodje  
 Akumulat orske svetilke in pribor  
 Pribor za laserske merilnike  
 Pribor za rušenje in vrtanje  
 Pribor za vrtanje  
 Kronske žage  
 Pribor za vijachenje  
 Pribor za rezanje in brušenje  
 Pribor za poliranje in brušenje  
 Pribor za rezkanje in oblanje  
 Pribor za multifunk cjsko orodje  
 Pribor za žaganje  
 Pribor za žebjalnike in spenjalnike  
 Pribor za fene  
 Pribor za sesanje  
 Pribor za uporabo na prostem  
 Pribor za ročno orodje in zaščitna oprema  
 Kovčki in orodje  
 Ročno orodje  
 Razno  
 Pribor za mešanje

## SDS-MAX plošče za rebričenje

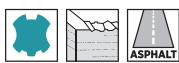

Koda	Dimenzija	Opis
P-03947	60 x 60 mm	Plošča za rebričenje
P-16352	220 mm	Gred za ploščo za rebričenje

## SDS-MAX dleta za odstranjevanje malte



Koda	Širina	Celotna dolžina
P-16346	38 mm	280 mm

## SDS-MAX dleta za odstranjevanje ploščic



Koda	Širina	Celotna dolžina
P-16324	50 mm	300 mm

## SDS-MAX lopatasta dleta



Koda	Širina	Celotna dolžina
P-23721	110 mm	400 mm

## SDS-MAX adapterji

### Adapter SDS-MAX na SDS-Plus



Koda	Vpetje	Celotna dolžina
P-17027	SDS-MAX/SDS-Plus	220 mm

## Dleta in špice, 6-kotno vpetje, 17 mm

### Špice



Koda	Širina	Dolžina	Posebnost
D-08682	/	280 mm	
P-13035	/	280 mm	
D-16863	/	450 mm	
P-13041	/	450 mm	

### Dleta



Koda	Širina	Dolžina	Posebnost
A-80569	17 mm	280 mm	
D-08707	17 mm	280 mm	
P-13057	25 mm	280 mm	
D-16879	19 mm	450 mm	
P-13063	17 mm	450 mm	

### Široka dleta



Koda	Širina	Dolžina	Posebnost
D-20694	50 mm	280 mm	
P-13079	45 mm	280 mm	

### Dleta za izdelovanje utorov



Koda	Širina	Dolžina	Posebnost
A-48561	26 mm	280 mm	



# Pribor za rušenje in vrtanje

## Lopatasto dleto



Koda	Širina	Dolžina	Posebnost
P-13085	110 mm	400 mm	

## Teptalo z gredjo

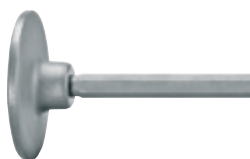

Koda	Širina	Dolžina	Posebnost
A-21428	140 mm	265 mm	

## Dleta in špice, 6-kotno vpetje, 19 mm, B-tip

### Špice



Koda	Širina	Dolžina	Posebnost
P-05620	/	400 mm	
P-05614	/	600 mm	

### Dleta



Koda	Širina	Dolžina	Posebnost
P-05636	25 mm	400 mm	
P-05642	25 mm	600 mm	

## Dleta in špice, 6-kotno vpetje, 19 mm

### Špice



Koda	Širina	Dolžina	Posebnost
P-13340	/	220 mm	

### Dleta



Koda	Širina	Dolžina	Posebnost
P-13356	30 mm	150 mm	

### Široka dleta



Koda	Širina	Dolžina	Posebnost
P-05474	50 mm	190 mm	
P-13362	50 mm	190 mm	

### Široka dleta



Koda	Širina	Dolžina	Posebnost
P-05664	60 mm	300 mm	

## Dleta in špice, 6-kotno vpetje, 19 mm, K-tip

### Dleta za izdelovanje utorov



Koda	Širina	Dolžina	Posebnost
P-13188	22 mm	250 mm	

Akumulat orji in polnilniki  
 Pribor za akumulat orsko orodje  
 Akumulat orske svetilke in pribor  
 Pribor za lasarske merilnike  
 Pribor za rušenje in vrtanje  
 Pribor za vrtanje  
 Kronske žage  
 Pribor za vijačenje  
 Pribor za rezanje in brušenje  
 Pribor za poliranje in brušenje  
 Pribor za rezkanje in oblanje  
 Pribor za multitfunkcijsko orodje  
 Pribor za žaganje  
 Pribor za žebjalnike in spenjalnike  
 Pribor za fene  
 Pribor za sesanje  
 Pribor orodja za uporabo na prostem  
 Pribor za nosenje orodja za zaščitna oprema  
 Kovčki in torbe za orodje  
 Ročno orodje  
 Razno  
 Pribor za mešanje

# Pribor za rušenje in vrtanje

## Dleta in špice, 6-kotno vpetje, 21 mm

### Špice



Koda	Širina	Dolžina	Posebnost
P-13378	/	320 mm	
P-13384	/	450 mm	
P-13390	/	600 mm	

### Dleta



Koda	Širina	Dolžina	Posebnost
P-13409	26 mm	320 mm	
P-13415	26 mm	450 mm	
P-13421	26 mm	600 mm	

### Široka dleta



Koda	Širina	Dolžina	Posebnost
P-13437	70 mm	320 mm	

## Dleta in špice, 6-kotno vpetje, 28,6 mm, B-tip

### Špice



Koda	Širina	Dolžina	Posebnost
D-65034	/	350 mm	
B-10372	/	400 mm	Samoostrilna
P-05692	/	400 mm	
D-17631	/	410 mm	
D-61531	/	410 mm	
P-19180	/	500 mm	
D-17675	/	520 mm	
D-61569	/	520 mm	

### Dleta



Koda	Širina	Dolžina	Posebnost
P-05723	29 mm	400 mm	
D-17647	28 mm	410 mm	
D-17681	28 mm	520 mm	
D-61547	28 mm	410 mm	Brez roba
D-61575	28 mm	520 mm	Brez roba

### Široka dleta



Koda	Širina	Dolžina	Posebnost
P-05701	80 mm	400 mm	
D-61553	75 mm	410 mm	Brez roba
D-61581	75 mm	520 mm	Brez roba

### Lopatasta dleta



Koda	Širina	Dolžina	Posebnost
P-05717	125 mm	400 mm	

## Dleta in špice, 6-kotno vpetje, 30 mm

### Špice



Koda	Širina	Dolžina	Posebnost
B-10388	/	400 mm	Samoostrilna
P-05549	/	400 mm	
P-05561	/	700 mm	
P-05577	/	1.000 mm	

# Pribor za rušenje in vrtanje

## Dleta



Koda	Širina	Dolžina	Posebnost
P-13487	32 mm	400 mm	
P-13502	32 mm	400 mm	HM1400
P-05583	32 mm	700 mm	
P-05599	32 mm	1.000 mm	

## Široka dleta



Koda	Širina	Dolžina	Posebnost
P-13493	115 mm	400 mm	HM1400
P-13518	115 mm	400 mm	

## Lopatasta dleta



Koda	Širina	Dolžina	Posebnost
P-05555	125 mm	400 mm	
P-05608	125 mm	400 mm	HM1400

## Teptalo z gredjo



Koda	Širina	Dolžina	Posebnost
A-86941	200 mm	255 mm	

## Prebojni svedri z navojnim členom in pribor

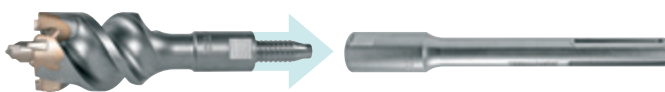

### Prebojni svedri z navojnim členom

Prebojne svedre za beton odlikuje hitra montaža, vrtanje lukenj s končnim premerom brez predhodnega povrtavanja in bistveno boljše zmogljivost vrtanja v primerjavi z vrtalnimi kronami, še posebej pri vrtanju v armiran beton. Rezultat so natančne, okrogle izvrtine z ravnim dnom. Globino vrtanja lahko povečamo z uporabo podaljška, homogena konstrukcija pa poskrbi za prenašanje energije na prebojni sveder brez izgube moči.



Koda	Premer
P-04008	35 mm
P-03844	40 mm
P-03850	50 mm
P-04014	55 mm
P-04020	60 mm
P-03866	68 mm
P-03872	80 mm
P-04036	90 mm

### Adapter za prebojni sveder



Koda	Opis
P-03903	160 mm, HEX 13
P-03888	185 mm, SDS-MAX

### Podaljšek za prebojni sveder



Koda	Dolžina
P-03925	280 mm

### Navojni člen



Koda	Dolžina
P-03931	60 mm

Akumulat  
orji in  
poinliniki

Pribor za  
akumulat  
orsko  
orodje

Akumulat  
orske  
svetilke  
in pribor

Pribor za  
lasarske  
merilnike

Pribor za  
rušenje  
in vrtanje

Pribor za  
vrtanje

Kronske  
žage

Pribor za  
vijačenje

Pribor za  
rezanje  
in  
brušenje

Pribor za  
poliranje  
in  
brušenje

Pribor za  
rezkanje  
in  
oblanje

Pribor za  
multifunk  
ciljsko  
orodje

Pribor za  
žaganje

Pribor za  
žebjalnike  
in  
spenjalnike

Pribor za  
fene

Pribor za  
sesanje

Pribor  
orodja za  
uporabo  
na prostem

Pribor za  
ročno  
orodje za  
zaščita  
oprema

Kovčki in  
torbe za  
orodje

Ročno  
orodje

Razno

Pribor za  
mešanje

## MAK-povezovalni sistem

Sistem podaljškov in povezovalnega člena omogoča varno in hitro povezavo med orodjem, podaljškom in priborom za vrtanje. Povezovalni člen zagotavlja povezavo brez izgube prenosa energije. Celotna energija se prenaša na pribor za vrtanje ter omogoča delo z najvišjo možno močjo. MAK-povezovalni sistem je izjemno vzdržljiv zato je možnost poškodb zaradi preobremenitve malo verjetna. Uporaba je možna z SDS-MAX svedri s premeri nad 32 mm.

### Podaljški SDS-MAX na SDS-MAX



Koda	Vpetje	Celotna dolžina
P-53920	SDS-MAX/SDS-MAX	320 mm
P-53936	SDS-MAX/SDS-MAX	750 mm
P-53942	SDS-MAX/SDS-MAX	1.100 mm

### Podaljški GKW na SDS-MAX



Koda	Vpetje	Celotna dolžina
P-53958	GKW/SDS-MAX	320 mm

### Povezovalni člen



Koda	Vpetje	Celotna dolžina
P-53914	SDS-MAX/SDS-MAX	190 mm

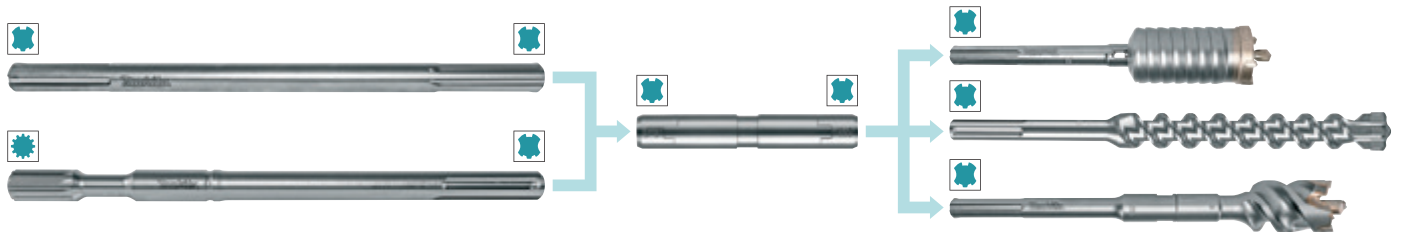



# Pribor za rušenje in vrtanje

## Vrtalne krone s konusnim vpetjem in pribor



### Vrtalne krone s konusnim vpetjem

Vrtalne krone se uporabljajo za vrtanje v beton, zidane stene in kamen. Izjemna stabilnost vrtenja in dobra natančnost, ki je dosežena s poševno oblikovanimi vodilnimi zobmi. Ravni stranski zobje pa zagotavljajo visoko učinkovitost vrtanja.



Koda	Premer	Globina vrtanja
P-03779	40 mm	60 mm
P-03785	50 mm	60 mm
P-03791	65 mm	60 mm
P-03800	80 mm	60 mm
P-03816	90 mm	60 mm
P-03822	100 mm	60 mm
P-16374	125 mm	60 mm

### Adapter za vrtalne krone s konusnim vpetjem



Koda	Celotna dolžina	Vpetje
P-03729	185 mm	13 mm HEX
P-03735	450 mm	13 mm HEX
P-16994	180 mm	SDS-MAX
P-17005	450 mm	SDS-MAX

### Centrirni sveder za vrtalne krone s konusnim vpetjem



Koda	Celotna dolžina
P-03838	11x120 mm

### Izbijalni klin za snemanje vrtalnih kron s konusnim vpetjem



Koda	Celotna dolžina
P-03763	140 mm

## Ostali pribor

### Maziva



Koda	Naziv
195127-0	Mast za mazanje svedrov in dlet 30 g
198993-4	Mast za mazanje svedrov in dlet 100 g

### Transportni vozički



Koda	Naziv	Za model
D-54972	Transportni voziček	HM1800, HM1801, HM1802, HM1810, HM1812



## Seti za vrtalna in rušilna kladiva s SDS-Plus vpetjem

Kakovostni razred	Koda	Št. Kosov	Dimenzije			Kovček
			Dleta	Svedri	Špice	
★★★★★	B-58992	5	/	5, 6x115 mm; 6, 8, 10x165 mm	/	
★★★★★	B-59075	3	/	6, 8, 10x165 mm	/	
★★★★	B-49046	7	/	5, 6, 8x110 mm; 6, 8, 10, 12x160 mm	/	
★★★★	P-29751	5	/	5, 6, 8x110 mm; 6, 8x160 mm	/	
★★★★	B-54704	5	/	6x110 mm; 8, 10x160 mm	/	
★★★★	B-57532	5	/	Les: 4x105 mm, 5x116 mm, 6x123 mm; HSS-TiN: 3x90 mm, 4x105 mm	/	
★★★★	E-14249	4	/	5 x 110 mm, 6, 8, 10 x 160 mm	/	
★★	D-00795	5	/	5, 6, 8x110 mm; 6, 8x160 mm	/	
★★	D-17784	5	/	6, 6.5x110 mm; 8, 10, 12x160 mm	/	
★★	D-20703	5	/	5, 6, 7, 8, 10x160 mm	/	
★★	D-36049	5	/	6, 6, 8, 10, 12x160 mm	/	
★★	D-58914	5	/	5, 6, 6, 8, 8x160 mm	/	
★★	D-61678	5	/	6, 8x110 mm; 6, 8, 10x160 mm	/	
★★	D-40602	25	/	5x (5, 6, 8x110 mm); 5x (6, 8x160 mm)	/	
★★★★	E-04911	3	20x250 mm; 40x250 mm	/	250 mm	
★★★★	E-13188	5	2 x (20x250 mm), 40x250 mm	/	2 x 250 mm	
★★	D-42357	3	20x250 mm; 40x250 mm	/	250 mm	
★★	D-71314	3	20x230 mm; 40x230 mm	/	230 mm	
★★	D-42363	4	2x (20x250 mm)	/	2x250 mm	
★★	D-42379	5	2x (20x250 mm); 40x250 mm	/	2x250 mm	
★★	D-58920	6	20x250 mm; 40x250 mm	5, 6, 8x160 mm	250 mm	
★★	D-21191	10	20x250 mm	5, 5, 6x110 mm; 7, 8x160 mm; 10x210 mm; 10, 16, 20x460 mm	250 mm	
★★	D-42385	10	20x250 mm	6x110 mm; 8x160 mm; 10, 12x210 mm; 10, 12, 16, 20x460 mm	250 mm	
★★	D-20111	13	20x250 mm	5, 6, 7, 8x110 mm; 6, 7, 8, 10, 12, 14x160 mm; 16x210 mm	250 mm	
★★	D-53659	13	20x250 mm	5, 6, 7, 8x110 mm; 6, 7, 8, 10, 12, 14, 16x160 mm	250 mm	
★★	D-71174	14	20x250 mm	5, 6, 7, 8x110 mm; 6, 7, 8, 10, 12, 14, 16x160 mm	250 mm	
★★	B-52059	17	20x140 mm; 20x250 mm; 40x250 mm	5, 5, 5, 6, 7x110 mm; 5, 5, 6, 7, 8, 10x160 mm; 8, 10x210 mm; 14x260 mm	140 mm; 250 mm	
★★	B-53877	17	20x140 mm; 20x250 mm; 40x250 mm	5, 6, 7, 8x110 mm; 5, 6, 7, 10x160 mm; 8, 10, 12x210 mm; 14x260 mm	140 mm; 250 mm	
★★	D-21200	17	20x140 mm; 20x250 mm; 40x250 mm	5, 5, 5, 6, 8, 10x110 mm; 6, 7, 8, 10x160 mm; 8, 10x210 mm; 14x260 mm	140 mm; 250 mm	
★★	D-42444	17	20x140 mm; 20x250 mm; 40x250 mm	5, 6, 8, 10x110 mm; 6, 8, 10, 12x160 mm; 8, 10x210 mm; 12, 14x260 mm	140 mm; 250 mm	
★★	D-71180	18	20x140 mm; 20x250 mm; 40x250 mm	5, 6, 8, 10x110 mm; 6, 8, 10, 12x160 mm; 8, 10x210 mm; 10, 12x260 mm	140 mm; 250 mm	
★★	D-71196	18	20x140 mm; 20x250 mm; 40x250 mm	5, 6, 8, 10x110 mm; 6, 8, 10, 12x160 mm; 8, 10x210 mm; 12, 14x260 mm	140 mm; 250 mm	

## Seti za vrtalna in rušilna kladiva s SDS-MAX vpetjem

Kakovostni razred	Koda	Št. Kosov	Dimenzije			Kovček
			Dleta	Svedri	Špice	
Specialized	P-52445	5	25x400 mm; 50x400 mm	25, 25x520 mm; 32x570 mm	400 mm	
★★★★	E-13194	5	2 x (25x400 mm), 50x350 mm	/	2 x 400 mm	
★★	D-42450	3	25x400 mm; 50x400 mm	/	400 mm	
★★	D-42466	4	25x300 mm; 25x400 mm	/	300 mm; 400 mm	
★★	P-18013	4	25x280 mm; 25x400 mm	/	280 mm; 400 mm	
★★	D-42488	6	2x (25x400 mm); 50x400 mm; 80x300 mm	/	2 x 400 mm	



plastični kovček



kovinski kovček



MAK PAC kovček

# Pribor za rušenje in vrtanje

B-58992	B-59075	B-49046	P-29751	B-54704	B-57532	E-14249
D-00795	D-17784	D-20703	D-36049	D-58914	D-61678	D-40602
E-04911	E-13188	D-42357	D-71314	D-42363	D-42379	
D-58920	D-21191	D-42385	D-20111	D-53659	D-71174	
B-52059	B-53877	D-21200	D-42444	D-71180	D-71196	
P-52445	E-13194	D-42450	D-42466	P-18013	D-42488	

Akumulat  
 orji in  
 polnilniki  
 Pribor za  
 akumulat  
 orsko  
 orodje  
 Akumulat  
 orske  
 svetilke  
 in pribor  
 Pribor za  
 lasarske  
 merilnike  
 Pribor za  
 rušenje  
 in vrtanje  
 Pribor za  
 vrtanje  
 Kronske  
 žage  
 Pribor za  
 vijačenje  
 Pribor za  
 rezanje  
 in  
 brušenje  
 Pribor za  
 poliranje  
 in  
 brušenje  
 Pribor za  
 rezkanje  
 in  
 oblanje  
 Pribor za  
 multitank  
 ciljsko  
 orodje  
 Pribor za  
 žaganje  
 Pribor za  
 žebjalnike  
 in  
 spenjalnike  
 Pribor za  
 fene  
 Pribor za  
 sesanje  
 Pribor  
 orodja za  
 uporabo  
 na prostem  
 Pribor za  
 nosenje  
 orodja  
 zaščitna  
 oprema  
 Kovčki in  
 torbe za  
 orodje  
 Ročno  
 orodje  
 Razno  
 Pribor za  
 mešanje







# Pribor za rušenje in vrtanje

67

## Odsesovalni pribor za vrtalna in rušilna kladiva s SDS-Plus/SDS-MAX vpetjem

### Odsesovalni nastavki

Koda	Naziv	Za model	Cena z DDV	
122709-5	Odsesovalni nastavek	HR2432		
191E54-9	Odsesovalni nastavek, model DX12	HR001G, HR003G		
191E60-4	Odsesovalni nastavek, model DX14	HR002G, HR004G		
191F49-8	Posoda za prah za DX10,11	DX10, DX11		
191F95-1	Odsesovalni nastavek DX10	HR3011FC		
191G00-4	Odsesovalni nastavek DX11	HR3012FC		
191L91-5	Adapter za odsesovalni nastavek 195173-3	HR3011FC, HR3001C		
191M20-4	Odsesovalni nastavek s cevjo	HM1501, HM1502, HM1512		
191M21-2	Odsesovalni nastavek	HM1501, HM1502, HM1512		
192176-8	Odsesovalni nastavek	DHR200, HR160D, HR1800, HR2010		
193472-7	Odsesovalni nastavek	DHR202, DHR241, HR2020, HR2440, HR2440F, HR2440X, HR2450, HR2450F, HR2450T, HR2470, HR2810, HR2811		
194581-5	Adapter za odsesovalni nastavek SDS-Plus 198362-9	DHR165, DHR171, DHR182, HR140D, HR166D, HR1830, HR1840, HR1841F		

Nadaljevanje...

Akumulat  
ori in  
poinliniki

Pribor za  
akumulat  
orsko  
orodje

Akumulat  
orske  
svetilke  
in pribor

Pribor za  
laserske  
merilnike

Pribor za  
rušenje  
in vrtanje

Pribor za  
vrtanje

Kronske  
žage

Pribor za  
vijačenje

Pribor za  
rezanje  
in  
brušenje

Pribor za  
poliranje  
in  
brušenje

Pribor za  
rezkanje  
in  
oblanje

Pribor za  
multifunk  
cjsko  
orodje

Pribor za  
žaganje

Pribor za  
žebjalnike  
in  
spenjalnike

Pribor za  
fene

Pribor za  
sesanje

Pribor  
orodja za  
uporabo  
na prostem

Pribor za  
prostoje  
orodja in  
zaščitna  
oprema

Kovčki in  
torbe za  
orodje

Ročno  
orodje

Razno

Pribor za  
mešanje

# Pribor za rušenje in vrtanje

	Koda	Naziv	Za model	Cena z DDV
Akumulat orj in polnilniki				
Pribor za akumulat orsko orodje				
Akumulat orske svetilke in pribor				
Pribor za lasarske merilnike				
Pribor za rušenje in vrtanje				
Pribor za vrtanje				
Kronske žage				
Pribor za vijačenje				
Pribor za rezanje in brušenje				
Pribor za poliranje in brušenje				
Pribor za rezkanje in oblanje				
Pribor za multitank orodje				
Pribor za žaganje				
Pribor za žebjalnike in spenjalnike				
Pribor za fene				
Pribor za sesanje				
Pribor orodja za uporabo na prostem				
Pribor za nosenje in zaščita oprema				
Kovčki in torbe za orodje				
Ročno orodje				
Razno				
Pribor za mešanje				
	195173-3	Odsesovalni nastavek	HR2300, HR2600, HR2610, HR2611F, HR3011FC, HR3001C, HR007G	
	195179-1	Odsesovalni nastavek	DHR243, HR2300, HR2310T, HR2600, HR2320T, HR2630T/F, HR2361FT, HR2641, HR2653T, HR2652, HR2653, HR3012FC	
	195866-2	Odsesovalni nastavek SDS-MAX	HR4001C, HR4002, HR4010C, HR4011C, HR4501C, HR4510C, HR4511C	
	196535-8	Odsesovalni nastavek SDS-MAX	HR4013C, HR4003C, HR4002	
	196861-5	Odsesovalni nastavek SDS-MAX	HR5202C, HR5212C, HR5201C, HR5211C	
	197148-8	Odsesovalni nastavek s cevjo	HM1304/B, HM1317C/CB, HM1801, HM1802, HM1810, HM1812	
	197168-2	Odsesovalni nastavek	HM1304/B, HM1317C/CB, HM1801, HM1802, HM1810, HM1812	
	198362-9	Odsesovalni nastavek SDS-Plus	DHR165, DHR171, DHR182, HR140D, HR166D, HR1830, HR1840, HR1841F	
	198981-1	Posoda za prah HR2650, HR2651	HR2650, HR2651	
	199142-6	Odsesovalni nastavek	DHR400, HR005G, HR4003C, HR4013C	
	199143-4	Odsesovalni nastavek	DHR400, HM001G, HM002G, HR005G, HR006G, HM0870C, HM0871C, HM1101C, HM1111C, HM1203C, HM1213C, HM1214C, HR3530, HR3540C, HR3541FC, HR4002, HR4003C, HR4013C, HR4501C, HR4511C, HR5212C, HR5202C	
	199144-2	Odsesovalni nastavek s cevjo	DHR400, HM001G, HM002G, HR005G, HR006G, HM0870C, HM0871C, HM1101C, HM1111C, HM1203C, HM1213C, HM1214C, HR3530, HR3540C, HR3541FC, HR4002, HR4003C, HR4013C, HR4501C, HR4511C, HR5212C, HR5202C	
	199555-1	Posoda za prah s filtrom DX08	DX06, DX07, DX08, DX09, DX12, DX14	

[Nadaljevanje...](#)







# Pribor za rušenje in vrtanje

Koda	Naziv	Za model	Cena z DDV	
199557-7	Hepa filter DX02,3,4,6,7,8,9,12,14,15	DX01, DX02, DX06, DX07, DX08, DX09, DX12, DX14, DX15, HR2650, HR2651, HR2651T, HR2661 HR2652, HR2653, HR2653T, HR2663, HR007G		
199572-1	Odsesovalni nastavek, model DX07	DHR243		
199581-0	Odsesovalni nastavek, model DX08	DHR280		
199585-2	Odsesovalni nastavek, model DX09	DHR283		
199586-0	Posoda za prah za DX15	HR007G		
199595-9	Posoda za prah za DX05	DX05		
199596-7	HEPA filter DX05	DX05		
199660-4	Odsesovalni nastavek, model DX05	HR182D		
199977-5	Posoda za prah za DX01	DX01		
331886-4	Omejilnik globine	HR2600, HR2610, HR2611		
421342-3	Kapica za zbiranje prahu	Ø 6 - 14,5 mm		
421384-7	Protiprašno tesnilo	DHR261, HR2020, HR2432, HR2440, HR2440F, HR2440X, HR2450, HR2450F, HR2450T, HR2470, HR2810, HR2811		
421664-1	Kapica za zbiranje prahu 120 mm	Ø 12 - 16 mm		

[Nadaljevanje...](#)

- Akumulat orji in polnilniki
- Pribor za akumulat orske orodje
- Akumulat orske svetilke in pribor
- Pribor za laserske merilnike
- Pribor za rušenje in vrtanje**
- Pribor za vrtanje
- Kronске žage
- Pribor za vijačenje
- Pribor za rezanje in brušenje
- Pribor za poliranje in brušenje
- Pribor za rezkanje in oblanje
- Pribor za multitfunkcijsko orodje
- Pribor za žaganje
- Pribor za žebjalnike in spenjalnike
- Pribor za fene
- Pribor za sesanje
- Pribor orodja za uporabo na prostem
- Pribor za čiščenje in zaščitna oprema
- Kovčki in torbe za orodje
- Ročno orodje
- Razno
- Pribor za mešanje

# Pribor za rušenje in vrtanje













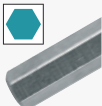
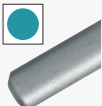

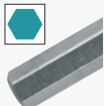

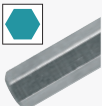
	Koda	Naziv	Za model	Cena z DDV
	421755-8	Vodoodporni pokrov	HR1830	
	423154-0	Protiprašni pokrov	HK1800, HK1810	
	P-05446	Kapica za zbiranje prahu 120 mm	HM1303, HM1400	
	P-80488	Odsesovalni nastavek	>Ø 24 mm	

# PRIBOR ZA VRTANJE

















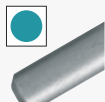

- |         |  |                               |  |
|---------|--|-------------------------------|--|
| Beton   |  | Modularna opeka               |  |
| Malta   |  | Mehki skrilavec               |  |
| Opeka   |  | Marmor                        |  |
| Apnenec |  | Granit                        |  |
|         |  | Steklo                        |  |
|         |  | Les                           |  |
|         |  | Vešana plošča                 |  |
|         |  | Keramične ploščice            |  |
|         |  | MDF                           |  |
|         |  | Mavčne plošče                 |  |
|         |  | Iverne plošče                 |  |
|         |  | Plastika, PVC                 |  |
|         |  | Steklena vlakna               |  |
|         |  | Kovine                        |  |
|         |  | Aluminij                      |  |
|         |  | Nerjavno jeklo                |  |
|         |  | Barvne kovine                 |  |
|         |  | Cilindrično vpetje            |  |
|         |  | Šestkotno vpetje              |  |
|         |  | Tristrano cilindrično vpetje  |  |
|         |  | 1/4" šestrobno vpetje         |  |
|         |  | 3/4" kvadratno vpetje         |  |
|         |  | HSS sveder                    |  |
|         |  | HM CT sveder                  |  |
|         |  | HSS-Co 5% sveder              |  |
|         |  | HSS-Co 8% sveder              |  |
|         |  | HSS-TiN sveder                |  |
|         |  | Za mokro vrtanje              |  |
|         |  | Funkcija brez udarnega vrtnja |  |
|         |  | Globoko grezenje              |  |

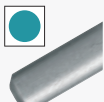
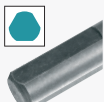

# SVEDRI ZA LES

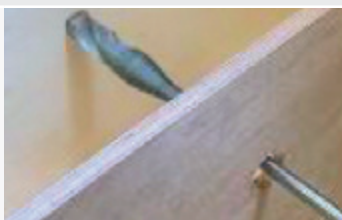
SVEDER		SPLOŠČENI SVEDRI ZA LES	SPIRALNI SVEDRI ZA LES		KAČASTI SVEDRI ZA LES		
OPIS		Primerni za vrtanje lukenj srednjega do velikega premera v mehak les ali mehko plastiko.	Najbolj razširjeni in priljubljeni za vrtanje lesa. Primerni so za vrtanje lukenj od majhnih do srednjih premerov. Z njimi lahko vrtamo mehko plastiko ali les in so zelo učinkoviti pri vrtanju čistih in natančnih lukenj.		Primerni za vrtanje globokih lukenj od srednjega do velikega premera v mehak in trd les. Konica z navojem vleče sveder v obdelovanec in tako zagotavlja hitro in enostavno vrtanje. Zelo je učinkovit za vrtanje še bolj natančnih in gladkih lukenj kot s ploščatim ali spiralnim svedrom.		
TEHNIČNI PODATKI	SERIJA	Sploščeni svedri za les	Spiralni svedri za les	Spiralni svedri za les (šestkotno vpetje)	Kačasti svedri za les (cilindrično vpetje)	Kačasti svedri za les (šestkotno vpetje)	3D kačasti svedri za les (dolgi)
	PREMER (Ø)	6 - 36 mm	3 - 20 mm	2 - 15 mm	6 - 30 mm	6 - 21 mm	6 - 30 mm
	CELOTNA DOLŽINA	150 - 160 mm	60 - 335 mm	69 - 160 mm	200 - 450 mm	200 mm	400 - 500 mm
	KONICA	Centrirna konica 	Centrirna konica 	Navojna konica 			
	VPETJE	Šestkotno 	Cilindrično 	Šestkotno 1/4" MZ 	Šestkotno 	Šestkotno 1/4" MZ 	Šestkotno 
MATERIALI	LES 	★★	★★		★★		
	LES Z ŽEBLJI 						
	VEZAN LES 		★		★		
OBDELAVA	DEBELINA 						
	SLEPA LUKNJA 		★				
AKCIJSKA SLIKA							



SVEDRI ZA OPAŽ	SAMOREZNI LESNI SVEDRI	FORSTNER SVEDRI ZA LES	NASTAVLJIV KROŽNI REZALNIK
			
<p>Zaradi svoje skupne dolžine (400 in 600 mm) se lahko uporablja na eni ali na več zaporedno postavljenih vezanih ploščah.</p>	<p>Primeren za vrtanje lukenj večjega premera za cevi v les. Navojna točka svedra zagotavlja hitro in enostavno odvajanje materiala. Primerno za vodovodne inštalacije, elektroinštalacije...</p>	<p>Primerni za vrtanje izvrtin brez trganja od srednjih do velikih premerov. Primerni za natančna dela kot je izdelava pohištva.</p>	<p>Možnost rezanja različnih materialov. Največja globina vrtanja: mavec 20 mm, vezana plošča 12 mm, MDF 12 mm, plastika 4 mm, les 20 mm. Vezana plošča in MDF morata biti tanjša od 12 mm, plastične plošče morajo biti tanjše od 4 mm.</p>
Svedri za opaž	Samorezni lesni svedri (šestkotno vpetje)	Forstner svedri za les	Nastavljiv krožni rezalnik
8 - 30 mm	25 - 76 mm	10 - 50 mm	30 - 200 mm
400 - 600 mm	127 mm	90 mm	-
<b>Dletasta konica</b>	<b>Navojna konica</b>	<b>Centrirna konica (kratka)</b>	<b>Dletasta konica</b>
			
<b>Cilindrično</b>	<b>Šestkotno 7/16"</b>	<b>Cilindrično</b>	<b>3-strano cilindrično</b>
			
★	★★	★★	★
★			
★★			★
			
		★★	
			







## Svedri za les

### Sploščeni svedri za les

Sploščeni svedri za les so primerni za vrtnanje trdega in mehkega lesa in za delo na terenu. Premeri svedrov: 6 - 36 mm za delo z visokim vrtilnim momentom.



Koda	Premer	Celotna dolžina	Vpetje
D-07674	6 mm	150 mm	CYL
D-07680	8 mm	150 mm	HEX
D-07696	10 mm	150 mm	HEX
D-07705	12 mm	150 mm	HEX
D-07711	14 mm	150 mm	HEX
D-07727	15 mm	150 mm	HEX
D-07733	16 mm	150 mm	HEX
D-07749	18 mm	150 mm	HEX
D-07755	20 mm	150 mm	HEX
D-07761	22 mm	150 mm	HEX
D-07777	24 mm	150 mm	HEX
D-07783	25 mm	150 mm	HEX
D-07799	26 mm	160 mm	HEX
D-07808	28 mm	160 mm	HEX
D-07814	30 mm	160 mm	HEX
D-07820	32 mm	160 mm	HEX
D-07836	34 mm	160 mm	HEX
D-07842	35 mm	160 mm	HEX
D-07858	36 mm	160 mm	HEX

### Spiralni svedri za les, cilindrično vpetje

Svedri so izjemno primerni za vrtnanje trdega ali mehkega lesa. Svedri imajo centrino konico in polirano zunanjo površino.



Koda	Premer	Celotna dolžina	Delovna dolžina
D-07026	3 mm	60 mm	33 mm
D-07032	4 mm	75 mm	43 mm
D-07048	5 mm	85 mm	52 mm
D-07054	6 mm	95 mm	57 mm
D-07157	6 mm	315 mm	150 mm
D-07060	7 mm	110 mm	69 mm
D-07076	8 mm	115 mm	75 mm
D-07163	8 mm	315 mm	150 mm
D-07082	9 mm	135 mm	80 mm
D-07098	10 mm	135 mm	87 mm
D-07179	10 mm	315 mm	150 mm
D-07107	12 mm	155 mm	96 mm
D-07185	12 mm	315 mm	150 mm
D-07113	14 mm	170 mm	100 mm
D-07191	14 mm	315 mm	150 mm
D-07129	16 mm	180 mm	100 mm
D-07200	16 mm	315 mm	150 mm
D-07135	18 mm	200 mm	120 mm
D-07216	18 mm	335 mm	150 mm
D-07141	20 mm	200 mm	130 mm
D-07222	20 mm	335 mm	150 mm

### Spiralni svedri za les, 1/4" vpetje



Koda	Premer	Celotna dolžina	Delovna dolžina
D-62387	2 mm	69 mm	24 mm
D-15861	3 mm	78 mm	33 mm
D-15877	4 mm	92 mm	50 mm
D-15883	5 mm	103 mm	57 mm
D-15899	6 mm	110 mm	65 mm
D-15908	8 mm	117 mm	75 mm
D-15914	10 mm	133 mm	87 mm
D-15920	12 mm	151 mm	96 mm
D-15936	15 mm	162 mm	100 mm

### Kačasti svedri za les, šestrobno vpetje

Kačasti svedri za les so najbolj primerni za vrtnanje globokih izvrtin in dosegajo odlično okroglo geometrijo luknje ter zagotavljajo hitro vrtnanje gladkih lukenj. Posebej primerni za vrtnanje trdega, mehkega, lepljenega, masivnega lesa in travov.



Koda	Premer	Celotna dolžina	Delovna dolžina
D-07238	6 mm	200 mm	130 mm
D-07331	6 mm	250 mm	180 mm
D-07244	8 mm	200 mm	130 mm
D-07347	8 mm	250 mm	180 mm
D-07434	8 mm	400 mm	330 mm
D-07559	8 mm	450 mm	380 mm
D-07250	10 mm	200 mm	130 mm
D-07353	10 mm	250 mm	180 mm
D-07440	10 mm	400 mm	330 mm
D-07565	10 mm	450 mm	380 mm
D-07266	12 mm	200 mm	130 mm
D-07369	12 mm	250 mm	180 mm
D-07456	12 mm	400 mm	330 mm
D-07571	12 mm	450 mm	380 mm
D-07272	14 mm	200 mm	130 mm
D-07375	14 mm	250 mm	180 mm
D-07462	14 mm	400 mm	330 mm
D-07587	14 mm	450 mm	380 mm
D-07288	16 mm	200 mm	130 mm
D-07381	16 mm	250 mm	180 mm
D-07478	16 mm	400 mm	330 mm
D-07593	16 mm	450 mm	380 mm
D-07294	18 mm	200 mm	130 mm
D-07397	18 mm	250 mm	180 mm
D-07484	18 mm	400 mm	330 mm
D-07602	18 mm	450 mm	380 mm
D-07303	20 mm	200 mm	130 mm
D-07406	20 mm	250 mm	180 mm
D-07490	20 mm	400 mm	330 mm
D-07618	20 mm	450 mm	380 mm
D-07319	22 mm	200 mm	130 mm
D-07412	22 mm	250 mm	180 mm
D-07509	22 mm	400 mm	330 mm
D-07624	22 mm	450 mm	380 mm
D-07325	24 mm	200 mm	130 mm

Akumulat orji in poliniki  
 Pribor za akumulat orsko orodje  
 Akumulat orske svetilke in pribor  
 Pribor za lasarske merilnike  
 Pribor za rušenje in vrtnanje  
 Pribor za vrtnanje  
 Kronske žage  
 Pribor za vijačenje  
 Pribor za rezanje in brušenje  
 Pribor za poliranje in brušenje  
 Pribor za rezkanje in oblanje  
 Pribor za multifunkcijsko orodje  
 Pribor za žaganje  
 Pribor za žebjalnike in spenjalnike  
 Pribor za fene  
 Pribor za sesanje  
 Pribor za uporabo na prostem  
 Pribor za posejale orodje in zaščitna oprema  
 Kovčki in torbe za orodje  
 Ročno orodje  
 Razno  
 Pribor za mešanje

# Pribor za vrtanje

D-07428	24 mm	250 mm	180 mm
D-07515	24 mm	400 mm	330 mm
D-07630	24 mm	450 mm	380 mm
D-07521	26 mm	400 mm	330 mm
D-07646	26 mm	450 mm	380 mm
D-07537	28 mm	400 mm	330 mm
D-07652	28 mm	450 mm	380 mm
D-07543	30 mm	400 mm	330 mm
D-07668	30 mm	450 mm	380 mm

## Kačasti svedri za les, šestrobno vpetje - dolgi

Kačasti svedri za les so najbolj primerni za vrtanje globokih izvrtin in dosegajo odlično okroglo geometrijo luknje ter zagotavljajo hitro vrtanje gladkih lukenj. Posebej primerni za vrtanje trdega, mehkega, lepljenega, masivnega lesa in tramov.



Koda	Premer	Celotna dolžina	Delovna dolžina
P-58497	8 mm	600 mm	520 mm
P-58506	10 mm	600 mm	520 mm
P-58512	12 mm	600 mm	520 mm
P-58528	14 mm	600 mm	520 mm
P-58534	16 mm	600 mm	520 mm
P-58540	18 mm	600 mm	520 mm
P-58556	20 mm	600 mm	520 mm
P-58562	22 mm	600 mm	520 mm
P-58578	24 mm	600 mm	520 mm
P-58584	26 mm	600 mm	520 mm
P-58590	28 mm	600 mm	520 mm
P-58609	30 mm	600 mm	520 mm
P-58615	32 mm	600 mm	520 mm
P-58637	36 mm	600 mm	520 mm

## Kačasti svedri za les, 1/4" vpetje

Kačasti svedri za les so najbolj primerni za vrtanje globokih izvrtin in dosegajo odlično okroglo geometrijo luknje ter zagotavljajo hitro vrtanje gladkih lukenj. Posebej primerni za vrtanje trdega, mehkega, lepljenega, masivnega lesa in tramov.



Koda	Premer	Celotna dolžina	Delovna dolžina
D-15992	6 mm	200 mm	130 mm
D-16003	8 mm	200 mm	130 mm
D-16019	10 mm	200 mm	130 mm
D-16025	12 mm	200 mm	130 mm
D-16031	14 mm	200 mm	130 mm
D-16047	16 mm	200 mm	130 mm
D-16053	18 mm	200 mm	130 mm
D-16069	20 mm	200 mm	130 mm
D-16075	21 mm	200 mm	130 mm

## Kačasti svedri za les 3D, šestrobno vpetje



Koda	Premer	Celotna dolžina	Delovna dolžina
E-07755	6 mm	400 mm	325 mm
E-07761	8 mm	400 mm	325 mm
E-07777	9 mm	400 mm	325 mm
E-07783	10 mm	400 mm	325 mm
E-07799	10,5 mm	400 mm	325 mm
E-07808	11 mm	400 mm	325 mm
E-07814	12 mm	400 mm	325 mm
E-07820	13 mm	400 mm	325 mm
E-07836	13,5 mm	400 mm	325 mm
E-07842	15 mm	400 mm	325 mm
E-07858	16 mm	400 mm	325 mm
E-07864	18 mm	400 mm	325 mm
E-07870	21 mm	400 mm	325 mm
E-07886	22 mm	400 mm	325 mm
E-07892	24 mm	400 mm	325 mm
E-07901	27 mm	400 mm	325 mm
E-07917	30 mm	400 mm	325 mm
E-07923	10,5 mm	500 mm	425 mm
E-07939	12 mm	500 mm	425 mm
E-07945	13 mm	500 mm	425 mm
E-07951	15 mm	500 mm	425 mm
E-07967	18 mm	500 mm	425 mm
E-07973	21 mm	500 mm	425 mm
E-07989	24 mm	500 mm	425 mm
E-07995	27 mm	500 mm	425 mm
E-08006	30 mm	500 mm	425 mm

## Svedri za opaž, cilindrično vpetje

Primerni za les in vezan les. Podaljšan sveder za vsestransko vrtanje v večplastne ali v gradbene sendvič materiale.

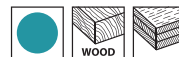

Koda	Premer	Celotna dolžina	Delovna dolžina
D-70219	8 mm	400 mm	75 mm
D-70334	8 mm	600 mm	75 mm
D-70225	10 mm	400 mm	87 mm
D-70340	10 mm	600 mm	87 mm
D-70231	12 mm	400 mm	101 mm
D-70356	12 mm	600 mm	101 mm
D-70247	14 mm	400 mm	108 mm
D-70362	14 mm	600 mm	108 mm
D-70253	16 mm	400 mm	100 mm
D-70378	16 mm	600 mm	100 mm
D-70269	18 mm	400 mm	100 mm
D-70384	18 mm	600 mm	100 mm
D-70275	20 mm	400 mm	100 mm
D-70390	20 mm	600 mm	100 mm
D-70281	22 mm	400 mm	100 mm
D-70409	22 mm	600 mm	100 mm
D-70297	24 mm	400 mm	100 mm
D-70415	24 mm	600 mm	100 mm

## Forstner svedri za les, cilindrično vpetje

Oblika zob zagotavlja kakovosten in hiter rez. Sveder je primeren za vrtanje v les, kjer so visoke zahteve kakovosti reza in kjer je potrebna natančnost pri robovih izvrtine brez trganja. Ciljna skupina uporabnikov so izdelovalci pohištva, izdelovalci zaključnih del interierja,...



Koda	Premer	Celotna dolžina	Delovna dolžina
D-41844	10 mm	90 mm	60 mm
D-41925	15 mm	90 mm	60 mm
D-42232	20 mm	90 mm	60 mm
D-42248	25 mm	90 mm	60 mm
D-42254	26 mm	90 mm	60 mm
D-42260	30 mm	90 mm	60 mm
D-42276	32 mm	90 mm	60 mm
D-42282	35 mm	90 mm	60 mm
D-42298	40 mm	90 mm	60 mm
D-42307	50 mm	90 mm	60 mm

## Samorezni svedri za les, šestrobno vpetje

Konica z navojem vleče samorezni sveder v les za hitro in agresivno vrtanje lukenj za vodovodne cevi, električno napeljavo in še kaj. Zobje na svedru hitro in natančno izrežejo točen premer luknje, oksidni premaz svedrov pa zagotavlja gladko vrtanje in enostavno odstranjevanje materiala. Z uporabo z namenskimi podaljški, uporabnik lahko doseže maksimalno globino luknje. Ob uporabi samoreznih svedrov je potrebno paziti, da se z njimi vedno vrta s priporočenim številom vrtljajev!



Koda	Premer	Celotna dolžina	Delovna dolžina
D-29935	25 mm	127 mm	80 mm
D-29957	28 mm	127 mm	80 mm
D-29963	32 mm	127 mm	80 mm
D-29979	35 mm	127 mm	80 mm
D-29985	38 mm	127 mm	80 mm
D-29991	45 mm	127 mm	80 mm
D-30003	51 mm	127 mm	80 mm
D-30019	54 mm	127 mm	80 mm
D-30025	57 mm	127 mm	80 mm
D-30031	65 mm	127 mm	80 mm
D-30047	76 mm	127 mm	80 mm
D-56518	92 mm	127 mm	80 mm
D-56524	117 mm	127 mm	80 mm

## Konice z navojem za samorezne svedre



Koda	Celotna dolžina	Primerno za
D-30156	50 mm	samorezne svedre (25-65 mm)
D-30162	70 mm	samorezne svedre (76-117 mm)

## Podaljški za samorezne svedre



Koda	Celotna dolžina	Primerno za
D-35645	140 mm	samorezne svedre
D-35651	305 mm	samorezne svedre
D-35639	457 mm	samorezne svedre

## 7-delni set samoreznih svedrov in pribora



Koda	Opis	Svedri v setu
D-36005	Podaljšek (140 mm), Majhna vijajna špica (3 kosi), Velika vijajna špica, Inbus ključ (2 kosa), Nadomestni vijak (2 kosa)	25, 32, 38, 51, 65, 76 mm

## Nastavljiv krožni izrezovalec

Možnost rezanja različnih materialov. Največja globina vrtanja: Mavec 20 mm, Vezana plošča 12 mm, MDF 12 mm, Plastika 4 mm, Les 20 mm. Vezana plošča in MDF morata biti tanjša od 12 mm, plastične plošče morajo biti tanjše od 4 mm.

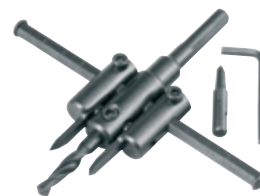

Koda	Naziv	Vpetje	Premer luknje
D-57093	Nastavljiv krožni izrezovalec	Tristrano cilindrično 10 mm	30-120 mm
D-57102	Nastavljiv krožni izrezovalec	Tristrano cilindrično 10 mm	30-200 mm
D-57118	Set rezil za krožni izrezovalec	/	/ mm

Akumulat orji in polnilniki

Pribor za akumulat orsko orodje

Akumulat orske svetilke in pribor

Pribor za lasarske merilnike

Pribor za rušenje in vrtanje

Pribor za vrtanje

Kronske žage

Pribor za vijachenje

Pribor za rezanje in brušenje

Pribor za poliranje in brušenje

Pribor za rezkanje in oblanje

Pribor za multitank orodje

Pribor za žaganje

Pribor za žebjalnike in spenjalnike

Pribor za fene

Pribor za sesanje

Pribor za orodja za uporabo na prostem

Pribor za nosenje orodja in zaščitna oprema

Kovčki in torbe za orodje

Ročno orodje

Razno

Pribor za mešanje



# PRIMERJAVA SVEDROV ZA KOVINO

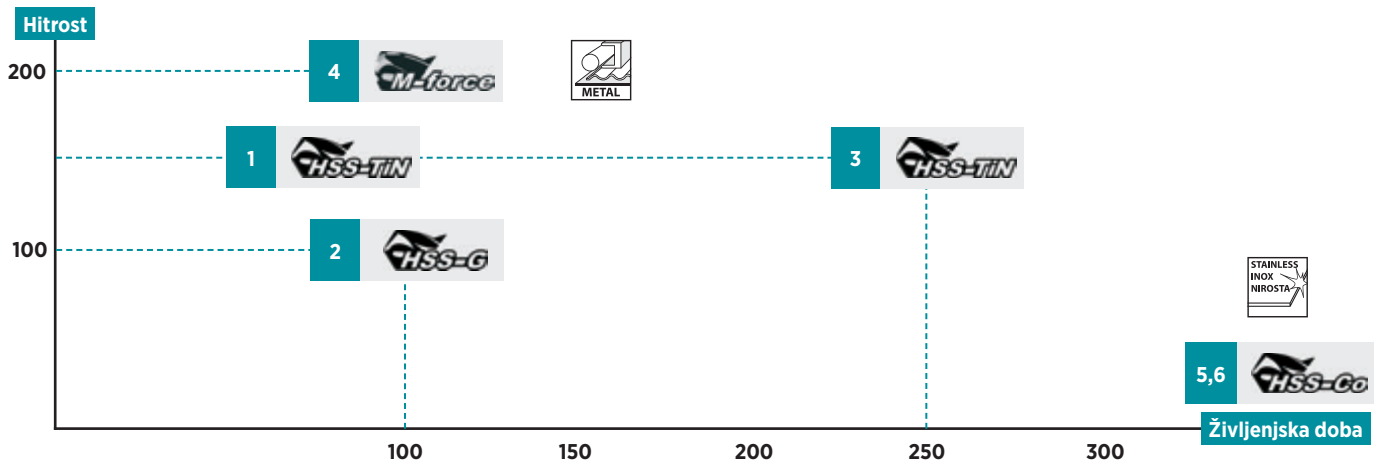

Št.	1	2	3	4	5	6
Kakovostni razred	★★	★★★	★★★★	★★★★	Specialized	Specialized
Serijska						
Opis	HSS-TiN	HSS-G	HSS-TiN Udarni vijahniki	M-force	HSS-Co5%	HSS-Co8%
Konica svadra*	Deljena konica 135° 	Rob v obliki dleta 118° 	Deljena konica 135° 	M-force oblika 	Deljena konica 135° 	Deljena konica 130° 
Površina	Titanova prevleka  Daljša življenjska doba		Titanova prevleka  Daljša življenjska doba		 Odporno na rjo	
Vpetje	Cilindrično 	Cilindrično 	Šestkotno 1/4" 	Tristrano cilindrično  Boljši oprijem kot cilindrično vpetje	Cilindrično 	Cilindrično 

AA: Priporočeno A: Sprejemljivo

Št.	1	2	3	4	5	6
Material	Les	A	A	A	A	
	Plastika	AA	AA	AA	AA	
	Barvne kovine**	AA	AA	AA	AA	A
	Jeklana pločevina	AA	AA	AA	AA	A
	Lito železo	AA	AA	AA	AA	AA
	Legirano jeklo	AA	AA	AA	AA	AA
	Nerjavno jeklo	A	A	A	A	AA

\* 135° Konica svadra: Zagotovite stabilen in hiter začetek vrtnanja.  
M-oblika: Zasnovana za gladko in hitro vrtnanje

\*\*Barvne kovine (kot so baker, nikelj in cink)

## Svedri za kovino

### Svedri HSS-G za kovino, cilindrično vpetje

Svedri so primerni za vrtnanje železnih in neželeznih zlitin in omogočajo dobre vrtnalne hitrosti in daljšo življenjsko dobo. Na voljo posamezno ali v kompletu s premeri od 1,5 do 13 mm.



Koda	Premer	Celotna dolžina	Delovna dolžina	Kos/set
D-09656	1,5 mm	40 mm	18 mm	1
D-06236	1,5 mm	40 mm	18 mm	10 / 1
D-06242	1,75 mm	46 mm	22 mm	10 / 1
D-09662	2 mm	49 mm	24 mm	1
D-06258	2 mm	49 mm	24 mm	10 / 1
D-06264	2,25 mm	53 mm	27 mm	10 / 1
D-09678	2,5 mm	57 mm	30 mm	1
D-06270	2,5 mm	57 mm	30 mm	10 / 1
D-06286	2,75 mm	61 mm	33 mm	10 / 1
D-09684	3 mm	61 mm	33 mm	1
D-06292	3 mm	61 mm	33 mm	10 / 1
D-06301	3,25 mm	65 mm	36 mm	10 / 1
D-09690	3,5 mm	70 mm	39 mm	1
D-06317	3,5 mm	70 mm	39 mm	10 / 1
D-06323	3,75 mm	70 mm	39 mm	10 / 1
D-09709	4 mm	75 mm	43 mm	1
D-06339	4 mm	75 mm	43 mm	10 / 1
D-06345	4,25 mm	75 mm	43 mm	10 / 1
D-09715	4,5 mm	80 mm	47 mm	1
D-06351	4,5 mm	80 mm	47 mm	10 / 1
D-06367	4,75 mm	80 mm	47 mm	10 / 1
D-09721	5 mm	86 mm	52 mm	1
D-06373	5 mm	86 mm	52 mm	10 / 1
D-06389	5,25 mm	86 mm	52 mm	10 / 1
D-09737	5,5 mm	93 mm	57 mm	1
D-06395	5,5 mm	93 mm	57 mm	10 / 1
D-06404	5,75 mm	93 mm	57 mm	10 / 1
D-09743	6 mm	93 mm	57 mm	1
D-06410	6 mm	93 mm	57 mm	10 / 1
D-06426	6,25 mm	101 mm	63 mm	10 / 1
D-09759	6,5 mm	101 mm	63 mm	1
D-06432	6,5 mm	101 mm	63 mm	10 / 1
D-06448	6,75 mm	109 mm	69 mm	10 / 1
D-09765	7 mm	109 mm	69 mm	1
D-06454	7 mm	109 mm	69 mm	10 / 1
D-06460	7,25 mm	109 mm	69 mm	10 / 1
D-09771	7,5 mm	109 mm	69 mm	1
D-06476	7,5 mm	109 mm	69 mm	10 / 1
D-06482	7,75 mm	117 mm	75 mm	10 / 1
D-09787	8 mm	117 mm	75 mm	1
D-06498	8 mm	117 mm	75 mm	10 / 1
D-06507	8,25 mm	117 mm	75 mm	5 / 1
D-09793	8,5 mm	117 mm	75 mm	1
D-06513	8,5 mm	117 mm	75 mm	5 / 1
D-06529	8,75 mm	125 mm	81 mm	5 / 1
D-09802	9 mm	125 mm	81 mm	1
D-06535	9 mm	125 mm	81 mm	5 / 1
D-06541	9,25 mm	125 mm	81 mm	5 / 1
D-09818	9,5 mm	125 mm	81 mm	1
D-06557	9,5 mm	125 mm	81 mm	5 / 1

D-06563	9,75 mm	133 mm	87 mm	5 / 1
D-09824	10 mm	133 mm	87 mm	1
D-06579	10 mm	133 mm	87 mm	5 / 1
D-06585	10,25 mm	133 mm	87 mm	5 / 1
D-09830	10,5 mm	133 mm	87 mm	1
D-06591	10,5 mm	133 mm	87 mm	5 / 1
D-09846	11 mm	142 mm	94 mm	1
D-06600	11 mm	142 mm	94 mm	5 / 1
D-09852	11,5 mm	142 mm	94 mm	1
D-06616	11,5 mm	142 mm	94 mm	5 / 1
D-09868	12 mm	151 mm	101 mm	1
D-06622	12 mm	151 mm	101 mm	5 / 1
D-09874	12,5 mm	151 mm	101 mm	1
D-06638	12,5 mm	151 mm	101 mm	5 / 1
D-09880	13 mm	151 mm	101 mm	1
D-06644	13 mm	151 mm	101 mm	5 / 1

### Svedri HSS-G (visoka kakovost) za kovino, tristrano cilindrično vpetje

Visokokvalitetni HSS-G svedri za profesionalno uporabo. Kot konice svedra 130° - delitev konice v skladu z DIN1412C. Primerni za rezanje jekla, legiranega in nelegiranega jekla z natezno trdnostjo < 950 N/mm<sup>2</sup>, neželeznih kovin, nerjavnega jekla in aluminija.



Koda	Premer	Celotna dolžina	Delovna dolžina	Kos/set
P-60545-10	1 mm	34 mm	13 mm	10 / 1
P-60567-10	1,5 mm	40 mm	19 mm	10 / 1
P-60589-10	2 mm	49 mm	24 mm	10 / 1
P-60604-10	2,5 mm	57 mm	32 mm	10 / 1
P-60626-10	3 mm	61 mm	34 mm	10 / 1
P-60648-10	3,5 mm	70 mm	39 mm	10 / 1
P-60660-10	4 mm	75 mm	44 mm	10 / 1
P-60682-10	4,5 mm	80 mm	47 mm	10 / 1
P-60707-10	5 mm	86 mm	51 mm	10 / 1
P-60729-10	5,5 mm	93 mm	58 mm	10 / 1
P-60741-10	6 mm	93 mm	58 mm	10 / 1
P-60763-10	6,5 mm	101 mm	63 mm	10 / 1
P-60785-10	7 mm	109 mm	69 mm	10 / 1
P-60800-10	7,5 mm	109 mm	69 mm	10 / 1
P-60822-10	8 mm	117 mm	75 mm	10 / 1
P-60844-10	8,5 mm	117 mm	75 mm	10 / 1
P-60850-10	9 mm	125 mm	80 mm	10 / 1
P-60866-10	9,5 mm	125 mm	80 mm	10 / 1
P-60872-10	10 mm	133 mm	85 mm	10 / 1
P-60888-5	10,5 mm	133 mm	85 mm	5 / 1
P-60894-5	11 mm	142 mm	89 mm	5 / 1
P-60903-5	11,5 mm	142 mm	95 mm	5 / 1
P-60919-5	12 mm	151 mm	100 mm	5 / 1
P-60925-5	12,5 mm	151 mm	100 mm	5 / 1
P-60931-5	13 mm	151 mm	100 mm	5 / 1

- Akumulat orji in polinliki
- Pribor za akumulat orske svetilke in pribor
- Pribor za laserske merilnike
- Pribor za rušenje in vrtnanje
- Pribor za vrtnanje
- Kronске žage
- Pribor za vijčanje
- Pribor za rezanje in brušenje
- Pribor za poliranje in brušenje
- Pribor za rezanje in oblanje
- Pribor za multifunkcijsko orodje
- Pribor za žaganje
- Pribor za spenjalnike
- Pribor za fene
- Pribor za sesanje
- Pribor za uporabo na prostem
- Pribor za posebej orodje za zaščita optima
- Kovčki in torbe za orodje
- Ročno orodje
- Razno
- Pribor za mešanje

# Pribor za vrtanje

## Svedri HSS-G za kovino, tristrano cilindrično vpetje - dolgi

Visokokvalitetni HSS-G svedri za profesionalno uporabo. Kot konice svedra 130° - delitev konice v skladu z DIN1412C. Primerni za rezanje jekla, legiranega in nelegiranega jekla z natezno trdnostjo < 950 N/mm<sup>2</sup>, neželeznih kovin, nerjavnega jekla in aluminija.



Koda	Premer	Celotna dolžina	Delovna dolžina	Kos/set
P-62496-10	1 mm	56 mm	33 mm	10 / 1
P-62505-10	1,5 mm	70 mm	50 mm	10 / 1
P-62511-10	2 mm	85 mm	54 mm	10 / 1
P-62527-10	2,5 mm	95 mm	61 mm	10 / 1
P-62533-10	3 mm	100 mm	67 mm	10 / 1
P-62549-10	3,5 mm	112 mm	75 mm	10 / 1
P-62555-10	4 mm	119 mm	78 mm	10 / 1
P-62561-10	4,5 mm	126 mm	81 mm	10 / 1
P-62577-10	5 mm	132 mm	87 mm	10 / 1
P-62583-10	5,5 mm	139 mm	91 mm	10 / 1
P-62599-10	6 mm	139 mm	91 mm	10 / 1
P-62608-10	6,5 mm	148 mm	97 mm	10 / 1
P-62614-10	7 mm	156 mm	102 mm	10 / 1
P-62620-10	7,5 mm	156 mm	102 mm	10 / 1
P-62636-10	8 mm	165 mm	109 mm	10 / 1
P-62642-5	8,5 mm	165 mm	109 mm	5 / 1
P-62658-5	9 mm	175 mm	115 mm	5 / 1
P-62664-5	9,5 mm	175 mm	115 mm	5 / 1
P-62670-5	10 mm	184 mm	123 mm	5 / 1
P-62686-5	10,5 mm	184 mm	123 mm	5 / 1
P-62701-5	11,5 mm	195 mm	128 mm	5 / 1
P-62717-5	12 mm	205 mm	135 mm	5 / 1
P-62723-5	12,5 mm	205 mm	135 mm	5 / 1
P-62739-5	13 mm	205 mm	135 mm	5 / 1

## Svedri HSS-Co (5%) za kovino, cilindrično vpetje

Svedri HSS so skladni s standardom DIN338 in so izdelani iz jekla M35 s 5% vsebnostjo kobalta, zaradi česar so močnejši in imajo daljšo življenjsko dobo v primerjavi z običajnimi svedri. Konica 118° zmanjšuje nevarnost zdrsa konice, obdelava pri visoki temperaturi med izdelovalnim procesom pa omogoča uporabo svedra za vrtanje jekla z visoko natezno trdnostjo ali jekla z visoko vsebnostjo zlitin (npr. ogrodje avtomobila ali letala). Uporaba za vrtanje v mehka jekla, nerjavna jekla, v materiale, ki jih je težko obdelovati, za vrtanje v varjene spoje in avtomobilske karoserije.



Koda	Premer	Celotna dolžina	Delovna dolžina	Kos/set
D-17289	1,5 mm	40 mm	18 mm	1
D-17295	2 mm	49 mm	24 mm	1
D-17304	2,5 mm	57 mm	30 mm	1
D-17310	3 mm	61 mm	33 mm	1
D-17326	3,2 mm	65 mm	36 mm	1
D-17332	3,5 mm	70 mm	39 mm	1
D-17348	4 mm	75 mm	43 mm	1
D-17354	4,5 mm	80 mm	47 mm	1
D-17360	5 mm	86 mm	52 mm	1

D-17376	5,5 mm	93 mm	57 mm	1
D-17382	6 mm	93 mm	57 mm	1
D-17398	6,5 mm	101 mm	63 mm	1
D-17407	7 mm	109 mm	69 mm	1
D-17413	7,5 mm	109 mm	69 mm	1
D-17429	8 mm	117 mm	75 mm	1
D-17435	8,5 mm	117 mm	75 mm	1
D-17441	9 mm	125 mm	81 mm	1
D-17457	9,5 mm	125 mm	81 mm	1
D-17463	10 mm	133 mm	87 mm	1
D-17479	10,5 mm	133 mm	87 mm	1
D-17485	11 mm	142 mm	94 mm	1
D-17491	11,5 mm	142 mm	94 mm	1
D-17500	12 mm	151 mm	101 mm	1
D-17516	12,5 mm	151 mm	101 mm	1
D-17522	13 mm	151 mm	101 mm	1

## Svedri HSS-Co (5%) (visoka kakovost) za kovino, cilindrično vpetje - dolgi

HSS in HSS-G svedri s kobaltnimi zlitinami. Kobalt zagotavlja boljše odpornost pri vrtanju pri visokih temperaturah. Visokokvalitetni HSS-G Co svedri s 5% kobalta so izdelani v skladu z DIN340 in so namenjeni profesionalnim uporabnikom. Kot konice svedra 130° - delitev konice v skladu z DIN1412C. Primerni za vrtanje v jekla z natezno trdnostjo < 1200 N/mm<sup>2</sup>. Primerni za vrtanje legiranega in nelegiranega jekla, nerjavnega jekla, zlitin, aluminija, aluminijevih zlitin, bakra, bronca in medenine.



Koda	Premer	Celotna dolžina	Delovna dolžina	Kos/set
P-62745-10	1 mm	56 mm	33 mm	10 / 1
P-62751-10	1,5 mm	70 mm	45 mm	10 / 1
P-62767-10	2 mm	85 mm	57 mm	10 / 1
P-62773-10	2,5 mm	95 mm	61 mm	10 / 1
P-62789-10	3 mm	100 mm	67 mm	10 / 1
P-62795-10	3,5 mm	112 mm	73 mm	10 / 1
P-62804-10	4 mm	119 mm	78 mm	10 / 1
P-62810-10	4,5 mm	126 mm	82 mm	10 / 1
P-62826-10	5 mm	132 mm	87 mm	10 / 1
P-62832-10	5,5 mm	139 mm	91 mm	10 / 1
P-62854-10	6,5 mm	148 mm	98 mm	10 / 1
P-62876-10	7,5 mm	156 mm	105 mm	10 / 1
P-62882-5	8 mm	165 mm	109 mm	5 / 1
P-62896-5	8,5 mm	165 mm	109 mm	5 / 1
P-62907-5	9 mm	175 mm	116 mm	5 / 1
P-62913-5	9,5 mm	175 mm	116 mm	5 / 1
P-62929-5	10 mm	184 mm	120 mm	5 / 1
P-62935-5	10,5 mm	184 mm	120 mm	5 / 1
P-62941-5	11 mm	195 mm	128 mm	5 / 1
P-62957-5	11,5 mm	195 mm	128 mm	5 / 1
P-62963-5	12 mm	205 mm	132 mm	5 / 1
P-62979-5	12,5 mm	205 mm	132 mm	5 / 1
P-62985-5	13 mm	205 mm	132 mm	5 / 1

## Svedri HSS-Co (8%) (visoka kakovost) za kovino, cilindrično vpetje

HSS in HSS-G svedri s kobaltnimi zlitinami. Kobalt zagotavlja boljše odpornost pri vrtanju pri visokih temperaturah. Primerni za vrtanje legiranega in nelegiranega jekla, nerjavnega jekla, zlitin, aluminija, aluminijevih zlitin, bakra, bronca in medenine. Visokokvalitetni HSS-G Co svedri z 8% kobalta so izdelani v skladu z DIN338 in so namenjeni profesionalnim uporabnikom. Kot konice svedra 130° - delitev konice v skladu z DIN1412C. Primerni za vrtanje v jekla z natezno trdnostjo < 1400 N/mm².

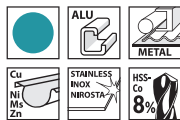

Koda	Premer	Celotna dolžina	Delovna dolžina	Kos/set
P-61846-10	1 mm	34 mm	13 mm	10 / 1
P-61868-10	1,5 mm	40 mm	19 mm	10 / 1
P-61880-10	2 mm	49 mm	24 mm	10 / 1
P-61905-10	2,5 mm	57 mm	30 mm	10 / 1
P-61927-10	3 mm	61 mm	34 mm	10 / 1
P-61949-10	3,5 mm	70 mm	39 mm	10 / 1
P-61961-10	4 mm	75 mm	44 mm	10 / 1
P-61983-10	4,5 mm	80 mm	46 mm	10 / 1
P-62000-10	5 mm	86 mm	52 mm	10 / 1
P-62022-10	5,5 mm	93 mm	57 mm	10 / 1
P-62066-10	6,5 mm	101 mm	63 mm	10 / 1
P-62088-10	7 mm	109 mm	70 mm	10 / 1
P-62094-10	7,5 mm	109 mm	70 mm	10 / 1
P-62119-10	8,5 mm	117 mm	76 mm	10 / 1
P-62125-10	9 mm	125 mm	82 mm	10 / 1
P-62131-10	9,5 mm	125 mm	82 mm	10 / 1
P-62147-10	10 mm	133 mm	87 mm	10 / 1
P-62153-5	10,5 mm	133 mm	87 mm	5 / 1
P-62169-5	11 mm	142 mm	94 mm	5 / 1
P-62175-5	11,5 mm	142 mm	94 mm	5 / 1
P-62181-5	12 mm	151 mm	100 mm	5 / 1
P-62197-5	12,5 mm	151 mm	100 mm	5 / 1
P-62206-5	13 mm	151 mm	100 mm	5 / 1

## Svedri HSS-G-TiN za kovino, cilindrično vpetje

Značilnosti in prednosti TiN (titanovega nitrida): TiN (titanov nitrid) je kemična spojina titana in dušika, ki ima dobre torne lastnosti. Zato se ta zlitina uporablja pri delih, kjer je potrebna zelo nizka obraba. Zlitino zaznamujejo naslednje lastnosti: dolga življenjska doba, visoka trdota in odpornost proti koroziji, višja hitrost vrtanja, brez sprijemanja odrezkov. Primerno za obdelavo nerjavnega jekla, legiranega in nelegiranega jekla ter zlitin. HSS-G TiN svedri v skladu z DIN338. Kot konice svedra 135° - za vrtanje jekla z natezno trdnostjo < 900 N/mm².

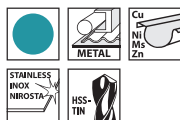

Koda	Premer	Celotna dolžina	Delovna dolžina	Kos/set
P-60981-10	1 mm	34 mm	11 mm	10 / 1
P-61008-10	1,5 mm	40 mm	19 mm	10 / 1
P-61020-10	2 mm	49 mm	23 mm	10 / 1
P-61042-10	2,5 mm	57 mm	32 mm	10 / 1
P-61064-10	3 mm	61 mm	33 mm	10 / 1
P-61086-10	3,5 mm	70 mm	39 mm	10 / 1
P-61101-10	4 mm	75 mm	43 mm	10 / 1
P-61123-10	4,5 mm	80 mm	47 mm	10 / 1
P-61145-10	5 mm	86 mm	51 mm	10 / 1

P-61167-10	5,5 mm	93 mm	57 mm	10 / 1
P-61189-10	6 mm	93 mm	57 mm	10 / 1
P-61204-10	6,5 mm	101 mm	63 mm	10 / 1
P-61226-10	7 mm	109 mm	68 mm	10 / 1
P-61248-10	7,5 mm	109 mm	68 mm	10 / 1
P-61260-10	8 mm	117 mm	74 mm	10 / 1
P-61282-10	8,5 mm	117 mm	74 mm	10 / 1
P-61298-10	9 mm	125 mm	80 mm	10 / 1
P-61307-5	9,5 mm	125 mm	80 mm	5 / 1
P-61313-10	10 mm	133 mm	86 mm	10 / 1
P-61329-5	10,5 mm	133 mm	86 mm	5 / 1
P-61335-5	11 mm	142 mm	94 mm	5 / 1
P-61341-5	11,5 mm	142 mm	94 mm	5 / 1
P-61357-5	12 mm	151 mm	101 mm	5 / 1
P-61367-5	12,5 mm	151 mm	101 mm	5 / 1
P-61379-5	13 mm	151 mm	101 mm	5 / 1

## Svedri HSS-TiN (visoka kakovost) za kovino, 1/4" vpetje



Koda	Premer	Celotna dolžina	Delovna dolžina	Kos/set
B-50893	3,2 mm	67 mm	29 mm	1
B-50918	3,5 mm	70 mm	29 mm	1
B-50924	4 mm	71 mm	30 mm	1
B-50930	4,2 mm	71 mm	31 mm	1
B-50946	4,5 mm	75 mm	31 mm	1
B-50968	5,5 mm	78 mm	35 mm	1
B-50980	6,5 mm	81 mm	38 mm	1
B-50996	7 mm	89 mm	45 mm	1
B-51007	7,5 mm	95 mm	50 mm	1
B-51029	8,5 mm	102 mm	50 mm	1
B-51035	9 mm	102 mm	50 mm	1
B-51041	10 mm	102 mm	50 mm	1
B-51057	11 mm	102 mm	50 mm	1
B-51063	12 mm	102 mm	50 mm	1
B-51079	13 mm	102 mm	50 mm	1

## Svedri HSS-TiN za kovino, 1/4" vpetje

Svedri so prevlečeni s titanovim nitridom, ki zagotavlja daljšo življenjsko dobo svedra. Šestrobno 1/4" vpetje je primerno za hitrovpeljalne glave in šestrobna vpetja. Premeri od 3 do 13 mm.



Koda	Premer	Celotna dolžina	Delovna dolžina	Kos/set
D-14928	3 mm	61 mm	33 mm	1
D-14934	3,2 mm	85 mm	36 mm	1
D-16081	3,3 mm	85 mm	36 mm	1
D-14940	4 mm	95 mm	43 mm	1
D-14956	4,2 mm	95 mm	43 mm	1
D-14962	5 mm	106 mm	52 mm	1
D-14978	6 mm	113 mm	57 mm	1

- Akumulat orji in polinliki
- Pribor za akumulat orsko svetilke in pribor
- Akumulat orske svetilke in pribor
- Pribor za lasarske merilnike
- Pribor za rušenje in vrtanje
- Pribor za vrtanje
- Kronske žage
- Pribor za vijčenje
- Pribor za rezanje in brušenje
- Pribor za poliranje in brušenje
- Pribor za rezkanje in oblanje
- Pribor za multifunkcijsko orodje
- Pribor za žaganje
- Pribor za žebjalnike in spenjalnike
- Pribor za fene
- Pribor za sesanje
- Pribor za uporabo na prostem
- Pribor za nošenje in zaščitna oprema
- Kovčki in orodje
- Ročno orodje
- Razno
- Pribor za mešanje



# Pribor za vrtanje

D-15827	8 mm	117 mm	75 mm	1
D-15833	10 mm	133 mm	87 mm	1
D-15849	12 mm	151 mm	101 mm	1
D-15855	13 mm	151 mm	101 mm	1

## Svedri za zakovice, 1/4" vpetje

Sveder za povrtavanje omogoča delo v tesnih in težko dostopnih prostorih. Primerno za: monterje klimatskih naprav, vodovodarje, oblikovalce pločevine...



Koda	Premer	Dolžina	Vpenjalo orodja	Kos/set
B-56437	3,3 mm	50 mm	1/4" MZ	10 / 1

## Stopenjski stožčasti svedri HSS-G s spiralnim utorom



Koda	Premer	Primerno za
P-69892	4-12 mm	nelegirano jeklo, nerjavno jeklo, aluminij, lito železo, jeklo < 800 N/mm <sup>2</sup> natezne trdnosti
P-69901	4-20 mm	
P-69917	4-30 mm	

## Stopenjski stožčasti svedri HSS-Co-TiALN s spiralnim utorom

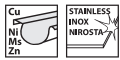

Koda	Premer	Primerno za
P-69967	4-12 mm	nelegirano jeklo, nerjavno jeklo, aluminij, lito železo, jeklo < 1.400 N/mm <sup>2</sup> natezne trdnosti
P-69973	4-20 mm	
P-69989	4-30 mm	

## HSS grezila



Koda	Premer	Grezenje	Tip vijaka
P-73514	4,3 mm	90 °	M2
P-73520	5,3 mm	90 °	M2.5
P-73536	6,3 mm	90 °	M3
P-73542	8,3 mm	90 °	M4
P-73558	9,4 mm	90 °	M4.5
P-73564	10,4 mm	90 °	M5
P-73570	12,4 mm	90 °	M6
P-73586	16,5 mm	90 °	M8

## HSS-Co grezila

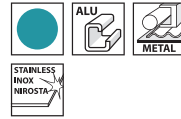

Koda	Premer	Grezenje	Tip vijaka
P-73601	6,3 mm	90 °	M3
P-73617	8,3 mm	90 °	M4
P-73623	10,4 mm	90 °	M5
P-73639	12,4 mm	90 °	M6
P-73645	16,5 mm	90 °	M8

## 6-delni set HSS grezil v kovinskem kovčku

Običajno grezilo s cilindričnim vpetjem. Grezilo s tremi rezili in velikimi utori za odvajanje materiala se uporablja za globoko grezenje.

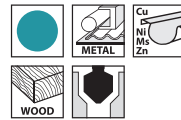

Koda	Vpetje	Grezila
D-42204	5,6,8,10 mm	6,3x45 mm (M3), 8,3x50 mm (M4), 10,4x50 mm (M5), 12,4x56 mm (M6), 16,5x60 mm (M8), 20,5x63 mm (M10)

## Svedri za opeko

### Svedri za opeko, cilindrično vpetje

Pomembnost natančne in okrogle izvrtine? Izvrtina ni samo luknja. Tradicionalni svedri se pri vrtanju premikajo, kar ustvarja trikotno luknjo, ki je večja od želene. Karkoli boste pritrčili v tako luknjo, ne bo tako trdno, kot bi moralo biti. Ko vrtate luknje za sidra morate uporabljati svedre, ki lahko naredijo natančno in okroglo izvrtino.



Koda	Premer	Celotna dolžina	Delovna dolžina
D-05234	4 mm	70 mm	35 mm
D-05240	5 mm	85 mm	45 mm
D-05256	6 mm	100 mm	60 mm
D-05262	6 mm	150 mm	90 mm
D-05290	8 mm	110 mm	60 mm
D-05309	8 mm	150 mm	90 mm
D-05321	10 mm	150 mm	90 mm
D-05343	12 mm	150 mm	90 mm
D-17728	12 mm	600 mm	505 mm
D-05359	13 mm	150 mm	85 mm
D-05365	14 mm	150 mm	85 mm
D-05371	15 mm	150 mm	85 mm
D-17734	16 mm	600 mm	505 mm

## Svedri za opeko (visoka kakovost), cilindrično vpetje

Profesionalni svedri za opeko so odporni proti udarcem in imajo HM rezalni rob v skladu z DIN8039. Primerni so za vrtanje v naravni kamen, zidane stene in beton. Kot konice 130°.

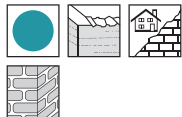

Koda	Premer	Celotna dolžina	Delovna dolžina
P-59592	3 mm	60 mm	35 mm
P-59601	4 mm	75 mm	45 mm
P-59617	5 mm	85 mm	50 mm
P-59623	6 mm	100 mm	60 mm
P-59798	6 mm	400 mm	220 mm
P-59639	7 mm	100 mm	60 mm
P-59645	8 mm	120 mm	80 mm
P-59760	8 mm	200 mm	130 mm
P-59807	8 mm	400 mm	220 mm
P-59651	9 mm	120 mm	80 mm
P-59667	10 mm	120 mm	80 mm
P-59776	10 mm	200 mm	140 mm
P-59813	10 mm	400 mm	220 mm
P-59673	11 mm	150 mm	90 mm
P-59782	12 mm	200 mm	140 mm
P-59829	12 mm	400 mm	230 mm
P-59922	12 mm	600 mm	550 mm
P-59695	13 mm	150 mm	90 mm
P-59835	14 mm	400 mm	350 mm
P-59710	16 mm	150 mm	90 mm
P-59841	16 mm	400 mm	350 mm
P-59944	16 mm	600 mm	540 mm
P-59726	18 mm	160 mm	100 mm
P-59857	18 mm	400 mm	350 mm
P-59950	18 mm	600 mm	550 mm
P-59732	20 mm	160 mm	110 mm
P-59863	20 mm	400 mm	330 mm
P-59966	20 mm	600 mm	550 mm
P-59748	22 mm	160 mm	110 mm
P-59879	22 mm	400 mm	350 mm
P-59885	25 mm	400 mm	330 mm

## Svedri večnamenski

### Svedri večnamenski, cilindrično vpetje ★★★

Konica iz volframovega karbida. Primerni za različne materiale.

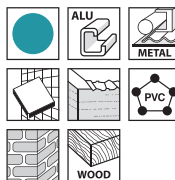

Koda	Premer	Celotna dolžina	Delovna dolžina
E-10958	3 mm	70 mm	38 mm
E-10964	4 mm	75 mm	40 mm
E-10970	5 mm	85 mm	43 mm
E-10986	5.5 mm	100 mm	50 mm
E-10992	6 mm	100 mm	50 mm
E-11003	6 mm	150 mm	90 mm
E-11019	6.5 mm	100 mm	50 mm
E-11025	6.5 mm	150 mm	90 mm
E-11031	7 mm	100 mm	50 mm
E-11047	8 mm	120 mm	60 mm
E-11053	8 mm	150 mm	90 mm
E-11069	10 mm	150 mm	90 mm
E-11075	12 mm	150 mm	90 mm
E-11081	13 mm	150 mm	90 mm

### Svedri večnamenski, cilindrično vpetje ★★

Konica iz volframovega karbida. Primerni za različne materiale. Ni primerno za obdelavo aluminija, ko je konica obrabljena. Za obdelavo aluminija vedno uporabljajte nove svedre.

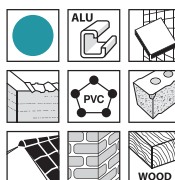

Koda	Premer	Celotna dolžina	Delovna dolžina
D-71875	3 mm	60 mm	28 mm
D-71881	4 mm	70 mm	35 mm
D-71897	5 mm	85 mm	43 mm
D-71906	6 mm	100 mm	58 mm
D-71912	6 mm	150 mm	108 mm
D-71928	8 mm	110 mm	57 mm
D-71934	8 mm	150 mm	97 mm
D-71940	10 mm	150 mm	97 mm

## Svedri za steklo

### Svedri za steklo, 1/4" vpetje

Makita svedri za vrtanje v steklo imajo konico v obliki puščice, ki omogoča lažje vrtanje v steklo in keramiko. Svedri so idealni za dela v kuhinji ali kopalnici.



Koda	Premer	Celotna dolžina	Delovna dolžina
D-15942	4 mm	65 mm	/
D-15958	5 mm	65 mm	/
D-15964	6 mm	65 mm	/
D-15970	8 mm	70 mm	/
D-15986	10 mm	80 mm	/

Akumulat orji in polnilniki  
 Pribor za akumulat orske svetilke in pribor  
 Akumulat orske svetilke in pribor  
 Pribor za laserske merilnike  
 Pribor za rušenje in vrtanje  
 Pribor za vrtanje  
 Kronske žage  
 Pribor za vijachenje  
 Pribor za rezanje in brušenje  
 Pribor za poliranje in brušenje  
 Pribor za rezkanje in oblanje  
 Pribor za multifunkcijsko orodje  
 Pribor za zaganje  
 Pribor za zebjalnike in spenjalnike  
 Pribor za fene  
 Pribor za sesanje  
 Pribor orodja za uporabo na prostem  
 Pribor za nošenje in zaščita optena  
 Kovčki in orodje  
 Ročno orodje  
 Razno  
 Pribor za mešanje

# Pribor za vrtanje

## Nastavki za vrtanje in vijačenje

Nastavki za vrtanje, grezenje in vijačenje v enem. Nastavki imajo vijak za prilagoditev globine vrtanja.

### Nastavki za vrtanje in vijačenje



Koda	Velikost povrtala	Premer svedra	Globina vrtanja	Vijačni nastavek
D-73209	Št. 6 (M3)	2,4 mm	11 - 31 mm	PH2
D-73215	Št. 8 (M4)	2,8 mm	18 - 38 mm	PH2
D-73221	Št. 10 (M5)	3,2 mm	22 - 41 mm	PH2

### Rezervna grezila s svedri



Koda	Velikost povrtala	Premer svedra	Globina vrtanja	Za model
D-73237	Št. 6 (M3)	2,4 mm	11 - 31 mm	D-73209
D-73243	Št. 8 (M4)	2,8 mm	18 - 38 mm	D-73215
D-73259	Št. 10 (M5)	3,2 mm	22 - 41 mm	D-73221

### 4-delni set grezil s svedrom

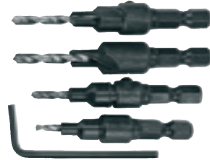

Koda	Velikost povrtala	Premer svedra	Globina vrtanja
D-73455	Št. 6 (M3)	2,4 mm	11 - 31 mm
	Št. 8 (M4)	2,8 mm	18 - 38 mm
	Št. 10 (M5)	3,2 mm	22 - 41 mm
	Št. 12 (M6)	3,6 mm	26 - 45 mm

## Pribor za diamantne vrtalnike

### Diamantne vrtalne krome za mokro vrtanje



Koda	Premer	Globina vrtanja	Vpetje
P-65816	62 mm	400 mm	UNC 5/4"
P-41090	92 mm	400 mm	UNC 5/4"
P-41115	102 mm	400 mm	UNC 5/4"
P-41143	112 mm	400 mm	UNC 5/4"
P-41159	117 mm	400 mm	UNC 5/4"
P-65822	122 mm	400 mm	UNC 5/4"

P-65838	132 mm	400 mm	UNC 5/4"
P-41171	152 mm	400 mm	UNC 5/4"
P-41187	162 mm	400 mm	UNC 5/4"
P-41202	182 mm	400 mm	UNC 5/4"
P-41224	212 mm	400 mm	UNC 5/4"
P-41230	225 mm	400 mm	UNC 5/4"

### Adapterji in podaljški

Koda	Opis	Slika
P-14015	Adapter z 5/4" na M30 za model DBM230	
P-41626	Podaljšek za diamantne krome 300 mm za model DBM230	

### Stojala in pribor

Koda	Opis	Slika
P-40082	Stojalo za vrtalno napravo za model DBM130, DBM131	
P-54190	Stojalo za vrtalno napravo za model DBM230	
P-54178	Nastavek za odsesovanje vode za model DBM230	
P-54184	Tesnilo nastavka za model DBM230	
P-40098	Pritrdilni nastavek za stojalo P-54190	
P-54221	Vakuumski set stojala P-54190	

## Vrtalne krone za magnetne vrtalnike

### Vrtalne krone, 19 mm Weldon vpetje



Koda	Premer	Delovna dolžina	Za model
HB-13S	13 mm	25 mm	HB500, HB350
HB-14S	14 mm	25 mm	HB500, HB350
HB-15S	15 mm	25 mm	HB500, HB350
HB-16S	16 mm	25 mm	HB500, HB350
HB-17S	17 mm	25 mm	HB500, HB350
HB-18S	18 mm	25 mm	HB500, HB350
HB-19S	19 mm	25 mm	HB500, HB350
HB-20S	20 mm	25 mm	HB500, HB350
HB-22S	22 mm	25 mm	HB500, HB350
HB-24S	24 mm	25 mm	HB500, HB350
HB-25S	25 mm	25 mm	HB500, HB350
HB-26S	26 mm	25 mm	HB500, HB350
HB-28S	28 mm	25 mm	HB500, HB350
HB-30S	30 mm	25 mm	HB500, HB350
HB-32S	32 mm	25 mm	HB500, HB350
HB-20L	20 mm	50 mm	HB500
HB-22L	22 mm	50 mm	HB500
HB-24L	24 mm	50 mm	HB500
HB-28L	28 mm	50 mm	HB500
HB-30L	30 mm	50 mm	HB500
HB-32L	32 mm	50 mm	HB500
HB-34L	34 mm	50 mm	HB500
HB-35L	35 mm	50 mm	HB500
HB-36L	36 mm	50 mm	HB500
HB-42L	42 mm	50 mm	HB500
HB-45L	45 mm	50 mm	HB500
HB-50L	50 mm	50 mm	HB500

### Centrirni nastavki za vrtalne krone



Koda	Premer	Delovna dolžina	Za model
HB-PILOTS	/ mm	25 mm	HB500, HB350
HB-PIOTL	/ mm	50 mm	HB500

## Svedri za zemljo za udarne vijačnike

### Svedri za zemljo



Koda	Premer	Celotna dolžina	Delovna dolžina	Vpetje
B-54346	20 mm	600 mm	530 mm	3/4" kvadratno vpetje
B-54352	25 mm	600 mm	530 mm	3/4" kvadratno vpetje
B-54368	30 mm	600 mm	530 mm	3/4" kvadratno vpetje
B-54374	35 mm	600 mm	530 mm	3/4" kvadratno vpetje
B-57576*	40 mm	600 mm	530 mm	3/4" kvadratno vpetje
B-57582	40 mm	600 mm	530 mm	3/4" kvadratno vpetje

\* Vključen natični ključ, tesnilo in zatič

### Pribor za svedre za zemljo

Koda	Opis	Slika
B-54380	Natični ključ za sveder za zemljo, 3/4" kvadratno vpetje	
B-54396	Zatič za natični ključ B-54380	
B-54405	O-tesnilo za natični ključ B-54380	

## Svedri za zemljo za vrtalnike-vijačnike

### Svedri za zemljo

Obvezna uporaba z modeli s stranskim ročajem.



Koda	Premer	Celotna dolžina	Delovna dolžina	Vpetje
D-75415	30 mm	600 mm	200 mm	11,8 mm HEX
D-75421	45 mm	600 mm	200 mm	11,8 mm HEX
D-75437	70 mm	600 mm	200 mm	11,8 mm HEX

Akumulat orji in polnilniki

Pribor za akumulat orsko orodje

Akumulat orske svetilke in pribor

Pribor za lasarske merilnike

Pribor za rušenje in vrtanje

Pribor za vrtanje

Kronske žage

Pribor za vijčenje

Pribor za rezanje in brušenje

Pribor za poliranje in brušenje

Pribor za rezkanje in oblanje

Pribor za multifunkcijsko orodje

Pribor za žaganje

Pribor za žebjalnike in spenjalnike

Pribor za fene

Pribor za sesanje

Pribor za orodja za uporabo na prostem

Pribor za ročno orodje za zaščito oprema

Kovčki in torbe za orodje

Ročno orodje

Razno

Pribor za mešanje



## Vrtalne glave

## Hitrovpjenjalne vrtalne glave

	Koda	Razpon vpenjalne glave (mm)	Velikost navoja	Za model	Cena z DDV
	193203-4	0,5-6,5	3/8"-24 UNF	6501, 6501X, DP2010, DP2011	
	196309-7	0,8-10	1/2"-20 UNF	DDF343, DHP343, 6281,6271, 6261	
	763181-8	0,8-10	1/2"-20 UNF	MT064	
	763187-6	0,8-10	1/2"-20 UNF	6260D, 6270D, 6280D, 6207D, 8270D, 8280D, 8270DW	
	763228-8	0,8-10	3/8"-24 UNF	DF330D, HP330D, DDA341, DDA351, DF331D, HP331D	
	763229-6	0,8-10	1/2"-20 UNF	8291, 8281, 8271, BHP343, DHP343, HP330D, HP331D, HP347D	
	766009-9	0,8-10	1/2"-20 UNF	6207DWDE	
	766012-0	0,8-10	1/2"-20 UNF	MT080, DF0300, HP0300	
	766013-8	1 - 13	1/2"-20 UNF	MT081E	
	192284-5	1,5-13	1/2"-20 UNF	6211D, 6311D	
	192685-7	1,5-13	1/2"-20 UNF	HP2041	
	194254-0	1,5-13	1/2"-20 UNF	HP2051, HP2051H, HP2071, DP4011, HB500	

[Nadaljevanje...](#)



# Pribor za vrtnanje

Koda	Razpon vpenjalne glave (mm)	Velikost navoja	Za model	Cena z DDV	
196193-0	1,5-13	1/2"-20 UNF	HP1631, HP1641		
196306-3	1,5-13	1/2"-20 UNF	DDF453, DHP453, DF457D, HP457D, 6391, 8391, 6381, 8381		
763158-3	1,5-13	1/2"-20 UNF	DP4001, DP4003, DP4700, 6317, 6337, 6347		
763178-7	1,5-13	1/2"-20 UNF	6390D, 8390D		
763191-5	1,5-13	1/2"-20 UNF	DHP451, DHP454		
763196-5	1,5-13	1/2"-20 UNF	DDF451, DHP451, DDF441, DHP44, DDF444, DDF454, DHP444, DHP454		
763248-2	1,5-13	1/2"-20 UNF	DDF448, DDF458, DDF481, DHP448, DHP458, DHP481		
763256-3	1,5-13	1/2"-20 UNF	DDF484, DHP482, DF002G, HP002G		
766019-6	1,5-13	1/2"-20 UNF	MT818, M8104		
766027-7	1,5-13	1/2"-20 UNF	DDF446, DDF456, DHP484, DHP485		
P-15718	1,5-13	1/2"-20 UNF	6013B, 6013BR, 6300-4, DP4001, DP4003, DP4700, HP1620-HP1621K, HP2050-HP2051F, HP2070-HP2071F		
196307-1	10	1/2"-20 UNF	6260, 6270, 6280D		
193226-2	1-10	1/2"-20 UNF	DP3003		

[Nadaljevanje...](#)

- Akumulat orji in polnilniki
- Pribor za akumulat orsko orodje
- Akumulat orske svetilke in pribor
- Pribor za lasarske merilnike
- Pribor za rušenje in vrtnanje
- Pribor za vrtnanje
- Kronske žage
- Pribor za vijačenje
- Pribor za rezanje in brušenje
- Pribor za poliranje in brušenje
- Pribor za rezkanje in oblanje
- Pribor za multitfunkcijsko orodje
- Pribor za žaganje
- Pribor za žebjalnike in spenjalnike
- Pribor za fene
- Pribor za sesanje
- Pribor za uporabo na prostem
- Pribor za čiščenje orodja in zaščitna oprema
- Kovčki in torbe za orodje
- Ročno orodje
- Razno
- Pribor za mešanje

# Pribor za vrtanje

	Koda	Razpon vpenjalne glave (mm)	Velikost navoja	Za model	Cena z DDV
	766026-9	1-10	3/8"-24 UNF	MT607, M6002	
	193064-2	1-13	1/2"-20 UNF	DDF460, DHP460	

## Vrtalne glave z zobatim vencem







	Koda	Razpon vpenjalne glave (mm)	Vpetje	Za model	Cena z DDV
	P-04313	0,5-10	3/8"-24 UNF	6408, 6410, 6510LVR	
	192887-5	0,5-6,5	3/8"-24 UNF	6501, DP2010	
	192879-4	1,5-10	3/8"-24 UNF	6510PB	
	763174-5	1,5-10	1/2"-20UNF	DA3010, DDA350, DDA340	
	192883-3	1,5-13	5/8"-16 UNF	DA6301	
	766016-2	1,5-13	1/2"-20 UNF	HP1630, HP1640	
	193822-6	1-13	1/2"-20UNF	DS4010, DS4011, HP2050, HP2070, HB500, 6300-4, DP4700	
	192877-8	2-13	1/2"-20 UNF	6305	
	193318-7	2-13	Glava s vratilom	DA4000LR	

# Pribor za vrtnje

## Vrtalne glave, 1/4" vpetje

Koda	Razpon vpenjalne glave (mm)	Vpetje	Za model	Cena z DDV	
192075-4	0,5-10	1/4" (6,35 mm) ISO	BTP, DTP, BTD, DTD, TD		



## Pribor za vrtalne glave

Koda	Naziv	Za model	Cena z DDV	
410102-8	Držalo ključa za vrtalno glavo	763430-3, 763432-9		
411780-7	Držalo ključa za vrtalno glavo	763418-3, 763415-9		
418163-2	Držalo ključa za vrtalno glavo	763441-8, 763418-3		
763415-9	Ključ za vrtalno glavo	763174-5		
763418-3	Ključ za vrtalno glavo	192887-5		
763432-9	Ključ za vrtalno glavo	P-04329, 192877-8, 192883-3, 193318-7		

- Akumulat orji in polnilniki
- Pribor za akumulat orske svetilke in pribor
- Akumulat orske svetilke in pribor
- Pribor za lasarske merilnike
- Pribor za rušenje in vrtnje
- Pribor za vrtnje
- Kronske žage
- Pribor za vijačenje
- Pribor za rezanje in brušenje
- Pribor za poliranje in brušenje
- Pribor za rezkanje in oblanje
- Pribor za multitank cjsko orodje
- Pribor za žaganje
- Pribor za žebjalnike in spenjalnike
- Pribor za fene
- Pribor za sesanje
- Pribor orodja za uporabo na prostem
- Pribor za nožne orodja in zaščitna oprema
- Kovčki in torbe za orodje
- Ročno orodje
- Razno
- Pribor za mešanje

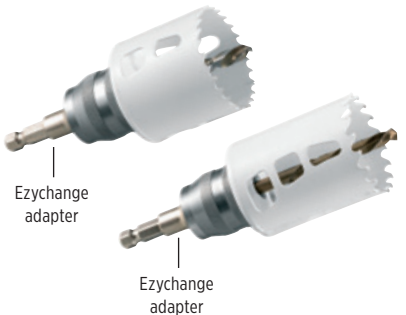
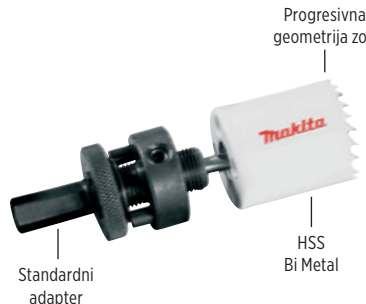
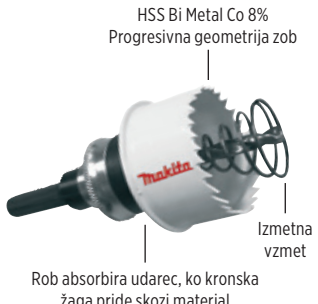
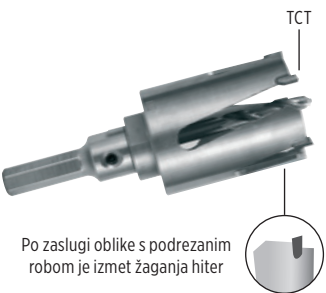

# KRONSKÉ ŽAGE

<p><b>Ezychange</b> Bi-Metal HSS 8%Co</p> <p><b>Ezychange</b> TCT</p>	<p>Kronske žage Bi-Metal</p>	<p>Kronske žage Bi-Metal za pločevino</p>
 <p>Ezychange adapter</p> <p>Ezychange adapter</p>	 <p>Standardni adapter</p> <p>HSS Bi Metal</p> <p>Progresivna geometrija zob</p>	 <p>HSS Bi Metal Co 8% Progresivna geometrija zob</p> <p>Izmetna vzmet</p> <p>Rob absorbira udarec, ko kronska žaga pride skozi material</p>
<p>Večnamenske TCT kronske žage</p>	<p>Kronske žage z robom iz volframovega karbida</p>	<p>Diamantne kronske žage za mokro vrtnje v trdo keramiko</p>
 <p>TCT</p> <p>Po zaslugi oblike s podreznim robom je izmet žaganja hiter</p>	 <p>Standardni adapter</p> <p>Številna velika zrna (#20-30) omogočajo hitro in gladko vrtnje</p>	 <p>Standardni adapter</p> <p>Diamantna zrna omogočajo hitro vrtnje in daljšo življenjsko dobo</p>



Primerno		Kovina	Nerjavno jeklo	Aluminij	Barvne kovine	Les	MDF	Mavčne plošče	Plastika	Steklena vlakna	Keramične plošče	Opeka	Apnec	Marmor	Granit
Bim	<b>Ezychange</b> Bi-Metal HSS 8%Co	★★	★	★★		★★			★★						
	Bi-Metal	★★		★	★	★★			★★						
	Bi-Metal za pločevino	★★	★★		★										
Volframov karbid	<b>Ezychange</b> TCT	★★	★★			★★			★★		★	★			
	Večnamenske TCT					★★	★★	★★	★★	★★	★		★		
	Z robom iz volframovega karbida										★★	★★			
Diamantne	Za mokro vrtnje v trdo keramiko										★★			★★	★★

★★: Priporočljivo ★: Ustrezno

## EZYCHANGE KRONSKE ŽAGE

# Ezychange

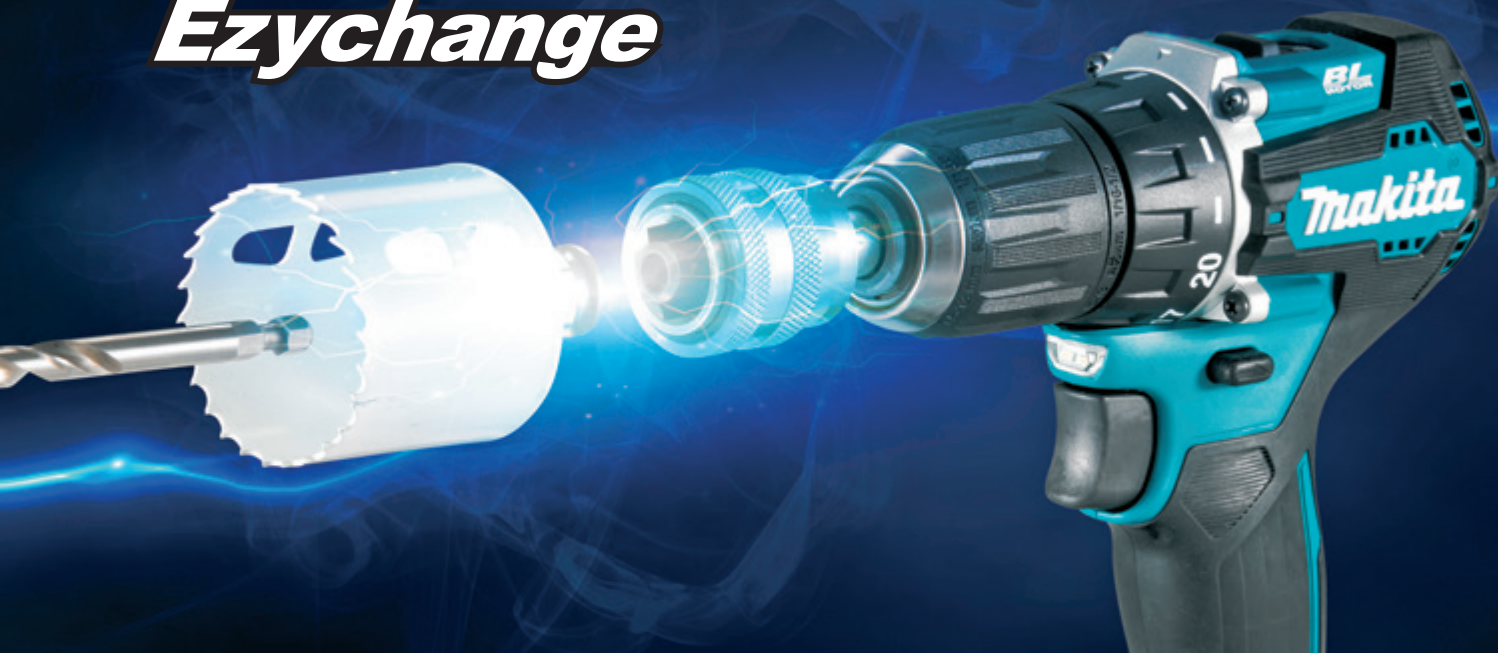

### LE EN KLIK ZA ZAMENJAVO KRONSKE ŽAGE

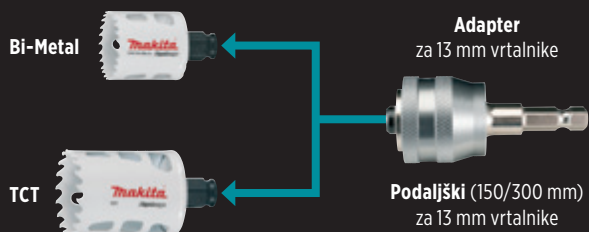

### ENOSTAVNO ODSTRANJEVANJE PRAHU S SVEDROM



## Ezychange Bi-Metal HSS 8%Co

Progresivna geometrija zob za hitrejše rezanje.

Z globino rezanja 44 mm lahko uporabnik z gotovostjo reže v 38 mm material.



Omogoča rezanje v nerjaveče jeklo debeline 3 mm.

## Ezychange TCT

TCT zobje za večjo vzdržljivost.

60 mm delovna dolžina za rezanje lukenj v 5x10 letve z enim prehodom. Možno tudi rezanje lukenj v WPC (kompozitne les-plastika) letve.



Omogoča rezanje v nerjaveče jeklo debeline 3 mm in večji nabor drugih materialov v primerjavi z BiM.

## Kronske žage Ezychange Bi-Metal HSS 8%Co



## Kronske žage Ezychange Bi-Metal HSS 8%Co

Na eno držalo za kronske žage s hitrozamenljivim centrirnim svodom je možno pritrditi kronske žage s premeri od 16 do 152 mm. To ne omogoča le hitre menjave kronske žage, ampak tudi varnejšo uporabo. Izdelane so iz HSS Bi-Metal jekla z 8% kobalta. Primerne so za rezanje železnih in neželeznih materialov, nerjavnega jekla, aluminija, lesa in plastike.





Koda	Premer (Ø) (mm)	Globina vrtanja (mm)	Število obratov - kovine (min <sup>-1</sup> )	Število obratov - nerjavno jeklo (min <sup>-1</sup> )	Število obratov - aluminij (min <sup>-1</sup> )	Število obratov - les (min <sup>-1</sup> )	Število obratov - plastika (min <sup>-1</sup> )	Cena z DDV
E-03632	16	44	530	275	825	3.000	3.000	
E-03648	17	44	500	250	750	3.000	3.000	
E-03654	19	44	460	230	690	3.000	3.000	
E-03660	20	44	440	220	675	3.000	3.000	
E-03676	22	44	390	195	580	3.000	3.000	
E-03682	24	44	370	185	555	2.700	2.700	
E-03698	25	44	350	175	525	2.700	2.700	
E-03707	27	44	325	160	480	2.700	2.700	
E-03713	29	44	300	150	450	2.700	2.700	
E-03729	30	44	285	145	425	2.400	2.400	
E-03735	32	44	275	140	410	2.400	2.400	
E-03741	35	44	250	125	375	2.400	2.400	
E-03757	37	44	240	120	360	2.400	2.400	
E-03763	38	44	230	115	345	2.400	2.400	
E-03779	40	44	220	110	330	2.100	2.100	
E-03785	41	44	210	105	315	2.100	2.100	
E-03791	44	44	195	95	295	2.100	2.100	
E-03800	46	44	190	95	285	2.100	2.100	
E-03816	48	44	180	90	270	2.100	2.100	
E-03822	51	44	170	85	255	2.000	2.000	
E-03838	52	44	165	80	240	2.000	2.000	
E-03844	54	44	160	80	240	2.000	2.000	
E-03850	56	44	155	80	240	2.000	2.000	
E-03866	57	44	150	75	225	2.000	2.000	
E-03872	60	44	140	70	220	2.000	2.000	
E-03888	64	44	135	65	205	1.850	1.850	
E-03894	65	44	130	65	200	1.850	1.850	
E-03903	68	44	130	65	190	1.800	1.800	
E-03919	70	44	125	60	185	1.800	1.800	
E-03925	73	44	120	60	180	1.800	1.800	
E-03931	76	44	115	55	170	1.800	1.800	
E-03947	79	44	110	55	165	1.500	1.500	
E-03953	83	44	105	50	155	1.500	1.500	
E-03969	86	44	100	50	150	1.500	1.500	
E-03975	92	44	90	45	140	1.200	1.200	
E-03981	95	44	90	45	135	1.200	1.200	
E-03997	102	44	85	40	130	1.000	1.000	
E-04008	105	44	80	40	120	1.000	1.000	
E-04014	111	44	80	40	120	900	900	
E-04020	114	44	75	35	105	900	900	
E-04036	121	44	75	35	95	900	900	
E-04042	127	44	65	30	90	800	800	

[Nadaljevanje...](#)

# Kronske žage

Koda	Premer (Ø) (mm)	Globina vrtanja (mm)	Število obratov - kovine (min <sup>-1</sup> )	Število obratov - nerjavno jeklo (min <sup>-1</sup> )	Število obratov - aluminij (min <sup>-1</sup> )	Število obratov - les (min <sup>-1</sup> )	Število obratov - plastika (min <sup>-1</sup> )	Cena z DDV
E-04058	140	44	60	25	85	800	800	
E-04064	152	44	55	25	75	800	800	

## Pribor za kronske žage Ezychange Bi-Metal HSS 8%Co

Koda	Naziv	Premer (Ø) (mm)	Delovna dolžina (mm)	Celotna dolžina (mm)	Šestrobno vpetje (")	Primerno za	Cena z DDV
E-04070	Ezychange adapter in HSS-G centrirni sistem	7,15	43	85	3/8	kovina, aluminij, barvne kovine	
E-04086	Srednji sveder kronske žage HSS-G 7,15x85mm	7,15	43	85	1/4	kovina, aluminij, barvne kovine	
E-04092	Srednji sveder kronske žage HSS-CO 7,15x85mm	7,15	43	85	1/4	nerjavno jeklo	

## Kronske žage Ezychange TCT



### Kronske žage Ezychange TCT

Kronske žage T.C.T. Ezychange so izjemno vzdržljive in primerne za različne materiale. Zobje žage so dodatno zaščiteni s toplotno odporno T.C.T. prevleko.

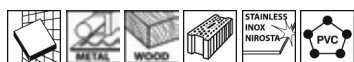







Koda	Premer (Ø) (mm)	Globina vrtanja (mm)	Število obratov - kovine (min <sup>-1</sup> )	Število obratov - nerjavno jeklo (min <sup>-1</sup> )	Število obratov - les (min <sup>-1</sup> )	Število obratov - plastika (min <sup>-1</sup> )	Število obratov - ploščice (min <sup>-1</sup> )	Število obratov - opeka (min <sup>-1</sup> )	Cena z DDV
E-06644	20	60	880	440	3.000	3.000	440	880	
E-06650	22	60	780	390	3.000	3.000	390	780	
E-06666	25	60	700	350	2.700	2.700	350	700	
E-06672	32	60	550	280	2.400	2.400	280	550	
E-06688	35	60	500	250	2.400	2.400	250	500	
E-06694	38	60	460	230	2.400	2.400	230	460	
E-06703	40	60	440	220	2.100	2.100	220	440	
E-06719	44	60	390	190	2.100	2.100	190	390	
E-06725	51	60	340	170	2.000	2.000	170	340	
E-06731	54	60	320	160	2.000	2.000	160	320	
E-06747	60	60	280	140	2.000	2.000	140	280	
E-06753	64	60	270	130	1.850	1.850	130	270	
E-06769	67	60	260	130	1.800	1.800	130	260	
E-06775	68	60	260	130	1.800	1.800	130	260	
E-06781	70	60	250	120	1.800	1.800	120	250	
E-06797	73	60	240	120	1.800	1.800	120	240	
E-06806	76	60	230	110	1.800	1.800	110	230	
E-06812	83	60	210	100	1.500	1.500	100	210	
E-06828	102	60	170	80	1.000	1.000	80	170	
E-06834	128	60	130	60	800	800	60	130	

Akumulat orji in polnilnike  
 Pribor za akumulat orsko svetilke in pribor  
 Akumulat orske svetilke in pribor  
 Pribor za lasarske merilnike  
 Pribor za rušenje in vrtanje  
 Pribor za vrtanje  
 Kronske žage  
 Pribor za vijačenje  
 Pribor za rezanje in brušenje  
 Pribor za poliranje in brušenje  
 Pribor za rezkanje in oblanje  
 Pribor za multifunkcijsko orodje  
 Pribor za žaganje  
 Pribor za žebličenje in spenjanje  
 Pribor za fene  
 Pribor za sesanje  
 Pribor orodja za uporabo na prostem  
 Pribor za ročno orodje za zaščito oprema  
 Kovčki in torbe za orodje  
 Ročno orodje  
 Razno  
 Pribor za mešanje



# Kronske žage

## Pribor za kronske žage Ezychange TCT

	Koda	Naziv	Premer (Ø) (mm)	Delovna dolžina (mm)	Celotna dolžina (mm)	Šestrobno vpetje (")	Primerno za	Cena z DDV
	E-06840	Srednji sveder kronske žage HSS-G 105mm	6,35	62	105	1/4	kovina	
	E-06856	Srednji sveder kronske žage HSS-CO 106mm	6,35	62	105	1/4	kovina	
	E-06862	Srednji sveder kronske žage TCT 105mm	6,35	50	105	1/4		
	E-06878	Podaljšek za kronske žage Ezychange 150mm	11	/	150	7/16	/	
	E-06884	Podaljšek za kronske žage Ezychange 300mm	11	/	300	7/16	/	
	E-06959	Set adapter 3/8" + TCT sveder 105mm Ezychange	8,7	50	105	3/8		

## Kronske žage HSS-Bi-Metal

### Kronske žage HSS-Bi-Metal

HSS-Bi-Metal kronske žage imajo variabilen korak zob in so primerne za rezanje jekla, aluminija, bakra, medenine, lesa in plastike. Te kronske žage so v najbolj uporabljenih velikostih vključene tudi v komplete za vodovodarje in električarje. Možnost šestrobne vpetja, klasičnega vpetja s tremi čeljustmi in SDS-Plus vpetja.







Koda	Premer (Ø) (mm)	Število obratov - jeklo (min <sup>-1</sup> )	Število obratov - kovine (min <sup>-1</sup> )	Število obratov - aluminij (min <sup>-1</sup> )	Število obratov - les (min <sup>-1</sup> )	Cena z DDV
D-16994	16	275	550	825	3.000	
D-17005	19	230	460	690	3.000	
D-17251	20	220	440	675	3.000	
D-17011	22	195	390	580	3.000	
D-17027	24	185	370	555	3.000	
D-17033	25	175	350	525	2.700	
D-17267	29	150	300	450	2.700	
D-17049	32	140	275	410	2.400	
D-17055	35	125	250	375	2.400	
D-17061	38	115	230	345	2.400	
D-17273	40	110	220	330	2.100	
D-17077	44	95	195	295	2.100	
D-17083	51	85	170	255	2.000	
D-24876	54	80	160	240	2.000	
D-17099	57	75	150	225	2.000	
D-25688	60	70	140	220	2.000	
D-24882	65	65	130	200	1.850	
D-17108	68	65	130	190	1.800	
D-25694	70	60	125	185	1.800	
D-17114	76	55	115	170	1.800	
D-33869	80	55	110	165	1.500	
D-17120	83	50	105	155	1.500	
D-17136	92	45	90	140	1.200	

Nadaljevanje...

# Kronske žage

Koda	Premer (Ø) (mm)	Število obratov - jeklo (min <sup>-1</sup> )	Število obratov - kovine (min <sup>-1</sup> )	Število obratov - aluminij (min <sup>-1</sup> )	Število obratov - les (min <sup>-1</sup> )	Cena z DDV
D-17142	105	40	80	120	1.000	
D-17158	127	30	65	90	800	
D-17164	152	25	55	75	800	

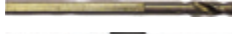
## Pribor za kronske žage HSS-Bi-Metal

Koda	Naziv	Cena z DDV	
D-17170	Adapter, 6-kotno vpetje, 16-29 mm		
D-17186	Adapter, 6-kotno vpetje, 32-152 mm		
D-17192	Centrirni sveder, 71 mm		
D-17603	Adapter SDS-Plus s svedrom, 14-29 mm		
D-17619	Adapter SDS-Plus s svedrom, 32-76 mm		

## Set kronske žage HSS-Bi-Metal

HSS-Bi-Metal kronske žage imajo variabilen korak zob in so primerne za rezanje jekla, aluminija, bakra, medenine, lesa in plastike. Te kronske žage so v najbolj uporabljenih velikostih vključene tudi v komplete za vodovodarje in električarje. Možnost šestrobnega vpetja, klasičnega vpetja s tremi čeljustmi in SDS-Plus vpetja.







Koda	Naziv	Kronske žage v setu (mm)	Cena z DDV	
D-33641	4-delni set HSS-BiM kronske žage z adapterjem in centrinim svedrom	22, 25, 29, 32		
D-33641-14	4-delni set HSS-BiM kronske žage z adapterjem in centrinim svedrom (14/1)	22, 25, 29, 32		
D-33657	6-delni set HSS-BiM kronske žage z adapterjem in centrinim svedrom	22, 29, 32, 51		
D-33657-10	6-delni set HSS-BiM kronske žage z adapterjem in centrinim svedrom (10/1)	22, 29, 32, 51		
D-47117	6-delni set BiM kronske žage za inštalaterje: 19,22,29,38,44,57 mm	19, 22, 29, 38, 44, 57		
D-47123	6-delni set HSS-BiM kronske žage za električarje	16, 20, 25, 32, 40, 51		

[Nadaljevanje...](#)

- Akumulat orj in polnilnik
- Pribor za akumulat orsko orodje
- Akumulat orske svetilke in pribor
- Pribor za laserske merilnike
- Pribor za rušenje in vrtanje
- Pribor za vrtanje
- Kronske žage**
- Pribor za vijačenje
- Pribor za rezanje in brušenje
- Pribor za poliranje in brušenje
- Pribor za rezkanje in oblanje
- Pribor za multitank cjsko orodje
- Pribor za žaganje
- Pribor za žebjalnike in spenjalnike
- Pribor za fene
- Pribor za sesanje
- Pribor orodja za uporabo na prostem
- Pribor za ročno orodje in zaščitna oprema
- Kovčki in torbe za orodje
- Ročno orodje
- Razno
- Pribor za mešanje

## Kronske žage

	Koda	Naziv	Kronske žage v setu (mm)	Cena z DDV
	D-47139	6-delni set HSS-BiM kronske žage za električarje	20, 25, 32, 40, 51, 65	
	D-63965	9 delni set BIM kronske žage z adapterjem in centrinim svedrom za inštalaterje	19, 22, 29, 38, 44, 57	
	D-63971	14 delni set BIM kronske žage z adapterjem in centrinim svedrom za inštalaterje	19, 22, 25, 29, 35, 38, 44, 51, 57, 68, 75	
	D-63987	12 delni set BIM kronske žage z adapterjem in centrinim svedrom za električarje	19, 22, 29, 35, 38, 51, 54, 57, 68	
	D-63993	16 delni univerzalni set BIM kronske žage z adapterjem in centrinim svedrom	16, 19, 22, 25, 32, 35, 37, 44, 51, 57, 64, 68, 76	

## Kronske žage Bi-metal-Co (8%)



## Kronske žage Bi-Metal-Co (8%)



Koda	Premer (Ø) (mm)	Globina vrtnja (mm)	Število obratov - jeklo (min <sup>-1</sup> )	Število obratov - kovine (min <sup>-1</sup> )	Število obratov - barvne kovine (min <sup>-1</sup> )	Cena z DDV
B-29670	16	20	275	550	825	
B-29686	17	20	250	500	750	
B-29692	19	20	230	460	690	
B-29701	20	20	220	440	675	
B-29717	21	20	210	425	660	
B-29723	22	20	195	390	580	
B-29739	25	20	175	350	252	
B-29745	27	20	160	325	480	
B-29751	29	20	150	300	450	
B-29767	30	20	145	285	425	
B-29773	32	20	140	275	410	
B-29789	33	20	135	260	390	
B-29795	35	20	125	250	375	
B-29804	38	20	115	230	345	
B-29810	40	20	110	220	330	
B-29826	41	20	105	210	315	
B-29832	44	20	95	195	295	

[Nadaljevanje...](#)

# Kronske žage



Koda	Premer (Ø) (mm)	Globina vrtnaja (mm)	Število obratov - jeklo (min <sup>-1</sup> )	Število obratov - kovine (min <sup>-1</sup> )	Število obratov - barvne kovine (min <sup>-1</sup> )	Cena z DDV
B-29848	48	20	90	180	270	
B-29854	51	20	85	170	255	
B-29860	54	20	80	160	240	
B-29876	57	20	75	150	225	
B-29882	60	20	70	140	220	
B-29898	64	20	65	135	205	
B-35994	65	20	65	130	200	
B-36005	67	20	65	130	195	
B-36011	68	20	65	130	190	
B-36027	70	20	60	125	185	
B-36033	73	20	60	120	180	
B-36049	76	20	55	115	170	
B-36055	79	20	55	110	165	
B-36061	83	20	50	105	155	
B-36077	86	20	50	100	150	
B-36083	89	20	45	95	145	
B-36099	102	20	40	85	130	
B-36108	127	20	30	65	90	
B-36114	152	20	25	55	75	

## Pribor za kronske žage Bi-Metal-Co (8%)

Koda	Naziv	Cena z DDV	
B-36120	Adapter, 6-kotno vpetje, 16-35 mm		
B-36136	Adapter, 6-kotno vpetje, 38-152 mm		
B-36142	Centrini sveder, 60 mm		

## Set kronske žage Bi-Metal-Co (8%)



Koda	Naziv	Svedri v setu	Cena z DDV	
B-38663	10-delni set BiM-Co kronske žage za strojne inštalaterje	kronske žage: 19, 22, 29, 38, 44, 57 mm; 10 mm šestorobni adapter s centrirnim svedrom 16-35 mm; 13 mm šestorobni adapter s centrirnim svedrom na zaklep 38-152 mm; centrini sveder, izmetalna vzmet		
B-38679	10-delni set BiM-Co kronske žage za električarje	kronske žage: 20, 25, 32, 38, 51, 64 mm; 10 mm šestorobni adapter s centrirnim svedrom 16-35 mm; 13 mm šestorobni adapter s centrirnim svedrom na zaklep 38-152 mm; centrini sveder, izmetalna vzmet		

Akumulat orj in polnilniki  
 Pribor za akumulat orsko orodje  
 Akumulat orske svetilke in pribor  
 Pribor za lasarske merilnike  
 Pribor za rušenje in vrtnje  
 Pribor za vrtnje  
**Kronske žage**  
 Pribor za vijačenje  
 Pribor za rezanje in brušenje  
 Pribor za poliranje in brušenje  
 Pribor za rezkanje in oblanje  
 Pribor za multitfunkcijsko orodje  
 Pribor za žaganje  
 Pribor za žebjalnike in spenjalnike  
 Pribor za fene  
 Pribor za sesanje  
 Pribor orodja za uporabo na prostem  
 Pribor za ročno orodje in zaščitna oprema  
 Kovčki in torbe za orodje  
 Ročno orodje  
 Razno  
 Pribor za mešanje



## Večnamenske TCT kronske žage

## Večnamenske TCT kronske žage

PRIPOROČILO ZA UPORABO: pri vrtnanju držite naravnost pod kotom 90 stopinj.



Koda	Premer (Ø) (mm)	Globina vrtnanja (mm)	Število obratov - les (min <sup>-1</sup> )	Število obratov - plastika (min <sup>-1</sup> )	Število obratov - ploščice (min <sup>-1</sup> )	Število obratov - opeka (min <sup>-1</sup> )	Cena z DDV
D-42678	19	50	1.000	800	500	800	
D-42684	22	60	1.000	800	500	800	
D-42690	25	60	1.000	800	500	800	
D-42709	29	60	1.000	800	500	800	
D-42715	30	60	1.000	800	500	800	
D-42721	32	60	1.000	800	500	800	
D-42737	35	60	1.000	800	500	800	
D-42743	38	60	800	600	400	700	
D-42759	40	60	800	600	400	700	
D-42765	45	60	800	600	400	700	
D-42771	48	60	800	600	400	700	
D-42787	50	60	800	600	400	700	
D-42793	51	60	800	600	400	700	
D-42802	54	60	600	400	400	600	
D-42818	55	60	600	400	400	600	
D-42824	57	60	600	400	400	600	
D-61488	59	60	600	400	400	600	
D-42830	60	60	600	400	400	600	
D-42846	64	60	600	400	400	600	
D-42852	65	60	600	400	400	600	
D-42868	67	60	600	400	400	600	
D-42874	68	60	600	400	400	600	
D-42880	70	60	600	400	400	600	
D-45026	73	60	600	400	400	600	
D-45032	76	60	400	300	300	300	
D-45048	79	60	400	300	300	300	
D-45331	80	60	400	300	300	300	
D-45347	83	60	400	300	300	300	
D-45353	85	60	400	300	300	300	
D-45369	89	60	400	300	300	300	
D-50304	95	60	400	300	300	300	
D-50310	102	60	400	300	300	300	
D-50326	105	60	400	300	300	300	

Akumulat  
orji in  
povlečkiPribor za  
akumulat  
orsko  
orodjeAkumulat  
orske  
svetilke  
in priborPribor za  
laserske  
merilnikePribor za  
rušenje  
in vrtnanjePribor za  
vrtnanjeKronske  
žagePribor za  
vijačenjePribor za  
rezanje  
in  
brušenjePribor za  
poliranje  
in  
brušenjePribor za  
rezkanje  
in  
oblanjePribor za  
multifunk  
cijsko  
orodjePribor za  
žaganjePribor za  
žebjalnike  
in  
spenjalnikePribor za  
fenePribor za  
sesanjePribor  
orodja za  
uporabo  
na prostemPribor za  
nosenje  
orodja in  
zaščita  
opremaKovčki in  
torbe za  
orodjeRočno  
orodje

Razno

Pribor za  
mešanje

# Kronske žage

## Pribor za TCT večnamenske kronske žage



Koda	Naziv	Cena z DDV
D-50332	Adapter s TCT svedrom za 13mm, 22-105 mm	
D-50348	Adapter s TCT svedrom 8x100mm za SDS-Plus, 22-32 mm	
D-50354	Adapter s TCT svedrom 8x100 mm za 13 mm, 19 mm	
D-50360	Adapter s TCT svedrom 8x100mm za SDS-Plus, 19 mm	
D-50376	Adapter s HSS svedrom 8x100 mm za 13 mm, 22-105 mm	
D-50382	Adapter s HSS svedrom 8x100 mm za SDS-Plus, 22-32 mm	
D-50398	Hex Adapter s HSS svedrom 6,35x90 mm za 11 mm, 19 mm	
D-50407	Adapter s HSS svedrom 6,35x90 mm za SDS-Plus, 19 mm	
D-50413	HSS centrini sveder 8x100 mm za žage 22-105 mm	
D-50429	TCT centrini sveder 8x100mm, za žage 22-105 mm	
D-50435	HSS centrini sveder 6,35x90 mm, 19 mm	
D-50441	TCT centrini sveder 8x90 mm, 19 mm	

## Diamantne kronske žage za mokro vrtnje v trdo keramiko



## Diamantne kronske žage za mokro vrtnje v trdo keramiko

Diamantna prevleka zob.

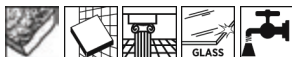

Koda	Premer (Ø) (mm)	Vpetje (mm)	Cena z DDV
D-61210	19	10-13	
D-61226	20	10-13	
D-61232	22	10-13	
D-61248	25	10-13	
D-61254	29	13	
D-61260	32	13	
D-61276	35	13	
D-61282	38	13	
D-61298	41	13	
D-61307	44	13	
D-61313	51	13	
D-61329	54	13	
D-61335	57	13	
D-61341	60	13	
D-61357	64	13	
D-61363	65	13	
D-61379	67	13	
D-61385	68	13	
D-61391	70	13	
D-61400	76	13	
D-61416	79	13	
D-61422	83	13	

Akumulat  
orji in  
poinliniki

Pribor za  
akumulat  
orsko  
orodje

Akumulat  
orske  
svetilke  
in pribor

Pribor za  
laserske  
merilnike

Pribor za  
tršenje  
in vrtnje

Pribor za  
vrtnje

Kronske  
žage

Pribor za  
vijačenje

Pribor za  
rezanje  
in  
brušenje

Pribor za  
poliranje  
in  
brušenje

Pribor za  
režkanje  
in  
oblanje

Pribor za  
multifunk  
cijsko  
orodje

Pribor za  
žaganje

Pribor za  
žebjalnike  
in  
spenjalnike

Pribor za  
fene

Pribor za  
sesanje

Pribor  
orodja za  
uporabo  
na prostem

Pribor za  
ročna  
orodja in  
zaščitna  
oprema

Kovčki in  
torbe za  
orodje



Ročno  
orodje

Razno  
orodje

Pribor za  
mešanje

# Kronske žage

## Pribor za diamantne kronske žage za vrtanje trde keramike

	Koda	Naziv	Cena z DDV
	D-61438	Adapter za krono za keramiko (19-29mm), 9.5mm hex	
	D-61444	Adapter za krono za keramiko (32-83mm), 11mm hex	
	D-61450	Centrirni pripomoček za žage za keramiko: 6mmX74mm	

## Kronske žage z robom iz volframovega karbida

### Kronske žage z robom iz volframovega karbida

PRIPOROČILO ZA UPORABO: pri vrtanju držite naravnost pod kotom 90 stopinj. Uporaba skupaj s centrirnim svedrom. Kronska žaga s konico iz volfram karbida je idealna za vodoinštalacijska in druga notranja zaključna dela, saj je namenjena izključno vrtanju v mehke ploščice in mehke zidake.







Koda	Premer (Ø) (mm)	Celotna dolžina (mm)	Največje število obratov (min <sup>-1</sup> )	Cena z DDV
D-51188	33	54	350	
D-51194	43	57	350	
D-51203	53	57	300	
D-51219	63	57	300	
D-51225	67	57	300	
D-51231	73	57	250	
D-51247	83	57	250	





### Pribor za kronske žage z robom iz volframovega karbida

	Koda	Naziv	Celotna dolžina (mm)	Cena z DDV
	D-51253	Držalo s centrirnim svedrom, 11mm, 90mm, 7/16	90	
	D-51269	Centrirni sveder 90mm, 9/16"	90	

# SETI ZA VIJAČENJE



Artikel	Št. kosov pribora v setu	Tipi vijakov					Adapterji	Natični ključji	Ročno orodje
		PH 	PZ 	TORX 	HEX 	RAVNI 			
D-73265	7	✓					✓		
XX7948-901	12	✓	✓						
P-90071	13		✓	✓	✓	✓	✓		✓
D-73271	7	✓	✓				✓		
P-53746	11	✓	✓				✓		
D-65028	10	✓	✓	✓			✓		
D-64995	11	✓	✓	✓			✓		
P-74740	13	✓	✓	✓			✓		
P-73374	31	✓	✓	✓			✓		
E-10942	8	✓	✓	✓		✓	✓		✓
P-16782	10	✓	✓	✓			✓		
P-38750	11	✓	✓	✓			✓		
P-70144	61	✓	✓	✓			✓		
E-10899	76	✓	✓	✓			✓	✓	✓
B-68323	21	✓	✓	✓	✓		✓		
E-07048	28	✓	✓	✓	✓		✓	✓	
E-07060	30	✓	✓	✓	✓		✓	✓	
B-68317	31	✓	✓	✓	✓		✓		
D-65084	32	✓	✓	✓	✓		✓		
E-07076	32	✓	✓	✓	✓		✓		
B-55697	43	✓	✓	✓	✓		✓		
D-73461	47	✓	✓	✓	✓		✓		
B-54081	21	✓	✓	✓	✓		✓	✓	✓
E-08458	87	✓	✓	✓	✓		✓	✓	✓
E-11542	87	✓	✓	✓	✓		✓	✓	✓
E-06616	120	✓	✓	✓	✓		✓	✓	✓
E-08713	120	✓	✓	✓	✓		✓	✓	✓
E-10883	221	✓	✓	✓	✓		✓	✓	✓

Artikel	Št. kosov pribora v setu	Tipi vijakov					Adapterji	Natični ključji	Ročno orodje	Št. setov v paketu
		PH 	PZ 	TORX 	HEX 	RAVNI 				
D-30651									1	
D-30651-12	11	✓	✓	✓			✓		12/1	
D-31083									1	
D-31083-12	12	✓	✓	✓			✓		12/1	
B-28896									1	
B-28896-6	18	✓	✓			✓	✓		6/1	
B-28911									1	
B-28911-6	28	✓	✓	✓	✓	✓	✓		6/1	
D-30667									1	
D-30667-12	31	✓	✓	✓			✓		12/1	
E-00016									1	
E-00022	31	✓	✓	✓	✓	✓	✓		12/1	
D-74762									1	
D-74762-12	32	✓	✓	✓			✓		12/1	
B-36170									1	
B-36170-10	47	✓	✓	✓			✓	✓	10/1	



D-73265



XX7948-901



P-90071



D-73271



P-53746



D-65028

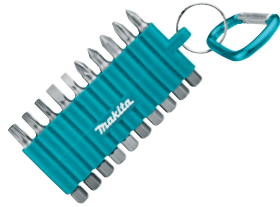

D-64995



P-74740



P-73374



E-10942



P-16782



P-38750



P-70144



E-10899



B-68323



E-07048



E-07060



B-68317



D-65084



E-07076



B-55697



D-73461



B-54081



E-08458



E-11542



E-06616



E-08713



E-10883



D-30651



D-30651-12



D-31083



D-31083-12



B-28896



B-28896-6



B-28911



B-28911-6



D-30667



D-30667-12



E-00016



E-00022



D-74762



D-74762-12



B-36170









B-36170-10



# SETI ZA VRTANJE



Artikel	Št. kosov pribora v setu	Dimenzije		
		Kamen 	Kovina 	Les 
D-05175	5	4, 5, 6, 8, 10 mm		
E-11536	5	4, 5, 6, 8, 10 mm		
D-72877	5	4, 5, 6, 8, 10 mm		
D-73483	12	4, 5, 2x5.5, 2x6, 2x6.5, 2x7, 2x8 mm		
D-30508	5		4, 5, 6, 8, 10 mm	
D-72833	6		2, 3, 4, 5, 6, 8 mm	
D-72849	10		1, 2, 3, 4, 5, 6, 7, 8, 9, 10 mm	
D-72855	13		1.5, 2, 2.5, 3, 3.2, 3.5, 4, 4.5, 4.8, 5, 5.5, 6, 6.5 mm	
P-51873	16		1.5 - 2 kosa 2, 2.5, 3, 3.2, 3.5, 4, 4.5, 5, 5.5, 6, 6.5, 7, 8, 10 mm - 1 kos	
D-67527	19		1.5, 2, 2.5, 3, 3.2, 3.5, 4, 4.5, 5, 5.5, 6, 6.5, 7, 8, 10 mm	
D-67549	19		1, 1.5, 2, 2.5, 3, 3.5, 4, 4.5, 5, 5.5, 6, 6.5, 7, 7.5, 8, 8.5, 9, 9.5, 10 mm	
D-67561	19		1, 1.5, 2, 2.5, 3, 3.5, 4, 4.5, 5, 5.5, 6, 6.5, 7, 7.5, 8, 8.5, 9, 9.5, 10 mm	
D-67583	19		1, 1.5, 2, 2.5, 3, 3.5, 4, 4.5, 5, 5.5, 6, 6.5, 7, 7.5, 8, 8.5, 9, 9.5, 10 mm	
P-73673	19		1, 1.5, 2, 2.5, 3, 3.5, 4, 4.5, 5, 5.5, 6, 6.5, 7, 7.5, 8, 8.5, 9, 9.5, 10 mm	
P-60969-25	25		1 - 13 mm (narašča za 0.5 mm)	
P-61824-25	25		1 - 13 mm (narašča za 0.5 mm)	
D-30564	170		1 - 8 mm (narašča za 0.5 mm), 8 - 10 mm (narašča po 0.5 mm)	
D-20769	5		5, 6, 8 mm	5, 6 mm
D-72861	5			4, 5, 6, 8, 10 mm
E-08698	8			12, 14, 16, 18, 20, 22, 25, 32 mm
D-23759	5	6 mm	5, 6 mm	5, 6 mm
D-71962	9	5, 6, 8 mm	5, 6, 8 mm	5, 6, 8 mm
D-46202	18	3, 4, 5, 6, 8, 10 mm	3, 4, 5, 6, 8, 10 mm	3, 4, 5, 6, 8, 10 mm
B-44884	21	2x3, 2x4, 5, 6, 8 mm	2x3, 2x4, 5, 6, 8 mm	2x3, 2x4, 5, 6, 8 mm

Artikel	Št. kosov pribora v setu							
E-14255	5							

4x75 mm, 5x85 mm, 6x100 mm, 8x120 mm, 10x150 mm



D-05175



E-11536



D-72877



D-73483



D-30508



D-72833



D-72849



D-72855



P-51873

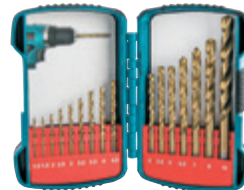

D-67527



D-67549



D-67561



D-67583



P-73673



P-60969-25



P-61824-25



D-30564



D-20769



D-72861



E-08698



D-23759



D-71962



D-46202



B-44884









E-14255



# SETI ZA VIJAČENJE IN VRTANJE



Artikel	Št. kosov pribora v setu	Svedri			Kronske žage	Vijačni nastavki	Natični ključi	Ročno orodje
		Kamen 	Kovina 	Les 				
E-07026	18	✓	✓			✓	✓	
B-54106	38		✓			✓	✓	
D-58877	42		✓			✓	✓	
D-74887	17	✓	✓	✓		✓		
E-07032	27	✓	✓	✓		✓		
E-07054	29	✓	✓	✓		✓		
D-36980	34	✓	✓	✓		✓	✓	
B-68498	34	✓	✓	✓		✓	✓	
E-11829	60	✓	✓	✓		✓		
B-69478	65	✓	✓	✓		✓	✓	✓
196635-4	70	✓	✓	✓		✓	✓	
D-33691	71	✓	✓	✓		✓	✓	✓
E-10730	102	✓	✓	✓	✓	✓		✓
D-31778	104	✓	✓	✓		✓	✓	✓
D-37194	200	✓	✓	✓	✓	✓	✓	✓
E-06270	212	✓	✓	✓	✓	✓	✓	✓
E-11689	256	✓	✓	✓	✓	✓	✓	✓

Artikel	Št. kosov pribora v setu	Svedri			Kronske žage	Vijačni nastavki	Natični ključi	Ročno orodje	Št. setov v paketu
		Kamen 	Kovina 	Les 					
D-47204	30	✓	✓	✓		✓		1	
D-47204-10								10/1	
D-47145	71	✓	✓	✓		✓		1	
D-47145-6							✓	6/1	
D-47248	100	✓	✓	✓		✓		1	
D-47248-5							✓	5/1	
D-47260	201	✓	✓	✓		✓		1	
D-47260-2					✓	✓	✓	✓	2/1



E-07026

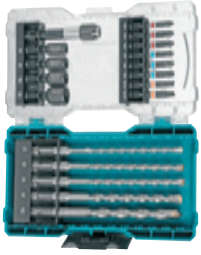

B-54106

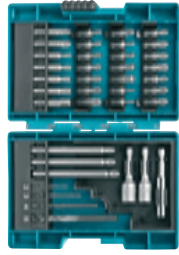

D-58877



D-74887



E-07032



E-07054



D-36980



B-68498



E-11829



B-69478



196635-4



D-33691



E-10730



D-31778



D-37194



E-06270



E-11689



D-47204

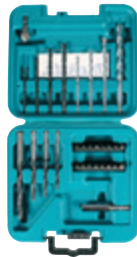

D-47204-10



D-47145



D-47145-6



D-47248



D-47248-5



D-47260



D-47260-2



# PRIBOR ZA VIJAČENJE

SL vijačni nastavek



PH vijačni nastavek



PZ vijačni nastavek



Torx vijačni nastavek



Štiriobni vijačni nastavek



Šestkotni vijačni nastavek



Za kvadratno vpetje 3/8"



Za kvadratno vpetje 3/4"



Za kvadratno vpetje 1/2"



Za kvadratno vpetje 1"



1/4" šestrobno vpetje



Z magnetom



Izdelano iz krom-molibdena





**Impact**

# PREMIER

**DVO-TORZIJSKI**  
ZA VISOKO VZDRŽLJIVOST

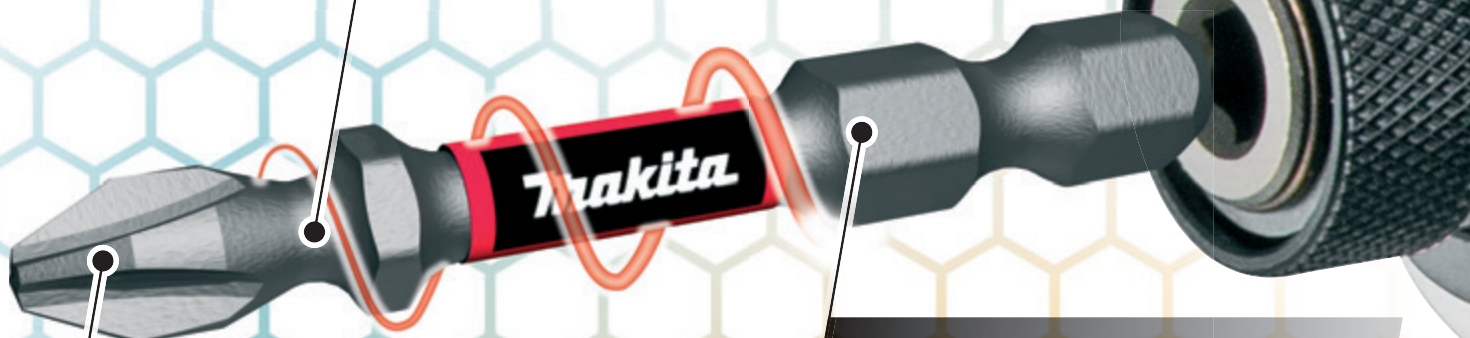

**JEKLENA ZLITINA**  
USTVARJENA ZA VISOKE NAVORE

**ZELO NATANČNO**  
PRILEGANJE GLAVI VIJAKA

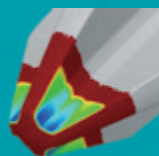
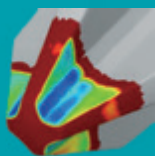

grafični prikaz prileganja



PREMIER

STANDARD

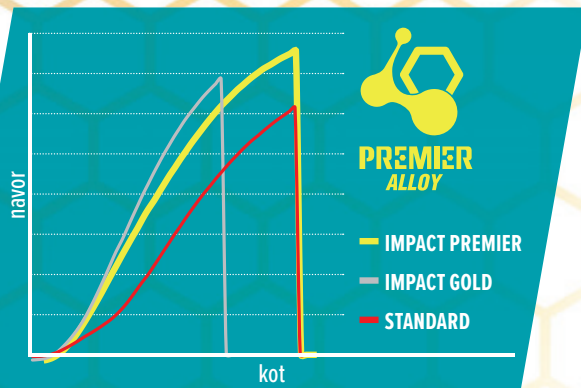

## NOVA SERIJA

VIJAČNIH NASTAVKOV | DRŽAL | ADAPTERJEV

## Impact Premier vijačni nastavki in adapterji



## Impact Premier vijačni nastavki 25mm

Natančno izdelana konica se odlično prilega v glave vijakov. Izjemno vzdržljivi torzijski nastavki. Barvne oznake za boljšo prepoznavnost.

Impact  
**PREMIER**

Koda	Celotna dolžina (mm)	Tip vijaka	Tip	Vpetje	Enota (kos/set)	Cena z DDV
E-03121	25	PH1	torzijski	1/4"	2/1	
E-03143	25	PH2	"Super slim" torzijski	1/4"	2/1	
E-03246	25	PH2	torzijski	1/4"	15/1	
E-03137	25	PH2	torzijski	1/4"	2/1	
E-03159	25	PH3	torzijski	1/4"	2/1	
E-03165	25	PZ1	torzijski	1/4"	2/1	
E-03252	25	PZ2	torzijski	1/4"	15/1	
E-03171	25	PZ2	torzijski	1/4"	2/1	
E-03187	25	PZ3	torzijski	1/4"	2/1	
E-03193	25	T10	torzijski	1/4"	2/1	
E-03202	25	T15	torzijski	1/4"	2/1	
E-03218	25	T20	torzijski	1/4"	2/1	
E-03224	25	T25	torzijski	1/4"	2/1	
E-03230	25	T30	torzijski	1/4"	2/1	



## Impact Premier vijačni nastavki 50mm



Impact  
**PREMIER**

Koda	Celotna dolžina (mm)	Tip vijaka	Tip	Vpetje	Enota (kos/set)	Cena z DDV
E-03268	50	PH1	dvojni torzijski magnetni	1/4"	2/1	
E-03377	50	PH2	dvojni torzijski magnetni	1/4"	10/1	
E-03274	50	PH2	dvojni torzijski magnetni	1/4"	2/1	
E-03280	50	PH3	dvojni torzijski magnetni	1/4"	2/1	
E-03296	50	PZ1	dvojni torzijski magnetni	1/4"	2/1	
E-03383	50	PZ2	dvojni torzijski magnetni	1/4"	10/1	
E-03305	50	PZ2	dvojni torzijski magnetni	1/4"	2/1	
E-03311	50	PZ3	dvojni torzijski magnetni	1/4"	2/1	
E-03327	50	T10	dvojni torzijski magnetni	1/4"	2/1	
E-03333	50	T15	dvojni torzijski magnetni	1/4"	2/1	
E-03349	50	T20	dvojni torzijski magnetni	1/4"	2/1	
E-03355	50	T25	dvojni torzijski magnetni	1/4"	2/1	
E-03361	50	T30	dvojni torzijski magnetni	1/4"	2/1	

Nadaljevanje...



# Pribor za vijačenje

111

Koda	Celotna dolžina (mm)	Tip vijaka	Tip	Vpetje	Enota (kos/set)	Cena z DDV
E-12027	50	T40	dvojni torzijski magnetni	1/4"	2/1	

## Impact Premier dvostranski vijačni nastavki



Impact  
**PREMIER**



Koda	Celotna dolžina (mm)	Tip vijaka	Tip	Vpetje	Enota (kos/set)	Cena z DDV
E-06286	65	PH2-PH2	dvojni torzijski magnetni	1/4"	2/1	
E-06292	65	PZ2-PZ2	dvojni torzijski magnetni	1/4"	2/1	



## Impact Premier natični ključ



Impact  
**PREMIER**

Koda	Naziv	Celotna dolžina (mm)	Dimenzija ključa	Tip	Vpetje	Cena z DDV	
E-03458	Natični ključ torsion Impact Premier H6 x 65mm	65	6 mm	magnetni	1/4"		
E-03464	Natični ključ torsion Impact Premier H8 x 65mm	65	8 mm	magnetni	1/4"		
E-03470	Natični ključ torsion Impact Premier H10 x 65mm	65	10 mm	magnetni	1/4"		
E-03486	Natični ključ torsion Impact Premier H13 x 65mm	65	13 mm	magnetni	1/4"		
E-03492	Natični ključ nagibni Impact Premier H13 x 80mm	80	13 mm	magnetni	1/4"		
E-03501	Natični ključ nagibni Impact Premier H15 x 80mm	80	15 mm	magnetni	1/4"		
E-03517	Natični ključ nagibni Impact Premier H17 x 80mm	80	17 mm	magnetni	1/4"		
E-03523	Natični ključ nagibni Impact Premier H19 x 80mm	80	19 mm	magnetni	1/4"		
E-03539	Natični ključ nagibni Impact Premier H21 x 80mm	80	21 mm	magnetni	1/4"		

Akumulat  
orj in  
poinliniki

Pribor za  
akumulat  
orsko  
orodje

Akumulat  
orske  
svetilke  
in pribor

Pribor za  
lasarske  
merilnike

Pribor za  
rušenje  
in vrtanje

Pribor za  
vrtanje

Kronske  
žage

Pribor za  
vijačenje

Pribor za  
rezanje  
in  
brušenje

Pribor za  
poliranje  
in  
brušenje

Pribor za  
rezkanje  
in  
oblanje

Pribor za  
multitank  
ciljsko  
orodje

Pribor za  
žaganje

Pribor za  
žebjalnike  
in  
spenjalnike

Pribor za  
fene

Pribor za  
sesanje

Pribor  
orodja za  
uporabo  
na prostem

Pribor za  
ploščne  
orodja in  
zaščitna  
oprema

Kovčki in  
torbe za  
orodje

Ročno  
orodje

Razno

Pribor za  
mešanje



## Impact Premier adapterji, držala

**Impact**  
**PREMIER**

	Koda	Naziv	Celotna dolžina (mm)	Dimenzija ključa (mm)	Tip	Vpetje	Cena z DDV
	E-03442	Magnetno držalo Impact Premier za vijačne nastavke	/	/	magnetni	/	
	E-03420	Adap. Impact Premier za natične ključe 50mm SQ3/8	50	SQ 3/8"	navaden	1/4"	
	E-03436	Adap. Impact Premier za natične ključe 50mm SQ1/2	50	SQ 1/2"	navaden	1/4"	
	E-03399	Torsion adapter Impact Premier za nastavke 68mm	68	/	magnetni	1/4"	
	E-03414	Ultramag Impact Premier držalo za nastavke in vij.	79	/	magnetni	1/4"	
	E-03408	Torsion adapter Impact Premier za nastavke 150mm	150	/	magnetni	1/4"	



## Impact Premier seti

**Impact**  
**PREMIER**

	Koda	Naziv	Vijačni nastavki	Cena z DDV
	E-03567	11-delni set Impact Premier nastavkov in adapt.	25 mm: PH1, PH2, PH3, PZ1, PZ2, PZ3, T15, T20, T25, T30; držalo nastavkov 50 mm	
	E-03573	11-delni set Impact Premier z mag. nast. za vijake	25 mm: PH2, PZ1, 2xPZ2, PZ3, T20, T25, T30, SL4, SL6; držalo nastavkov 50 mm	

# IMPACT BLACK

NOVA SERIJA VIJAČNIH NASTAVKOV | DRŽAL | ADAPTERJEV

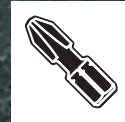

Vzdržljivo  
jeklo za dolgo  
življenjsko  
dobo



Toplotno  
obdelano  
za večjo  
vzdržljivost



Natančna  
konica  
preprečuje  
izpad vijaka

## VIJAČNI NASTAVKI

### Torsion vijačni nastavki

25 mm nastavki brez magnet.



Ph Pz T



### Magnetno držalo nastavkov

60 mm



### Torsion magnetni vijačni nastavki

50 mm nastavki z magnetom.



Ph Pz T



### Hitrovpenjalno držalo nastavkov

60 mm



### Natični magnetni ključi

50 mm | 6,8, 10, 13 mm



### Držalo nastavkov z vodilom

80 mm



### Adapterja za nasadne ključe

50 mm 3/8" | 50 mm 1/2"



## SETI

IMPACT  
BLACK



## Impact Black adapterji, držala in natični ključi

## Torzijski vijačni nastavki

Široka izbira 25/50 mm torzijskih vijačnih nastavkov, ki so za zaradi posebnega postopka kaljenja za 20 odstotkov bolj trajnejši od klasičnih vijačnih nastavkov.



**IMPACT BLACK**  
Impact driver's accessory series

Koda	Celotna dolžina (mm)	Tip vijaka	Tip	Enota (kos/set)	Cena z DDV
B-63600	25	PH1	torzijski	2/1	
B-63719	50	PH1	torzijski magnetni	2/1	
E-12407	50	PH2	torzijski	10/1	
B-63616	25	PH2	torzijski	2/1	
B-63725	50	PH2	torzijski magnetni	2/1	
E-12360	25	PH2	torzijski	25/1	
B-63622	25	PH3	torzijski	2/1	
B-63731	50	PH3	torzijski magnetni	2/1	
B-63638	25	PZ1	torzijski	2/1	
B-63747	50	PZ1	torzijski magnetni	2/1	
E-12413	50	PZ2	torzijski	10/1	
B-63644	25	PZ2	torzijski	2/1	
B-63753	50	PZ2	torzijski magnetni	2/1	
E-12376	25	PZ2	torzijski	25/1	
B-63650	25	PZ3	torzijski	2/1	
B-63769	50	PZ3	torzijski magnetni	2/1	
B-63666	25	T15	torzijski	2/1	
B-63775	50	T15	torzijski magnetni	2/1	
E-12429	50	T20	torzijski	10/1	
B-63672	25	T20	torzijski	2/1	
B-63781	50	T20	torzijski magnetni	2/1	
E-12382	25	T20	torzijski	25/1	
E-12435	50	T25	torzijski	10/1	
B-63688	25	T25	torzijski	2/1	
B-63797	50	T25	torzijski magnetni	2/1	
E-12398	25	T25	torzijski	25/1	
E-12675	50	T30	torzijski	10/1	
B-63694	25	T30	torzijski	2/1	
B-63806	50	T30	torzijski magnetni	2/1	
E-12653	25	T30	torzijski	25/1	
E-12681	50	T40	torzijski	10/1	
B-63703	25	T40	torzijski	2/1	
B-63812	50	T40	torzijski magnetni	2/1	
E-12669	25	T40	torzijski	25/1	

Akumulat  
ori in  
povleki

Pribor za  
akumulat  
orsko  
orodje

Akumulat  
orske  
svetilke  
in pribor

Pribor za  
laserske  
merilnike

Pribor za  
rušenje  
in vrtanje

Pribor za  
vrtanje

Kronske  
žage

Pribor za  
vijačenje

Pribor za  
rezanje  
in  
brušenje

Pribor za  
poliranje  
in  
brušenje

Pribor za  
rezkanje  
in  
oblanje

Pribor za  
multifunk  
cijsko  
orodje

Pribor za  
žaganje

Pribor za  
žebjalnike  
in  
spenjalnike

Pribor za  
fene

Pribor za  
sesanje

Pribor  
orodja za  
uporabo  
na prostem

Pribor za  
nosenje  
orodja in  
zaščitna  
oprema

Kovčki in  
torbe za  
orodje

Ročno  
orodje

Razno

Pribor za  
mešanje



## Impact Black držala



**IMPACT BLACK**  
Impact driver's accessory series

Koda	Naziv	Celotna dolžina (mm)	Vpetje	Cena z DDV	
B-66793	Impact BLACK magnetno držalo nastavkov	60	1/4"		
B-66802	Impact BLACK hitrovpenjalno držalo nastavkov	60	1/4"		
B-66818	Impact BLACK držalo nastavkov z vodilom	80	1/4"		
B-66868	Impact Black adapter za nasadne ključce 3/8"	50	1/4"		
B-66874	Impact BLACK adapter za nasadne ključce 1/2"	50	1/4"		

## Impact Black natični magnetni ključji



**IMPACT BLACK**  
Impact driver's accessory series









Koda	Naziv	Celotna dolžina (mm)	Dimenzija ključca	Vpetje	Tip vijaka	Tip	Cena z DDV	
B-66824	Impact BLACK natični magnetni ključ	50	6 mm	1/4"	M3,5	magnetni		
B-66830	Impact BLACK natični magnetni ključ	50	8 mm	1/4"	M5	magnetni		
B-66846	Impact BLACK natični magnetni ključ	50	10 mm	1/4"	M6	magnetni		
B-66852	Impact BLACK natični magnetni ključ	50	13 mm	1/4"	M8	magnetni		

- Akumulat orji in polnilniki
- Pribor za akumulat orsko orodje
- Akumulat orske svetilke in pribor
- Pribor za laserske merilnike
- Pribor za rušenje in vrtanje
- Pribor za vrtanje
- Kronске žage
- Pribor za vijačenje
- Pribor za rezanje in brušenje
- Pribor za poliranje in brušenje
- Pribor za rezkanje in oblanje
- Pribor za multitank ciljsko orodje
- Pribor za zaganje
- Pribor za žebjalnike in spenjalnike
- Pribor za fene
- Pribor za sesanje
- Pribor orodja za uporabo na prostem
- Pribor za čiščenje orodja in zaščitna oprema
- Kovčki in torbe za orodje
- Ročno orodje
- Razno
- Pribor za mešanje



**IMPACT BLACK**  
Impact driver's accessory series

## Seti

	Koda	Naziv	Vijačni nastavki	Enota (kos/set)	Cena z DDV
	B-66880	35 delni set vijačnih nastavkov	25mm vijačni nastavki: PH1-PH3, PZ1-PZ3, T15-T30 / 50mm vijačni nastavki: PH1-PH3, PZ1-PZ3, T15-T30, SL 0.8x5.5 / Natični magnetni ključi 6-13mm / Magnetno držalo nastavkov	1	
	B-66896	33 delni set vijačnih nastavkov	25mm vijačni nastavki: PH1-PH3, PZ1-PZ3, T15-T30 / 50mm vijačni nastavki: PH2, PZ2, T15-T30 / 1/4" HSS twist drill 2,5-5mm/ Nat. mag.ključ 6-10mm / Mag. držalo nastavkov /Držalo vij. nastavkov	1	
	E-03084	31 delni set IMPACT BLACK nastavkov	25mm: 2xPH1, 5xPH2, 2xPH3, 2xPZ1, 5xPZ2, 2xPZ3, 3xT15, 3xT20, 3xT25, 3xT30, 60 mm magnetno držalo	1	
	E-03109	90 delni set IMPACT BLACK nastavkov	25mm: 5xPH1, 10xPH2, 5xPH3, 5xPZ1, 10xPZ2, 5xPZ3, 6xT15, 6xT20, 6xT25, 6xT30; 50mm: PH1, 4xPH2, 2xPH3, PZ1, 4xPZ2, 2xPZ3, 2xT15, 2xT20, 2xT25, 2xT30, SL0.8x5.5, 60mm magnetno držalo, 50mm natični magnetni ključ: 6, 8mm	1	
	E-11994	8 delni set IMPACT BLACK nastavkov	25mm: PH1, 2xPH2, PH3, PZ1, PZ2, PZ3, 60mm magnetno držalo nastavkov	1	
	E-12011	10 delni set IMPACT BLACK nastavkov	50 mm: PH1, PH2, PH3, PZ1, PZ2, PZ3, T15, T20, T25, T30	1	
	E-12441	33-delni set za vijačenje IMPACT BLACK	PH1, 2xPH2, PH3, PZ1, 2xPZ2, PZ3, T10, T15, 2xT20, T25, T27, T30, T40, T10H, T15H, T20H, T25H, T27H, T30H, T40H, SL0.5x3, SL0.8x4, SL0.8x5, SL1.2x6.5, HEX3, HEX4, HEX5, HEX6, Hitrovpensalno držalo vijačnih nastavkov 60 mm (MZ), Adapter 1/4"	1	
	E-12441-10	33-delni set za vijačenje IMPACT BLACK (pk/10kos)	PH1, 2xPH2, PH3, PZ1, 2xPZ2, PZ3, T10, T15, 2xT20, T25, T27, T30, T40, T10H, T15H, T20H, T25H, T27H, T30H, T40H, SL0.5x3, SL0.8x4, SL0.8x5, SL1.2x6.5, HEX3, HEX4, HEX5, HEX6, Hitrovpensalno držalo vijačnih nastavkov 60 mm (MZ), Adapter 1/4"	10/1	

## Vijačni nastavki

### Phillips (PH) vijačni nastavki

DIN3126



Koda	Celotna dolžina (mm)	Tip vijaka	Tip	Vpetje	Enota (kos/set)	Cena z DDV
P-06030	25	PH1	torzijski	1/4"	10/1	
P-06052	25	PH2	torzijski	1/4"	10/1	
P-06074	25	PH3	torzijski	1/4"	10/1	
P-06046	50	PH1	torzijski	1/4"	10/1	
P-06068	50	PH2	torzijski	1/4"	10/1	
P-06080	50	PH3	torzijski	1/4"	10/1	
B-57788	90	PH2	navaden	1/4"	1/1	
B-57847	150	PH2	navaden	1/4"	1/1	
B-57853	150	PH3	navaden	1/4"	1/1	

### Pozidrive (PZ) vijačni nastavki

DIN3126



Koda	Celotna dolžina (mm)	Tip vijaka	Tip	Vpetje	Enota (kos/set)	Cena z DDV
P-06096	25	PZ1	torzijski	1/4"	10/1	
P-06111	25	PZ2	torzijski	1/4"	10/1	
P-06133	25	PZ3	torzijski	1/4"	10/1	
P-06105	50	PZ1	torzijski	1/4"	10/1	
P-06127	50	PZ2	torzijski	1/4"	10/1	
P-06149	50	PZ3	torzijski	1/4"	10/1	
B-59885	90	PZ2	navaden	1/4"	1/1	
B-59950	150	PZ2	navaden	1/4"	1/1	
B-59966	150	PZ3	navaden	1/4"	1/1	

### Torx (T) vijačni nastavki

DIN3126



Koda	Celotna dolžina (mm)	Tip vijaka	Tip	Vpetje	Enota (kos/set)	Cena z DDV
P-06339	25	T15	navaden	1/4"	10/1	
P-06345	25	T20	navaden	1/4"	10/1	
P-06351	25	T25	navaden	1/4"	10/1	
P-06367	25	T27	navaden	1/4"	10/1	
P-06373	25	T30	navaden	1/4"	10/1	
P-06389	25	T40	navaden	1/4"	10/1	

[Nadaljevanje...](#)

Akumulatorji in polnilniki

Pribor za akumulatsko orodje

Akumulatorske svetilke in pribor

Pribor za lasarske merilnike

Pribor za rušenje in vrtanje

Pribor za vrtanje

Kronske žage

Pribor za vijačenje

Pribor za rezanje in brušenje

Pribor za poliranje in brušenje

Pribor za rezkanje in oblanje

Pribor za multitank orodje

Pribor za žaganje

Pribor za žebjalnike in spenjalnike

Pribor za fene

Pribor za sesanje

Pribor orodja za uporabo na prostem

Pribor za čiščenje orodja in zaščitna oprema

Kovčki in torbe za orodje

Ročno orodje

Razno

Pribor za mešanje

# Pribor za vijačenje

Koda	Celotna dolžina (mm)	Tip vijaka	Tip	Vpetje	Enota (kos/set)	Cena z DDV
P-72590	50	T10	navaden	1/4"	3/1	
P-72609	50	T15	navaden	1/4"	3/1	
P-72615	50	T20	navaden	1/4"	3/1	
P-72643	50	T30	navaden	1/4"	3/1	
P-72659	50	T40	navaden	1/4"	3/1	
B-59900	90	T15	navaden	1/4"	1/1	
B-59916	90	T20	navaden	1/4"	1/1	
B-59922	90	T25	navaden	1/4"	1/1	
B-59938	90	T30	navaden	1/4"	1/1	
B-59972	150	T15	navaden	1/4"	1/1	
B-59988	150	T20	navaden	1/4"	1/1	
B-59994	150	T25	navaden	1/4"	1/1	
B-60006	150	T30	navaden	1/4"	1/1	

## Štirirobni (SQ) vijačni nastavki



Koda	Celotna dolžina (mm)	Tip vijaka	Vpetje	Tip	Cena z DDV
B-57825	90	SQ3	1/4"	magnetni	
B-57869	150	SQ1	1/4"	magnetni	
B-57875	150	SQ2	1/4"	magnetni	
B-57881	150	SQ3	1/4"	magnetni	

## Dvostranski vijačni nastavki (PH, PZ)

Udarni vijačniki proizvedejo visok moment, ki uniči običajne vijačne nastavke. Makita dvojni vijačni nastavek presega vsa pričakovanja in zdrži do 10-krat dlje od običajnih vijačnih nastavkov.

















Koda	Celotna dolžina (mm)	Tip vijaka	Tip	Vpetje	Enota (kos/set)	Cena z DDV
B-20703	65	PH2	torzijski	1/4"	3/1	
B-20719	65	PZ2	torzijski	1/4"	3/1	
B-20725	65	PZ3	torzijski	1/4"	3/1	
B-21870	65	PH3	torzijski	1/4"	3/1	
B-12326	85	PH2	torzijski	1/4"	3/1	
B-12790	85	PZ2	torzijski	1/4"	3/1	
B-16259	85	PZ2	torzijski	1/4"	18/1	
B-20731	85	PZ3	torzijski	1/4"	3/1	
B-21886	85	PH3	torzijski	1/4"	3/1	



## Adapterji, držala in BITRO vijačni nastavki za svedre

### Adapterji, držala in BITRO vijačni nastavki za svedre

Koda	Naziv	Celotna dolžina (mm)	Vpetje	Cena z DDV	
B-54411	Držalo - obesek vijačnih nastavkov	/	1/4"		
D-61690	Suhomontažni vijačni nastavek PH2 z omejitnikom globine	30	1/4"		
D-74740	Držalo za SQ 1/4" natične ključe	50	1/4"		
784811-8	Držalo vijačnih nastavkov s trajnim magnetom	60	1/4"		
B-52445	Držalo vijačnih nastavkov s trajnim magnetom	60	1/4"		
B-52467	Hitrovpensalno držalo vijačnih nastavkov	60	1/4"		
P-05979	Držalo vijačnih nastavkov s trajnim magnetom	60	1/4"		
P-54075	Hitrovpensalno držalo vijačnih nastavkov	60	1/4"		
P-05985	Držalo vijačnih nastavkov s trajnim magnetom	75	1/4"		
B-52934	Držalo vijačnih nastavkov 120 mm - prozoren	120	1/4"		
B-57750	Magnetno držalo za nastavke, dolg z obročem	150	1/4"		
B-57738	Adapter za SQ 3/8 natične ključe	152	1/4"		
B-57744	Adapter za SQ 1/2 natične ključe	152	1/4"		
B-29072	Gibljivo držalo vijačnih nastavkov	200	1/4"		
B-29094	Gibljivo držalo vijačnih nastavkov	300	1/4"		
B-57766	Magnetno držalo za nastavke, dolg z obročem	300	1/4"		

Akumulatorji in polnilniki

Pribor za akumulatorsko orodje

Akumulatorske svetilke in pribor

Pribor za laserske merilnike

Pribor za rušenje in vrtanje

Pribor za vrtanje

Kronske žage

Pribor za vijačenje

Pribor za rezanje in brušenje

Pribor za poliranje in brušenje

Pribor za rezkanje in oblanje

Pribor za multitank orodje

Pribor za vrtanje

Pribor za žebjalnike in spenjalnike

Pribor za fene

Pribor za sesanje

Pribor orodja za uporabo na prostem

Pribor za varnostno opremo

Kovčki in torbe za orodje

Ročno orodje

Razno

Pribor za mešanje

## Natični ključ

## Natični ključ



Koda	Celotna dolžina (mm)	Dimenzija ključa	Tip	Vpetje	Cena z DDV
P-06270	55	5,5	navaden	1/4"	
P-06286	55	7	navaden	1/4"	
P-06292	55	8	navaden	1/4"	
P-06301	55	10	navaden	1/4"	
P-06317	55	13	navaden	1/4"	
P-38548	55	17	navaden	1/4"	

## Natični magnetni ključ

Odličen pripomoček za različne vrste dela. Natični magnetni ključ se običajno uporablja za pritrdjevanje šestkotnih vijakov. Magnet trdno drži glavo vijaka in preprečuje zdrs, kar je pomembno pri višinskih delih in pri enoročnem delu. Ciljna skupina uporabnikov so kleparji, krovci, izvajalci zaključnih del, izvajalci del na zunanjih površinah stavb.

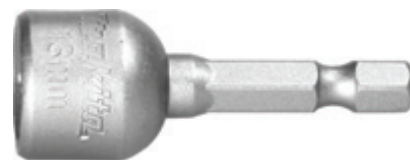

Koda	Celotna dolžina (mm)	Dimenzija ključa	Vpetje	Enota (kos/set)	Cena z DDV
B-38685	50	5,5 mm	1/4"	1	
B-38691	50	6 mm	1/4"	1	
B-38700	50	7 mm	1/4"	1	
B-38716	50	8 mm	1/4"	1	
B-38722	50	10 mm	1/4"	1	
B-38738	50	12 mm	1/4"	1	
B-38744	50	13 mm	1/4"	1	
B-38750	50	17 mm	1/4"	1	
B-38766	50	6,35 mm (1/4")	1/4"	1	
B-38772	50	7,9 mm (5/16")	1/4"	1	
B-38788	50	9,6 mm (3/8")	1/4"	1	
B-38906	50	5,5 mm	1/4"	1	
B-38912	50	6 mm	1/4"	1	
B-38934	50	8 mm	1/4"	1	
B-38940	50	10 mm	1/4"	1	
B-38956	50	12 mm	1/4"	1	
B-38962	50	13 mm	1/4"	1	
B-38978	50	17 mm	1/4"	1	
B-39154	50	6, 8, 10, 12, 13 mm	1/4"	5/1	
B-57554	50	8, 10, 12, 13 mm	1/4"	4/1	

# Pribor za vijačenje

121

## Votli natični ključ

Votli natični ključ skrajšajo čas privijanja matic na navojne palice v primerjavi z ročnim privijanjem.



Koda	Celotna dolžina (mm)	Dimenzija ključa	Vpetje	Cena z DDV
B-52526	75	10	1/4"	
B-52532	150	10	1/4"	
B-52548	300	10	1/4"	
B-52554	500	10	1/4"	
B-52560	700	10	1/4"	
B-52576	75	13	1/4"	
B-52582	150	13	1/4"	
B-52598	300	13	1/4"	
B-52607	500	13	1/4"	
B-52613	700	13	1/4"	
B-52629	75	17	1/4"	
B-52635	150	17	1/4"	
B-52641	300	17	1/4"	
B-52657	500	17	1/4"	
B-52663	700	17	1/4"	

## Natični ključ za navojne palice

Navojne palice so pogosto uporabljene za pritrjevanje klimatskih naprav, luči, cevi in kablov na strop ali na steno. Natični ključ za navojne palice znatno zmanjša čas in napor pri namestitvi navojnih palic v primerjavi z ročno namestitvijo.

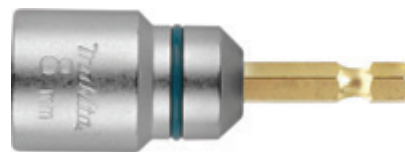

Koda	Naziv	Dolžina (mm)	Tip vijaka	Vpetje	Cena z DDV
B-42961	Natični ključ za navojne palice	66	M6	1/4"	
B-42977	Natični ključ za navojne palice	66	M8	1/4"	
B-42983	Natični ključ za navojne palice	66	M10	1/4"	

Akumulat  
orj in  
polnilniki

Pribor za  
akumulat  
orsko  
orodje

Akumulat  
orske  
svetilke  
in pribor

Pribor za  
lasarske  
merilnike

Pribor za  
rušenje  
in vrtanje

Pribor za  
vrtanje

Kronske  
žage

Pribor za  
vijačenje

Pribor za  
rezanje  
in  
brušenje

Pribor za  
poliranje  
in  
brušenje

Pribor za  
rezkanje  
in  
oblanje

Pribor za  
multifunk  
cjsko  
orodje

Pribor za  
žaganje

Pribor za  
žebjalnike  
in  
spenjalnike

Pribor za  
fene

Pribor za  
sesanje

Pribor  
orodja za  
uporabo  
na prostem

Pribor za  
pomoč je  
orodja in  
zaščitna  
oprema

Kovčki in  
torbe za  
orodje



Ročno  
orodje

Razno

Pribor za  
mešanje

## Seti

## Ostali pribor

	Koda	Naziv	Cena z DDV
	B-69917	Škatla za shranjevanje pribora	
	D-58833	Raglja z ročajem s PH2 vij.nastavkom	

## Pribor za vijačnike s podajnikom

## Phillips (PH) vijačni nastavki

Vijačniki s samodejnim podajanjem, ki so izdelani s serijsko številko, ki je prikazana na desni, uporabljajo 5 mm vijačne nastavke. To je dobro označeno tudi na ohišju naprave. Modeli, ki so bili izdelani pred temi serijskimi številkami pa uporabljajo 6 mm vijačne nastavke.



Koda	Celotna dolžina (mm)	Tip vijaka	Premer (Ø) (mm)	Vpetje	Za model	Enota (kos/set)	Cena z DDV
P-66232	117	PH2	5	1/4"	DFR440	10/1	
P-13568	127	PH2	6	1/4"	6832, 6833, 6835DWA	10/1	
P-67795	157	PH2	5	1/4"	6842, DFR550	3/1	
P-67804	177	PH2	5	1/4"	6844, DFR750	3/1	

## Pozidrive (PZ) vijačni nastavki

Vijačniki s samodejnim podajanjem, ki so izdelani s serijsko številko, ki je prikazana na desni, uporabljajo 5 mm vijačne nastavke. To je dobro označeno tudi na ohišju naprave. Modeli, ki so bili izdelani pred temi serijskimi številkami pa uporabljajo 6 mm vijačne nastavke.



Koda	Celotna dolžina (mm)	Tip vijaka	Premer (Ø) (mm)	Vpetje	Za model	Enota (kos/set)	Cena z DDV
P-66260	117	PZ2	5	1/4"	DFR440	10/1	
P-13580	127	PZ2	6	1/4"	6835DWA	10/1	
P-66276	127	PZ2	5	1/4"	6835DWA	10/1	
P-67773	157	PZ2	5	1/4"	6842, 6843, DFR540	3/1	
P-67789	177	PZ2	5	1/4"	DFR750	3/1	





## Hitromontažni vijaki na traku - PH2

Koda	Ø glave vijaka (mm)	Dolžina (mm)	Navoj ( )	Premaz ( )	Primerno za	Za model	Enota (kos/set)	Cena z DDV
F-30913	3,9	25	Fin	prevlečeni s fosfatom	Vezane plošče na kovinski profil	DFR550	1.000/1	
F-30926	3,9	30	Fin	prevlečeni s fosfatom	Vezane plošče na kovinski profil	DFR550	1.000/1	
F-30942	3,9	55	Fin	prevlečeni s fosfatom	Vezane plošče na kovinski profil	DFR550, DRF750	1.000/1	
F-31153	3,9	35	Fin	prevlečeni s fosfatom	vezane plošče in lesene konstrukcije	DFR550	1.000/1	
F-31179	3,9	35	Grob	prevlečeni s fosfatom	Vezane plošče na les	DFR550	1.000/1	
F-31182	3,9	41	Grob	prevlečeni s fosfatom	Vezane plošče na les	DFR550	1.000/1	
F-31201	4,2	40	Fin	prevlečeni s cinkom	Vezane plošče na les	DFR550	1.000/1	
P-13225	4,5	75	Grob	prevlečeni s fosfatom	Vezane plošče na les	DFR550	500/1	

## Podajalni mehanizem za vijake



Koda	Naziv	Dolžina vijakov (mm)	Za model	Cena z DDV
125537-7	Podajalni mehanizem za vijake	25-41	DFR440	
195184-8	Podajalni mehanizem za vijake	25-55	6842, 6843, DFR540, DFR550	

## Podajalni mehanizem za vijačnike in nastavki



Koda	Naziv	Dolžina vijakov (mm)	Tip vijaka	Za model	Enota (kos/set)	Cena z DDV
191L24-0	Podajalnik vijakov	25-55		DFS452, DFS250, FS6300, FS4300, FS4200, FS4000, FS2300	1	
191V01-2	Vijačni nastavek PH 137	137	PH2	DFR452	5/1	
191V02-0	Vijačni nastavek PH 155	155	PH2	DFR551	5/1	
191V03-8	Vijačni nastavek SQ 137	137	SQ2	DFR452	5/1	
191V04-6	Vijačni nastavek SQ 155	155	SQ2	DFR551	5/1	
191V05-4	Vijačni nastavek PZ 137	137	PZ2	DFR452	5/1	
191V06-2	Vijačni nastavek PZ 155	155	PZ2	DFR551	5/1	
191W93-7	Podajalnik vijakov 20-41mm	20-41		DFR452, DFR551	1	
191W94-5	Podajalnik vijakov 25-55mm	25-55		DFR452, DFR551	1	

[Nadaljevanje...](#)

Akumulatorji in polnilniki

Pribor za akumulatorsko orodje

Akumulatorske svetilke in pribor

Pribor za laserske merilnike

Pribor za rušenje in vrtanje

Pribor za vrtanje

Kronske žage

Pribor za vijačenje

Pribor za rezanje in brušenje

Pribor za poliranje in brušenje

Pribor za rezkanje in oblanje

Pribor za multitank cijsko orodje

Pribor za žaganje

Pribor za žebjalnike in spenjalnike

Pribor za fene

Pribor za sesanje

Pribor orodja za uporabo na prostem

Pribor za ročno orodje in zaščita oprema

Kovčki in torbe za orodje

Ročno orodje

Razno

Pribor za mešanje

# Pribor za vijačenje

Koda	Naziv	Dolžina vijakov (mm)	Tip vijaka	Za model	Enota (kos/set)	Cena z DDV
199155-7	Vijačni nastavek PH2 za podajalnik DFS	130	PH2	DFS452, DFS451, DFS250, FS6300, FS6200, FS4300, FS4200, FS4000, FS2300, FS2200	5/1	
199156-5	Vijačni nastavek SQ2 za podajalnik DFS	130	SQ2	DFS452, DFS451, DFS250, FS6300, FS6200, FS4300, FS4200, FS4000, FS2300, FS2200	5/1	

## Podaljški z ročajem

Dolžina podaljška je nastavljiva med 600 in 700 mm (celotna dolžina z nameščeno napravo je od 890 do 990 mm).



Koda	Za model	Cena z DDV
194500-1	6840, 6841, 6841R, 6842, 6843, 6844, 6845, DFR440, DFR540, DFR550, DFR750	

## Nastavki za centriranje

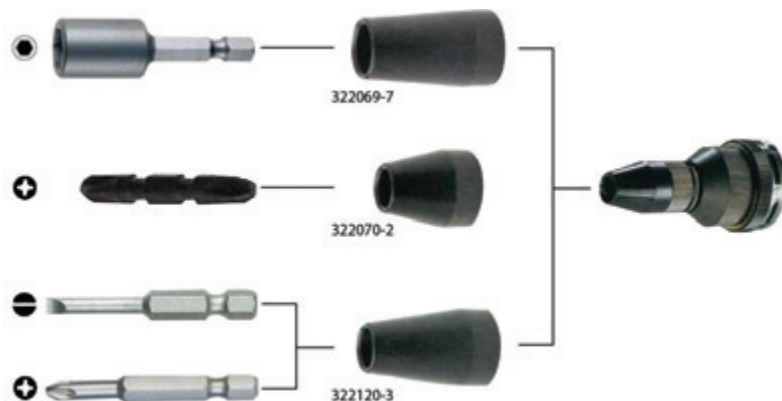

	Koda	Opis	Za model	Cena z DDV
	197024-6	Omejevalnik globine na težko dostopnih mestih za 76 mm držalo vijačnih nastavkov	DFS452, DFS451, FS2300, FS4000, FS4300, FS6300R	
	197025-4	Omejevalnik globine na težko dostopnih mestih za 60 mm držalo vijačnih nastavkov	DFS452, DFS451, FS2300, FS4000, FS4300, FS6300R	
	322069-7	Nastavek za centriranje za natične ključne (Φ 15,5 mm x 45 mm)	6827, FS2700	
	322070-2	Nastavek za centriranje, za 45 mm vijačne nastavke (Φ 12 mm x 30 mm)	6827, FS2700	
	322120-3	Nastavek za centriranje, za 50 mm vijačne nastavke (Φ 12 mm x 42 mm)	6805BV, 6827, FS2700	

# Pribor za vijačenje

125

## Pribor za udarne vijačnike



### Natični ključi Cr-Mo z O-tesnilom 1"



Koda	Celotna dolžina (mm)	Dimenzija ključa	Tip vijaka	Vpetje	Cena z DDV
134864-1	80	35	7/8"	1"	
134865-9	80	36	M24	1"	
134872-2	80	41	M27	1"	



### Natični ključi Cr-Mo z O-tesnilom 1/2"

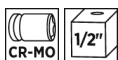

Koda	Celotna dolžina (mm)	Dimenzija ključa	Tip vijaka	Vpetje	Cena z DDV
134825-1	38	13	M8	1/2"	
134827-7	52	13	M8	1/2"	
134829-3	38	17	M10	1/2"	
134830-8	52	17	M10	1/2"	
134831-6	38	19	M12	1/2"	
134832-4	52	19	M12	1/2"	
134833-2	52	21	M14	1/2"	
134838-2	38	21	M14	1/2"	
134834-0	52	22	M14	1/2"	
134851-0	38	22	M14	1/2"	
134835-8	52	23	M14	1/2"	
134836-6	52	24	M16	1/2"	
134841-3	45	24	M16	1/2"	
134844-7	50	27	M18	1/2"	
134845-5	78	27	M18	1/2"	
134846-3	50	30	M20	1/2"	
134847-1	78	30	M20	1/2"	
134848-9	50	32	M22	1/2"	
134849-7	78	32	M22	1/2"	

Akumulat orji in polnilniki  
 Pribor za akumulat orsko orodje  
 Akumulat orske svetilke in pribor  
 Pribor za lasarske merilnike  
 Pribor za rušenje in vrtanje  
 Pribor za vrtanje  
 Kronske žage  
 Pribor za vijačenje  
 Pribor za rezanje in brušenje  
 Pribor za poliranje in brušenje  
 Pribor za rezkanje in oblanje  
 Pribor za multitfunkcijsko orodje  
 Pribor za žaganje  
 Pribor za žebjalnike in spenjalnike  
 Pribor za fene  
 Pribor za sesanje  
 Pribor orodja za uporabo na prostem  
 Pribor za ročno orodje in zaščitna oprema  
 Kovčki in torbe za orodje  
 Ročno orodje  
 Razno  
 Pribor za mešanje



### Natični ključni Cr-Mo z O-tesnilom 3/4"

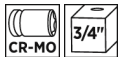

Koda	Celotna dolžina (mm)	Dimenzija ključa	Tip vijaka	Vpetje	Cena z DDV
A-85494	50	17	M10	3/4"	
A-85519	50	19	M12	3/4"	
A-85553	52	22	M14	3/4"	
A-85575	52	24	M16	3/4"	
134853-6	52	26	M16	3/4"	
134854-4	95	26	M16	3/4"	
134855-2	52	27	M18	3/4"	
134857-8	52	30	M20	3/4"	
134858-6	95	30	M20	3/4"	
134859-4	95	32	M22	3/4"	
134871-4	52	32	M22	3/4"	
134861-7	95	35	7/8"	3/4"	
134862-5	56	36	M24	3/4"	
134863-3	95	36	M24	3/4"	



### Natični ključni Cr-Mo brez O-tesnila 3/8"

Za udarne vijačnike s kvadratnim vpetjem 3/8". Natični ključ je namenjen za uporabo z električnimi in akumulatorskimi udarnimi vijačniki. Ključ je izdelan iz izjemno vzdržljivega Cr-Mo (krom molibden) materiala in je odporen na visoke momente. Oznaka "Cr-Mo" je lasersko navarjena na zunanji strani natičnega ključa.

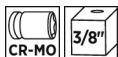

Koda	Celotna dolžina (mm)	Dimenzija ključa	Vpetje	Cena z DDV
B-39883	28	6	3/8"	
B-39899	28	7	3/8"	
B-39908	28	8	3/8"	
B-39914	28	9	3/8"	
B-39920	28	10	3/8"	
B-39936	28	11	3/8"	
B-39942	28	12	3/8"	
B-39958	28	13	3/8"	
B-39964	28	14	3/8"	
B-39970	28	15	3/8"	
B-39986	28	16	3/8"	
B-39992	30	17	3/8"	
B-40004	30	18	3/8"	
B-40010	30	19	3/8"	
B-40026	30	20	3/8"	
B-40032	30	21	3/8"	

[Nadaljevanje...](#)



# Pribor za vijačenje

Koda	Celotna dolžina (mm)	Dimenzija ključa	Vpetje	Cena z DDV
B-40048	30	22	3/8"	



## Natični ključi Cr-Mo brez tesnila 3/8" dolgi



Koda	Celotna dolžina (mm)	Dimenzija ključa	Vpetje	Cena z DDV
B-55398	63	7	3/8"	
B-55407	63	8	3/8"	
B-55413	63	9	3/8"	
B-55429	63	10	3/8"	
B-55435	63	11	3/8"	
B-55441	63	12	3/8"	
B-55457	63	13	3/8"	
B-55463	63	14	3/8"	
B-55479	63	15	3/8"	
B-55485	63	16	3/8"	
B-55491	63	17	3/8"	
B-55500	63	18	3/8"	
B-55516	63	19	3/8"	
B-55522	63	20	3/8"	
B-55538	63	21	3/8"	
B-55544	63	22	3/8"	



## Seti natičnih ključev

Omogoča zatezanje in odvijanje vijakov in matic.

Koda	Naziv	Dimenzija ključa	Vpetje	Cena z DDV
B-54645	9-delni set natičnih nastavkov 1/2" z adapterjem	8, 10, 12, 13, 14, 15, 17, 18 mm	1/2"	
B-55550	Set natičnih ključev	63 mm; 8, 9, 10, 11, 12, 13, 14, 15, 16, 17, 18, 19, 21, 22 mm	3/8"	
B-66232	9 delni set nasadnih ključev	8, 10, 12, 13, 14, 16, 17, 19, 21mm	1/2"	



Nadaljevanje...

Akumulat orji in polnilniki

Pribor za akumulat orsko orodje

Akumulat orske svetilke in pribor

Pribor za lasarske merilnike

Pribor za rušenje in vrtanje

Pribor za vrtanje

Kronske žage

Pribor za vijačenje

Pribor za rezanje in brušenje

Pribor za poliranje in brušenje

Pribor za rezkanje in oblanje

Pribor za multitfunkcijsko orodje

Pribor za žaganje

Pribor za žebjalnike in spenjalnike

Pribor za fene

Pribor za sesanje

Pribor za orodja za uporabo na prostem

Pribor za ploščice in zaščitna oprema





Kovčki in torbe za orodje

Ročno orodje

Razno

Pribor za mešanje

# Pribor za vijačenje

	Koda	Naziv	Dimenzija ključa	Vpetje	Cena z DDV
	B-69733	7-delni set natičnih ključev z adapterjem v plastični škatli	13, 17, 19, 21, 22, 24 mm	1/2"	
	B-69749	9-delni set natičnih ključev v tekstilnem ovitku	10, 11, 13, 17, 19, 21, 22, 24, 27 mm	1/2"	
	E-02989	8-delni set natičnih nastavkov v torbici	8, 10, 12, 13, 14, 17, 19, 21 mm	1/2"	
	E-12289	8-delni set natičnih nastavkov z adapterjem	6, 7, 8, 10, 11, 12, 13 mm	1/4"	
	E-12354	3-delni set 1/2 natičnih ključev za platišča	86mm: 17, 19, 21mm	1/2"	

## Podaljški in adapterji

	Koda	Naziv	Celotna dolžina (mm)	Vpetje	Cena z DDV
	134870-6	Podaljševalna ročica	200	1"	
	134873-0	Adapter 1/2" na 1/4"	50	1/2"	
	134874-8	Podaljševalna ročica	100	1/2"	
	134877-2	Pregibni nastavek	84	1/2"	
	134997-2	Podaljševalna ročica	150	3/4"	
	191G67-2	Podaljšana ročaj za akumulatorske udarne vijačnike	657-807	/	
	195870-1	Nastavek za izvlek SDS-MAX svredrov za udarni vijačnik	160	1/2"	
	B-54570	O-tesnilo za natične ključe 1/2 (3kos/pk)	/	1/2"	

[Nadaljevanje...](#)

# Pribor za vijačenje

129

Koda	Naziv	Celotna dolžina (mm)	Vpetje	Cena z DDV	
B-54617	Zatič za 1/2 natične ključe(3kos/pk)	/	1/2"		
B-54673	Adapter za SQ1/2 natične ključe	50	1/4" hex		
B-55706	Podaljševalna ročica, SQ1/2, 250 mm	250	1/2"		
B-55712	Podaljševalna ročica, SQ1/2, 150 mm	150	1/2"		
B-55728	Podaljševalna ročica, SQ1/2, 75 mm	75	1/2"		
B-68448	Adapter 1/2" na 1/4" Hex	51	1/2"		
P-05941	Aadapter 1/2" na 1/4"	50	1/2"		
P-05963	Adapter 3/8" na 1/4"	55	3/8"		
P-21559	O-lesnilo za adapter P-05941	/	1/2"		
P-21565	Varnostni zatič za adapter P-05941	/	1/2"		

Akumulat  
orji in  
poinliniki

Pribor za  
akumulat  
orsko  
oročje

Akumulat  
orske  
svetilke  
in pribor

Pribor za  
lasarske  
merilnike

Pribor za  
rušenje  
in vrtanje

Pribor za  
vrtanje

Kronske  
žage

Pribor za  
vijačenje

Pribor za  
rezanje  
in  
brušenje

Pribor za  
poliranje  
in  
brušenje

Pribor za  
rezkanje  
in  
oblanje

Pribor za  
multifunk  
ciljsko  
oročje

Pribor za  
žaganje

Pribor za  
žabljalnike  
in  
spenjalnike

Pribor za  
fene

Pribor za  
sesanje

Pribor  
oročja za  
uporabo  
na prostem

Pribor za  
pomoč je  
oročja in  
zaščitna  
oprema





























Kovčki in  
torbe za  
oročje

Ročno  
oročje

Razno  
oročje

Pribor za  
mešanje

# PRIBOR ZA REZANJE IN BRUŠENJE

Marmor		Naravni kamen	
Beton		Armiran beton	
Apnenec		Modularna opeka	
Opeka		Porozna opeka	
Steklo		Opečna kritina	
Asfalt		Mehki skrilavec	
Aluminij		Steklena vlakna	
Kovine		Nerjavno jeklo	
Les		Barvne kovine	
Granit		Plastika, PVC	
		Epoksi	
		Keramične ploščice	
		Odstranjevanje barve	
		Zaključna dela	
		Aluminijev oksid	
		Aluminijev oksid s keramiko	
		Cirkonij	
		Za mokro rezanje	
		Za suho rezanje	
		Akumulatorski kotni brusilnik	
		Industrija - ladjedelnica	
		Industrija - naftna ploščad	
		Upogljiva plošča	
		Tanka plošča	
		Podporna podloga	
		Varnost	
		Dolga življenjska doba	





Količina dela z eno napolnjenostjo baterije



### TANKE REZALNE PLOŠČE

Debeline 0,8 mm za hitro rezanje.

#### Tanjša debelina

Debelina 0,8 mm, nam omogoča hitro rezanje, zmanjšanje rezalnega upora, manj odpada pri rezanju in manj prašenja.



Standardno  
(1,0 mm debeline)



100

20%  
več



Popolno za  
akumulatorsko orodje  
(0,8 mm debeline)



120



### UPOGLJIVE BRUSILNE PLOŠČE

Nizke vibracije in brez uporabe podpornih krožnikov.

#### Anti-vibracijska struktura

Dodan je material, ki pomaga pri absorbiranju vibracij. Zaradi upogljivosti je hitrost brušenja višja, večja pa je tudi stična površina z obdelovancem.



Standardno  
(115 x 6 mm debeline)



100

70%  
več



Popolno za  
akumulatorsko orodje  
(115 x 4 mm)



170

Za ploščice



### TANKE DIAMANTNE PLOŠČE

Gladko rezanje brez napora.

#### Kljub tanjši debelini dovolj moči

Debelina 1,4 mm omogoča čisto rezanje z zelo malo napora.

Valoviti rob zmanjša vibracije in poveča pobiranje materiala med rezanjem.



Standardno  
(2,3 mm debeline)



100

60%  
več

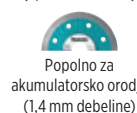

Popolno za  
akumulatorsko orodje  
(1,4 mm debeline)



160

Za beton / kamen

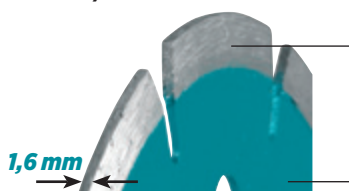

### Posebno rezanje

Te plošče so zasnovane kot 1,6 mm, zato rezanje poteka gladko in brez napora.

Z luknjanjem je dosežena manjša teža plošče, posledično pa je manjša tudi obremenitev orodja in baterije. Povečana je količina opravljenega dela z eno napolnjenostjo baterije.



Standardno  
(2,2 mm debeline)



100

50%  
več



Popolno za  
akumulatorsko orodje  
(1,6 mm debeline)



150

## X LOCK

Diamantne plošče z robom iz volframovega karbida

Tanke rezalne plošče

Diamantne plošče

Brusilne plošče

Žične krtače



### HITRA MENJAVA

Skrajšan čas menjave plošč.



### MENJAVA BREZ ORODJA

Enostaven "klik" sistem, brez uporabe dodatnih orodij.



Količina dela z eno napolnjenostjo baterije

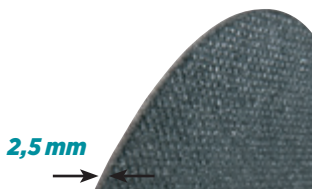

### ABRAZIVNE REZNE PLOŠČE ZA KOVINO

Izdelane posebej za akumulatorske stabilne žage.

#### Tanjše plošče z optimalnim vezivom

2,5 mm debele plošče za gladko in hitro rezanje. Optimalno vezivo poskrbi za hitre, čiste reze in daljšo življenjsko dobo plošč.



Standardno  
(3,0 mm debeline)



100

50%  
več



Popolno za  
akumulatorsko orodje  
(2,5 mm debeline)



150



# DIAMANTNE REZALNE PLOŠČE



**QUASAR**

Univerzalne profesionalne 3DDG diamantne rezalne plošče. Ponašajo se z Stealth tehnologijo za manj vibracij in nižji hrup. Hitri in čisti rezi. Za suho in mokro rezanje.



**COMET**

Polprofesionalne 3DDG diamantne rezalne plošče. Del segmenta ima Stealth tehnologijo za manj vibracij in nižji hrup. Hitri in čisti rezi.

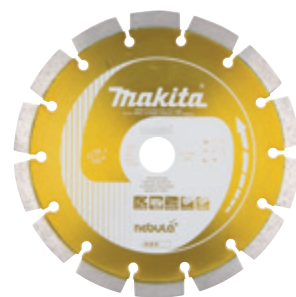

**NEBULA**

3DDG diamantne rezalne plošče z lasersko varjenimi segmenti. Za suho in mokro rezanje.



### 3DDG TEHNOLOGIJA

Za hitrejšo rezanje in daljšo življenjsko dobo

Napredna tehnologija izdelave omogoča enakomerno in vzporedno 3-dimenzionalno porazdelitev delcev diamantov po točno določenem vzorcu za daljšo življenjsko dobo in hitrejšo obdelovalno hitrosti.



### STEALTH TEHNOLOGIJA

Za nižje vibracije in tiho delovanje

Inovativna tehnologija ki zmanjšuje resonanco in glasnost pri delu. To je še posebej pomembno pri delu v naseljih, kjer je zaželeno čim manjša stopnja hrupa. Stabilna rezila, ki omogočajo hitro in gladko rezanje.

MATERIALI	QUASAR	COMET	NEBULA
Granit	◆◆	◆◆	◆
Trde klinker opeke	◆◆	◆◆	◆
Trde glinene opeke	◆◆◆◆	◆◆◆◆	◆
Tlakovci	◆◆◆◆	◆◆◆◆	◆
Glinene cevi	◆◆◆◆◆	◆◆◆◆◆	◆
Trdi kamen	◆◆◆◆◆	◆◆◆◆◆	◆
Glineni strešniki	◆◆◆◆◆	◆◆◆◆◆	◆
Srednje trdi kamni	◆◆◆◆◆	◆◆◆◆◆	◆◆
Trdi skrilavec	◆◆◆◆◆	◆◆◆◆◆	◆◆
Teraco plošče	◆◆◆◆◆	◆◆◆◆◆	◆◆
Armirani beton	◆◆◆◆◆	◆◆◆◆◆	◆◆◆◆
Apnec	◆◆◆◆◆	◆◆◆◆◆	◆◆◆◆
Betonski T-nosilec	◆◆◆◆◆	◆◆◆◆◆	◆◆◆◆
Betonski robnik	◆◆◆◆◆	◆◆◆◆◆	◆◆◆◆
Prane betonske plošče	◆◆◆◆◆	◆◆◆◆	◆◆◆◆
Betonske police	◆◆◆◆◆	◆◆◆◆	◆◆◆◆
Betonska opeka	◆◆◆◆◆	◆◆◆◆	◆◆◆◆
Mehki kamni	◆◆◆◆◆	◆◆	◆◆
Mehki skrilavec	◆◆◆◆◆	◆◆	◆◆
Betonski strešniki	◆◆◆◆	◆◆	◆◆
Trd peščenjak	◆◆◆◆	◆	◆
Mehki peščenjak	◆◆	◆	◆
Estrih	◆◆	◆	◆
Asfalt	◆◆	◆	◆

## POMEN OZNAK

Vrsta plošče: Q: Quasar C: Comet N: Nebula L: Laser

Vrsta roba: DS: Diamond Segment DC: Diamond Continuous DA: Diamond Asphalt

Premer plošče (mm): 300

Premer luknje (mm): 22

Posebnosti: C: z luknjami za hlajenje V: z debelejšim srednjim delom plošče X: 3D-Diamantna struktura S: Stealth tehnologija

**Q DS 300 22 XS**

## DIAMANTNE REZALNE PLOŠČE

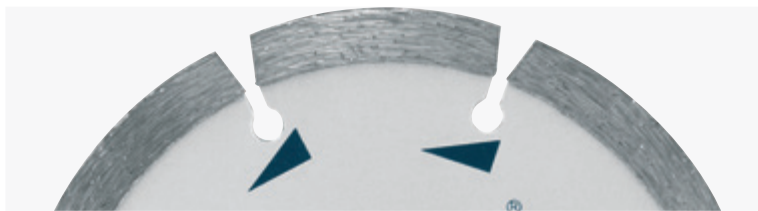

### S SEGMENTNIM ROBOM:

Plošče imajo zareze, diamantni delci pa so nameščeni v segmentih. Diamantne rezalne plošče s segmentnim robom režejo hitreje od običajnih in dosegaajo povprečno kvaliteto odrezane površine.



### S SEGMENTNIM VALOVITIM ROBOM:

Plošče imajo zareze z valovi kar omogoča hitrejšo rezanje z manj upora in izboljšano odvajanje materiala.

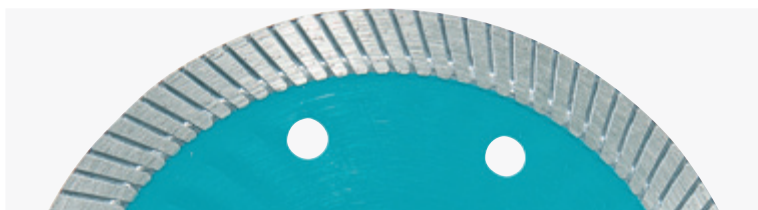

### Z VALOVITIM ROBOM:

Rezalna plošča ima zareze okoli robu. Karakteristika delovanja je med rezalnimi ploščami s segmentnim robom in ploščami z gladkim robom. Hitrejšo rezanje kot pri segmentnih rezalnih ploščah. Možnost doseganja čistejših rezov v primerjavi z rezalnimi ploščami z gladkim robom brez deljenih robov.



### Z GLADKIM ROBOM:

Plast diamantnih delcev s konstantno debelino je nanesena po celotnem robu plošče. Možnost izdelave gladkih in čistih rezov tudi pri rezanju krhkih materialov. Bolj natančno rezanje pri nižji hitrosti v primerjavi s segmentnimi rezalnimi ploščami.

## DIAMANTNE REZALNE PLOŠČE - SPECIALIZED



### ROB Z GALVANSKO NANESENIMI DELCI:

Diamantni delci so nameščeni z elektrodami in so zato bolj izpostavljeni, kot pri običajnem nanašanju. Omogočajo hitrejšo rezanje in večjo učinkovitost.



### ROB Z VAKUUMSKO NANESENIMI DIAMANTNIMI DELCI:

Diamantni delci so vakuumsko naneseni, ter so zato bolj izpostavljeni, kot pri običajnem nanašanju. Rezalne plošče proizvedene s to metodo imajo daljšo življenjsko dobo od teh z galvansko nanesenimi delci. Namenjene so za rezanje trdih materialov.

## KAKOVOSTNI RAZREDI

### VISOKOKVALITETNE PLOŠČE

★★★

Najvišja zmogljivost in razmerje med rezalno hitrostjo in vzdržljivostjo.

### STANDARDNE PLOŠČE

★★

Odlično razmerje med zmogljivostjo in ceno.

### EKONOMIČNE PLOŠČE

★

Izjemno privlačne zaradi nizke cene.

## Diamantne rezalne plošče

## Quasar Stealth, 3DDG

Premium rezalne plošče s 3D razporeditvijo diamantnih delcev (3DDG) za profesionalno uporabo. Quasar segmentne rezalne plošče imajo 'M' obliko segmentov z uporabno dolžino 12 mm. Na voljo s Stealth tehnologijo za zmanjševanje hrupa in vibracij, z debelejšim srednjim delom plošče. Lasersko varjene, primerne za suho in mokro uporabo. Za rezanje: marmorja, granita, armiranega betona, betona, srednje trde in trde opeke, kamnitih plošč, keramičnih ploščic in skrilavca.

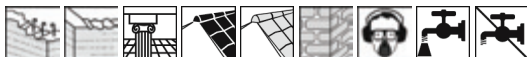

Koda	Makita ID koda	Diamantna plošča (Ø) (mm)	Luknja diamantne plošče (Ø) (mm)	Višina segmenta (mm)	Opis	Največje število obratov (min <sup>-1</sup> )	Cena z DDV
B-12712	QDS23022XS	230	22,23	12	3DDG, Stealth	6.650	
B-13459	QDS30020XS	300	20	12	3DDG, Stealth	6.400	
B-17588	QDS30025XS	300	25,4	12	3DDG, Stealth	6.400	
B-13465	QDS35025XS	350	25,4/20	12	3DDG, Stealth	5.500	
B-13471	QDS40025XS	400	25,4/20	12	3DDG, Stealth	4.770	

## Comet Universal s hladilnimi luknjami, 3DDG

Široka izbira kvalitetnih rezalnih plošč s 3D tehnologijo (3DDG) mrežic in z dodatnimi posebnostmi, kot je tehnologija za mirno delovanje in luknje za hlajenje. Lasersko varjene za suho in mokro uporabo. Primerne za rezanje betona, srednje trde/trde opeke, teraca, glinenih ploščic, skrilavca in glinenih izdelkov.

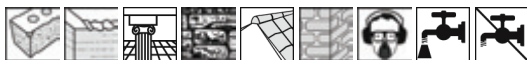

Koda	Makita ID koda	Diamantna plošča (Ø) (mm)	Luknja diamantne plošče (Ø) (mm)	Višina segmenta (mm)	Opis	Največje število obratov (min <sup>-1</sup> )	Cena z DDV
B-12762	CDS11522RC	115	22,23	10	3DDG, hladilne luknje	13.300	
B-12778	CDS12522RC	125	22,23/20	10	3DDG, hladilne luknje	12.250	
B-27187	CDS15022RC	150	22,23	10	3DDG, hladilne luknje	10.200	
B-27193	CDS18022RC	180	22,23	10	3DDG, hladilne luknje	8.500	
B-12784	CDS23022RCX	230	22,23	10	3DDG, hladilne luknje	6.650	
B-13546	CDS30020RCX	300	20	10	3DDG, hladilne luknje	6.400	
B-17619	CDS30025RC	300	25,4	10	3DDG, hladilne luknje	6.400	
B-13552	CDS35025RCX	350	25,4/20	10	3DDG, hladilne luknje	5.550	
B-13568	CDS40025RCX	400	25,4/20	10	3DDG, hladilne luknje	4.800	

# Pribor za rezanje in brušenje

135



## Comet Turbo



comet

Koda	Makita ID koda	Diamantna plošča (Ø) (mm)	Luknja diamantne plošče (Ø) (mm)	Višina segmenta (mm)	Opis	Cena z DDV
B-12980	CTD11522	115	22,23	7	Turbo rob	
B-12996	CTD12522	125	22,23/20	7	Turbo rob	
B-13007	CTD15022	150	22,23/20	7	Turbo rob	
B-13013	CTD17522	175	22,23	7	Turbo rob	
B-13029	CTD20030	200	30/25,4	7	Turbo rob	
B-13035	CTD23022	230	22,23	8	Turbo rob	
B-13041	CTD30025	300	25,4	8,5	Turbo rob	
B-13057	CTD35025	350	25,4	8,5	Turbo rob	



## Comet Asphalt, 3DDG

Plošče imajo zarezane, diamantni delci pa so nameščeni v segmentih. Diamantne rezalne plošče s segmentnim robom režejo hitreje od običajnih in dosegajo povprečno kvaliteto odrezane površine. Za rezanje: asfalta, abrazivnega apnenca, peščenjaka, brusnega kamna in mehkih blokov.



comet

Koda	Makita ID koda	Diamantna plošča (Ø) (mm)	Luknja diamantne plošče (Ø) (mm)	Višina segmenta (mm)	Opis	Največje število obratov (min <sup>-1</sup> )	Cena z DDV
B-13269	CDA30020	300	20	10	3DDG, Asfalt	6.360	
B-13275	CDA35025	350	25,4/20	10	3DDG, Asfalt	5.500	
B-42905	CDA40025	400	25,4/20	10	3DDG, Asfalt	4.800	

## Comet z gladkim robom

Plast diamantnih delcev s konstantno debelino je nanešana po celotnem robu plošče. Možnost izdelave gladkih in čistih rezov tudi pri rezanju krhkih materialov. Bolj natančno rezanje pri nižji hitrosti v primerjavi s segmentnimi rezalnimi ploščami. Za rezanje: keramičnih ploščic in porcelana.



comet

Koda	Makita ID koda	Diamantna plošča (Ø) (mm)	Luknja diamantne plošče (Ø) (mm)	Višina segmenta (mm)	Opis	Cena z DDV
B-13063	CDC8015	80	15	5	Gladek rob	
B-13085	CDC11522	115	22,23	5	Gladek rob	
B-13091	CDC12522	125	22,23	5	Gladek rob	

[Nadaljevanje...](#)

Akumulat orji in polnilniki  
Pribor za akumulat orsko orodje  
Akumulat orske svetilke in pribor  
Pribor za laserske merilnike  
Pribor za rušenje in vrtanje  
Pribor za vrtanje  
Kronске žage  
Pribor za vijačenje  
Pribor za rezanje in brušenje  
Pribor za poliranje in brušenje  
Pribor za rezkanje in oblanje  
Pribor za multitank orodje  
Pribor za zaganje  
Pribor za žebjalnike in spenjalnike  
Pribor za fene  
Pribor za sesanje  
Pribor orodja za uporabo na prostem  
Pribor za ploščice in zaščitna oprema  
Kovčki in torbe za orodje  
Ročno orodje  
Razno  
Pribor za mešanje

# Pribor za rezanje in brušenje

Koda	Makita ID koda	Diamantna plošča (Ø) (mm)	Luknja diamantne plošče (Ø) (mm)	Višina segmenta (mm)	Opis	Cena z DDV
B-13100	CDC15022	150	22,23/20	5	Gladek rob	
B-13116	CDC17522	180	22,23	5	Gladek rob	
B-13122	CDC20030	200	30/25,4	5	Gladek rob	
B-13138	CDC23030	230	30/25,4	5	Gladek rob	
B-13144	CDC30025	300	25,4	7	Gladek rob	
B-13150	CDC35030	350	30/25,4	7	Gladek rob	

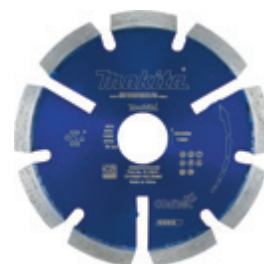

## Comet za čiščenje fug

Diamantna rezalna plošča za čiščenje fug

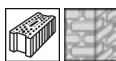

Koda	Makita ID koda	Diamantna plošča (Ø) (mm)	Luknja diamantne plošče (Ø) (mm)	Višina segmenta (mm)	Širina segmenta (mm)	Opis	Največje število obratov (min <sup>-1</sup> )	Cena z DDV
B-13247	CDM11522	115	22,23	6,5	6,4	segmentni rob	13.300	
B-13253	CDM12522	125	22,23	6,5	6,4	segmentni rob	12.250	



## Comet z robom z galvansko nanešenimi delci

Diamantni delci so nameščeni z elektrodami in so zato bolj izpostavljeni, kot pri običajnem nanašanju. Omogočajo hitrejšo rezanje in večjo učinkovitost. Za rezanje: marmorja, steklenih vlaken, vezane plošče in stekleno-plastičnih materialov.

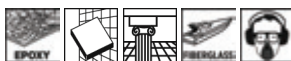

Koda	Makita ID koda	Diamantna plošča (Ø) (mm)	Luknja diamantne plošče (Ø) (mm)	Opis	Največje število obratov (min <sup>-1</sup> )	Cena z DDV
B-13172	CDE11522	115	22,23	Galvansko nanešen rob	13.300	
B-13188	CDE12522	125	22,23/20	Galvansko nanešen rob	12.250	
B-13194	CDE15022	150	22,23/20	Galvansko nanešen rob	10.200	
B-13203	CDE17522	175	22,23	Galvansko nanešen rob	8.500	
B-13219	CDE23022	230	22,23	Galvansko nanešen rob	6.650	
B-13225	CDE25022	250	22,23	Galvansko nanešen rob	15.300	





## Nebula z lasersko varjenim robom

Primerne za suho in mokro uporabo. Za rezanje gradbenih materialov (zid, beton, kremen, apnenec). Primerne tudi za uporabo z motornimi rezalniki.



Koda	Diamantna plošča (Ø) (mm)	Luknja diamantne plošče (Ø) (mm)	Višina segmenta (mm)	Opis	Cena z DDV
B-53986	115	22,23	10	Lasersko varjen rob	
B-53992	125	22,23	10	Lasersko varjen rob	
B-54003	150	22,23	10	Lasersko varjen rob	
B-54019	180	22,23	10	Lasersko varjen rob	
B-54025	230	22,23	10	Lasersko varjen rob	
B-54031	300	20	10	Lasersko varjen rob	
B-54047	300	20	10	Lasersko varjen rob	
B-54053	350	25,4	10	Lasersko varjen rob	
B-54069	400	25,4	10	Lasersko varjen rob	
B-54075	450	25,4	10	Lasersko varjen rob	

## Diamantne plošče za reševanje - rob z vakuumsko nanešenimi diamantnimi delci

Površina je prekrita z velikimi diamantnimi delci, ki omogočajo rezanje trdih materialov. Te večnamenske diamantne rezalne plošče so namenjene rezanju različnih materialov, na primer kovine, betona, smole, lesa, plastike in kaljenega stekla. Diamantni delci so neposredno spajkani na osnovno kovino. Primerno za brusilnike ali rezalnike.



Koda	Diamantna plošča (Ø) (mm)	Luknja diamantne plošče (Ø) (mm)	Debelina reza (mm)	Največje število obratov (min <sup>-1</sup> )	Opis	Primerno za	Cena z DDV
B-55304	115	22,23	2,8	13.300	rob z vakuumsko nanešenimi diamantnimi delci	kovino, beton, smolo, les, plastiko, kaljeno steklo	
B-55310	125	22,23	2,8	12.250	rob z vakuumsko nanešenimi diamantnimi delci	kovino, beton, smolo, les, plastiko, kaljeno steklo	
B-55326	230	22,23	3,1	6.650	rob z vakuumsko nanešenimi diamantnimi delci	kovino, beton, smolo, les, plastiko, kaljeno steklo	
B-55332	300	25,4	3,4	6.400	rob z vakuumsko nanešenimi diamantnimi delci	kovino, beton, smolo, les, plastiko, kaljeno steklo	
B-55348	355	25,4	3,4	5.500	rob z vakuumsko nanešenimi diamantnimi delci	kovino, beton, smolo, les, plastiko, kaljeno steklo	

 Akumulat  
orji in  
poinliniki

 Pribor za  
akumulat  
orsko  
orodje

 Akumulat  
orske  
svetilke  
in pribor

 Pribor za  
laserske  
merilnike

 Pribor za  
brušenje  
in vrtanje

 Pribor za  
vrtanje

 Kronske  
žage

 Pribor za  
vijačenje

 Pribor za  
rezanje  
in  
brušenje

 Pribor za  
poliranje  
in  
brušenje

 Pribor za  
rezkanje  
in  
oblanje

 Pribor za  
multifunk  
cjsko  
orodje

 Pribor za  
žaganje

 Pribor za  
žebjalnike  
in  
spenjalnike

 Pribor za  
fene

 Pribor za  
sesanje

 Pribor  
orodja za  
uporabo  
na prostem

 Pribor za  
plošče  
in  
zaščitna  
oprema

 Kovčki in  
torbe za  
orodje

 Ročno  
orodje

Razno

 Pribor za  
mešanje



## Diamantne plošče Specialized - rob z vakumsko nanešenimi diamantnimi delci



Koda	Diamantna plošča (Ø) (mm)	Luknja diamantne plošče (Ø) (mm)	Višina segmenta (mm)	Debelina rezila (mm)	Največje število obratov (min <sup>-1</sup> )	Opis	Primerno za	Cena z DDV
B-53693	125	22,23	1,5	1,3	12.250	rob z vakuumsko nanešenimi diamantnimi delci	kovina	
B-53718	230	22,23	1,5	1,3	6.650	rob z vakuumsko nanešenimi diamantnimi delci	kovina	



## Diamantne plošče z robom iz volframovega karbida

Lasersko varjen rob iz volframovega karbida omogoča višjo hitrost in daljšo življensko dobo. Rezalna plošča z robom iz volframovega karbida za rezanje s kotnim brusilnikom. Možnost rezanja mavčnih plošč, PVC-ja, FRP plošč NI NAMENJENO REZANJU LESA. Pri rezanju lesa obstaja veliko tveganje povratnega udarca, ki lahko privede do poškodb.

Koda	Diamantna plošča (Ø) (mm)	Luknja diamantne plošče (Ø) (mm)	Največje število obratov (min <sup>-1</sup> )	Primerno za	Za model	Cena z DDV
B-57716	115	22,23	13.300	PVC, mavčne plošče, FRP plošče, materiali iz vlaken	115 mm kotni brusilniki	
B-57722	125	22,23	12.250	PVC, mavčne plošče, FRP plošče, materiali iz vlaken	125 mm kotni brusilniki	



## Diamantne plošče za suho rezanje - segmentne



Koda	Diamantna plošča (Ø) (mm)	Luknja diamantne plošče (Ø) (mm)	Višina segmenta (mm)	Debelina rezila (mm)	Največje število obratov (min <sup>-1</sup> )	Opis	Primerno za	Cena z DDV
A-84109	115	22,23	7	1,9	13.300	segmentni rob	beton	
B-53780	115	22,23	7	1,6	13.300	segmentni rob	granit, beton, marmor	
D-52750	115	22,23	7	1,8	13.300	segmentni rob	beton, marmor	
A-84115	125	22,23	7	1,9	12.200	segmentni rob	beton, marmor	
B-53796	125	22,23	7	1,6	12.250	segmentni rob	granit, beton, marmor	
D-41595	125	22,23	7	2,2	12.250	segmentni rob	beton	
D-52766	125	22,23	7	1,8	12.250	segmentni rob	beton, marmor	
B-06432	150	22,23	7	2,1	10.200	segmentni rob	beton	

[Nadaljevanje...](#)

# Pribor za rezanje in brušenje

Koda	Diamantna plošča (Ø) (mm)	Luknja diamantne plošče (Ø) (mm)	Višina segmenta (mm)	Debelina rezila (mm)	Največje število obratov (min <sup>-1</sup> )	Opis	Primerno za	Cena z DDV
P-22327	150	22,23	7	2,1	10.180	segmentni rob	abrazive	
A-84121	180	25,4	7	2,3	8.500	segmentni rob	beton	
D-41604	180	22,23	7	2,4	8.500	segmentni rob	beton	
D-52772	180	22,23	7	2,2	8.500	segmentni rob	beton, marmor	
A-84137	230	22,23	7	2,5	6.600	segmentni rob	beton	
D-41610	230	22,23	7	2,6	6.650	segmentni rob	beton	
D-52788	230	22,23	7	2,4	6.650	segmentni rob	beton, marmor	
E-02967	230	22,23	7	2,4	6.650	segmentni rob	beton	

Akumulat orji in polnilniki

Pribor za akumulat orsko orodje

Akumulat orske svetilke in pribor

Pribor za lasarske merilnike

Pribor za rušenje in vrtanje

Pribor za vrtanje

Kronske žage

Pribor za vijčenje

Pribor za rezanje in brušenje

Pribor za poliranje in brušenje

Pribor za rezkanje in oblanje

Pribor za multitfunkcijsko orodje

Pribor za žaganje

Pribor za žebjalnike in spenjalnike

Pribor za fene

Pribor za sesanje

Pribor orodja za uporabo na prostem

Pribor za čiščenje orodja in zaščitna oprema

Kovčki in torbe za orodje

Ročno orodje

Razno

Pribor za mešanje

# DIAMANTNE REZALNE PLOŠČE

## Idealne za akumulatorsko orodje



### ZA PLOŠČICE



#### 1. Idealne za akumulatorska orodja

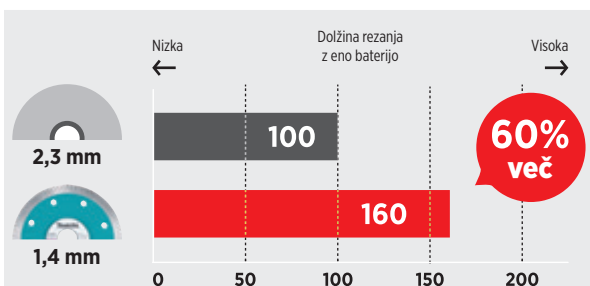

#### OPOMBA:

1. Rezultati testa so odvisni od različnih dejavnikov
2. Številke v grafu označujejo relativne vrednosti, v razmerju z Makitino diamantno rezalno ploščo (debeline 2,3 mm) nastavljeno na 100.

#### 2. Tanjša rezilo - gladko in enostavno rezanje.



### ZA GRANIT, BETON IN MARMOR

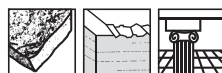

#### 1. Idealne za akumulatorska orodja

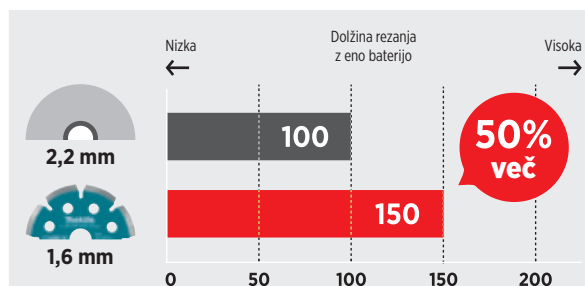

#### OPOMBA:

1. Rezultati testa so odvisni od različnih dejavnikov
2. Številke v grafu označujejo relativne vrednosti, v razmerju z Makitino diamantno rezalno ploščo (debeline 2,2 mm) nastavljeno na 100.

#### 2. Tanko rezilo in majhna teža





## Diamantne plošče za suho rezanje - valoviti rob



Koda	Diamantna plošča (Ø) (mm)	Luknja diamantne plošče (Ø) (mm)	Višina segmenta (mm)	Debelina rezila (mm)	Največje število obratov (min <sup>-1</sup> )	Opis	Primerno za	Cena z DDV
A-84193	105	20	7	2	15.300	valoviti rob	beton	
B-46327	115	22,23	10	1,4	13.300	valoviti rob	keramične ploščice	
D-41626	115	22,23	7	2,3	13.300	valoviti rob	beton	
D-52794	115	22,23	7	2,2	13.300	valoviti rob	beton, marmor	
A-80438	125	22,23	7,5	2	12.220	valoviti rob	beton	
B-46333	125	22,23	10	1,4	12.250	valoviti rob	keramične ploščice	
D-41632	125	22,23	7	2,5	12.250	valoviti rob	beton	
P-22311	150	22,23	7	2,4	10.180	valoviti rob	beton	
A-84078	180	25,4	7	2,3	8.700	valoviti rob	granit, beton	
D-41648	180	22,23	7	2,6	8.500	valoviti rob	beton	
A-84171	230	22,23	7	2,6	6.640	valoviti rob	beton	
D-41654	230	22,23	7	3,1	6.650	valoviti rob	beton	
D-52825	230	22,23	7	1,8	6.650	valoviti rob	beton, marmor	



## Diamantne plošče za mokro rezanje - valoviti rob



Koda	Diamantna plošča (Ø) (mm)	Luknja diamantne plošče (Ø) (mm)	Višina segmenta (mm)	Debelina rezila (mm)	Največje število obratov (min <sup>-1</sup> )	Opis	Primerno za	Za model	Cena z DDV
B-22034	110	20	5	2	13.880	valoviti rob	kamen	4101RH	

 Akumulat  
orji in  
pnilniki

 Pribor za  
akumulat  
orsko  
orodje

 Akumulat  
orske  
svetilke  
in pribor

 Pribor za  
lasarske  
merilnike

 Pribor za  
rušenje  
in vrtanje

 Pribor za  
vrtanje

 Kronske  
žage

 Pribor za  
vijačenje

 Pribor za  
rezanje  
in  
brušenje

 Pribor za  
poliranje  
in  
brušenje

 Pribor za  
rezkanje  
in  
oblanje

 Pribor za  
multifunk  
cijsko  
orodje

 Pribor za  
žaganje

 Pribor za  
žebjalnike  
in  
spenjalnike

 Pribor za  
fene

 Pribor za  
sesanje

 Pribor  
orodja za  
uporabo  
na prostem

 Pribor za  
protežno  
orodje in  
zaščitna  
oprema

 Kovčki in  
torbe za  
orodje

 Ročno  
orodje

Razno

 Pribor za  
mešanje





## Diamantne plošče za suho rezanje - gladki rob



Koda	Diamantna plošča (Ø) (mm)	Luknja diamantne plošče (Ø) (mm)	Debelina rezila (mm)	Največje število obratov (min <sup>-1</sup> )	Opis	Primerno za	Cena z DDV
D-52716	110	22,23	1,8	13.880	gladki rob	keramične ploščice	



## Diamantne plošče za mokro rezanje - gladki rob

Uporablja se za mokro rezanje. Rezalna plošča z gladkim robom. Za rezanje: keramičnih ploščic in stekla.

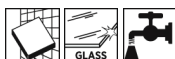

Koda	Diamantna plošča (Ø) (mm)	Luknja diamantne plošče (Ø) (mm)	Višina segmenta (mm)	Debelina rezila (mm)	Največje število obratov (min <sup>-1</sup> )	Opis	Primerno za	Za model	Cena z DDV
B-21098	85	15	5	1,8	4.500	gladki rob	ploščice, steklo	CC300DW, CC301D	



## Reducirni obroči

Koda	Notranji premer (mm)	Zunanji premer (mm)	Enota (kos/set)	Cena z DDV
A-85248	20	22,23	10/1	
A-86860	16	20	10/1	

Akumulatorji in polnilniki  
 Pribor za akumulatsko orodje  
 Akumulatorske svetilke in pribor  
 Pribor za lasarske merilnike  
 Pribor za rušenje in vrtanje  
 Pribor za vrtanje  
 Kronske žage  
 Pribor za vijačenje  
 Pribor za rezanje in brušenje  
 Pribor za poliranje in brušenje  
 Pribor za rezanje in oblanje  
 Pribor za multitank cijsko orodje  
 Pribor za žaganje  
 Pribor za žebjalnike in spenjalnike  
 Pribor za fene  
 Pribor za sesanje  
 Pribor za uporabo na prostem  
 Pribor za nosenje orodja in zasajna oprema  
 Kovčki in torbe za orodje  
 Ročno orodje  
 Razno  
 Pribor za mešanje



## X-LOCK diamantne plošče za suho rezanje - segmentne

Namestitev in odstranitev brez uporabe orodja. Sistem preprečuje prekomerno ali prenizko zategovanje plošč.



Koda	Diamantna plošča (Ø) (mm)	Vpetje	Debelina rezila (mm)	Višina segmenta (mm)	Največje število obratov (min <sup>-1</sup> )	Opis	Primerno za	Cena z DDV
E-02060	115	X-LOCK	2.2	7	13.300	segmentni rob	granit, beton, marmor	
E-02076	125	X-LOCK	2.2	7	12.250	segmentni rob	granit, beton, marmor	



## X-LOCK diamantne plošče z robom iz volframovega karbida

Namestitev in odstranitev brez uporabe orodja. Sistem preprečuje prekomerno ali prenizko zategovanje plošč.

Koda	Debelina rezila (mm)	Diamantna plošča (Ø) (mm)	Največje število obratov (min <sup>-1</sup> )	Vpetje	Primerno za	Za model	Cena z DDV
E-11776	2	125	12.250	X-LOCK	PVC, mavčne plošče, FRP plošče, materiali iz vlaken	X-LOCK kotni brusilniki	

Akumulat  
orji in  
poinliniki

Pribor za  
akumulat  
orsko  
orodje

Akumulat  
orske  
svetilke  
in pribor

Pribor za  
laserske  
merilnike

Pribor za  
rušenje  
in vrtanje

Pribor za  
vrtanje

Kronske  
žage

Pribor za  
vijačenje

Pribor za  
rezanje  
in  
brušenje

Pribor za  
poliranje  
in  
brušenje

Pribor za  
rezkanje  
in  
oblanje

Pribor za  
multifunk  
cjsko  
orodje

Pribor za  
žaganje

Pribor za  
žebjalnike  
in  
spenjalnike

Pribor za  
fene

Pribor za  
sesanje

Pribor  
orodja za  
uporabo  
na prostem

Pribor za  
pomoč je  
orodja in  
zaščitna  
oprema

Kovčki in  
torbe za  
orodje

Ročno  
orodje

Razno

Pribor za  
mešanje

## DIAMANTNE LONČASTE BRUSILNE PLOŠČE

ENOJNI ROB

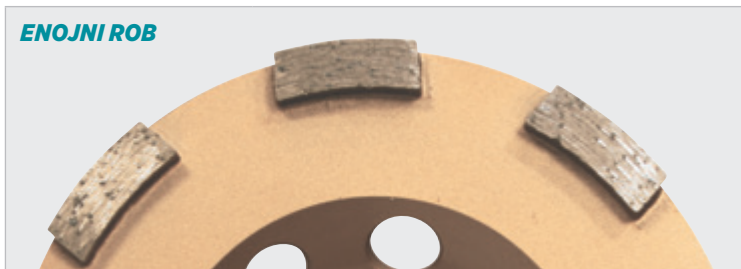

### Grobo delo

Hitrejše in bolj učinkovite od plošč za standardno delo. Namenjene za visoko stopnjo odstranjevanja oblog.

DVOJNI ROB

SEGMENTIRAN ROB

VENTILATORSKI TIP



### Standardno delo

Po značilnostih so te plošče nekje med ploščami za grobo delo in zaključna dela. Namenjene so za srednjo stopnjo odstranjevanja oblog in za doseganje čiste in gladke površine.

TURBO TIP

GLADEK ROB

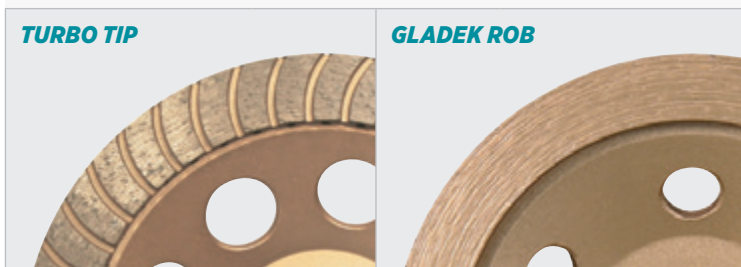

### Zaključna dela

Namenjene za fino brušenje površin, zaključna dela ter natančno oblikovanje kotov in robov.

## SPECIALIZED

PCD



### Odstranjevanje barve

Plošče so namenjene za odstranjevanje poliuretana, lepil, barv, epoksija in akrilnih premazov.

Zobje so izdelani iz polikristalnega diamanta (PCD) za izjemno odpornost, učinkovitost in lepši zaključek površin.

## Z DUŠENJEM VIBRACIJ

LOW VIBRATION



### Nizke vibracije

Dva gumijasta obroča blažita vibracije ter zmanjšata njihov prenos na uporabnika, kar močno zmanjša obremenitev pri delu.

### Večja stabilnost

Manj vibracij pomeni tudi boljši stik z obdelovalno površino za hitrejšo, bolj učinkovito in enakomerno brušenje.



standardno

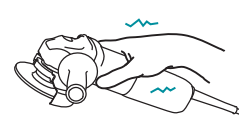

z dušenjem vibracij

## Brusilne in polirne plošče

### Diamantne lončaste brusilne plošče

Izberite lahko med segmentnimi diamantnimi lončastimi brusilnimi ploščami za grobo delo in z enakomernim robom za končno obdelavo. Diamantne lončaste brusilne plošče so za čiščenje in brušenje betonskih površin, primerne tudi za brušenje naravnega kamna.



Koda	Naziv	Premer (Ø) (mm)	Premer luknje (Ø) (mm)	Širina segmenta (mm)	Višina segmenta (mm)	Primereno za	Za model	Največje število obratov (min <sup>-1</sup> )	Cena z DDV	
A-07369	Diamantna lončasta brusilna plošča, valovita	110	15	13,5	4	splošno uporabo	PC1100	13.900		
D-60676	Diamantna lončasta brusilna plošča (enojni rob)	115	22,23	8	5	grobo obdelavo	115 mm kotni brusilniki	13.300		
D-62315	Diamantna lončasta brusilna plošča (dvojni rob)	115	22,23	8	5	splošno uporabo	115 mm kotni brusilniki	13.300		
D-62343	Diamantna lončasta brusilna plošča (turbo rob)	115	22,23	8	5	zaključna dela	115 mm kotni brusilniki	13.300		
B-12289	Diamantna lončasta brusilna plošča	125	22,23	14,2	4,2	zaključna dela	PC5000, PC5001C, 125 mm kotni brusilniki	12.200		
B-12295	Diamantna lončasta brusilna plošča	125	22,23	8	5	grobo obdelavo	PC5000, PC5001C, 125 mm kotni brusilniki	12.200		
B-38560	Diamantna lončasta brusilna plošča	125	M14	/	/	splošno uporabo	125 mm kotni brusilniki	12.200		 
B-48533	Diamantna lončasta brusilna plošča	125	M14	8	5,5	grobo obdelavo	125 mm kotni brusilniki	12.200		 
B-48549	Diamantna lončasta brusilna plošča	125	M14	8	5,5	grobo obdelavo	125 mm kotni brusilniki	12.200		 
B-48555	Diamantna lončasta brusilna plošča	125	M14	7	5,5	splošno uporabo	125 mm kotni brusilniki	12.200		 
B-48577	Diamantna lončasta brusilna plošča	125	22,23	8	5,5	grobo obdelavo	PC5000, PC5001C, 125 mm kotni brusilniki	12.200		

Nadaljevanje...

Akumulat  
orji in  
polnilniki

Pribor za  
akumulat  
orsko  
orodje

Akumulat  
orske  
svetilke  
in pribor

Pribor za  
lasarske  
merilnike

Pribor za  
rušenje  
in vrtanje

Pribor za  
vrtanje

Kronske  
žage

Pribor za  
vijačenje

Pribor za  
rezanje  
in  
brušenje

Pribor za  
poliranje  
in  
brušenje

Pribor za  
rezkanje  
in  
oblanje

Pribor za  
multifunk  
cjsko  
orodje

Pribor za  
žaganje

Pribor za  
žebjalnike  
in  
spenjalnike

Pribor za  
fene

Pribor za  
sesanje

Pribor  
orodja za  
uporabo  
na prostem

Pribor za  
ploščne  
orodja in  
zaščitna  
oprema

Kovčki in  
torbe za  
orodje

Ročno  
orodje

Razno

Pribor za  
mešanje



# Pribor za rezanje in brušenje

	Koda	Naziv	Premer (Ø) (mm)	Premer luknje (Ø) (mm)	Širina segmenta (mm)	Višina segmenta (mm)	Primereno za	Za model	Največje število obratov (min <sup>-1</sup> )	Cena z DDV
Akumulat orji in polnilniki										
Pribor za akumulat orsko orodje	B-48583	Diamantna lončasta brusilna plošča	125	22,23	7	5,5	splošno uporabo	PC5000, PC5001C, 125 mm kotni brusilniki	12.200	
Akumulat orske svetilke in pribor	B-53160	PCD diamantna lončasta brusilna plošča	125	22,23	/	/	odstranjevanje poliuretana, lepil, barve, epoxy in akrilnih premazov	PC5000, PC5001C, 125 mm kotni brusilniki	12.200	
Pribor za laserske merilnike	D-41458	Diamantna lončasta brusilna plošča	125	22,23	7,5	5,3	grobno obdelavo	PC5000, PC5001C	12.250	
Pribor za rušenje in vrtanje	D-41464	Diamantna lončasta brusilna plošča	125	22,23	13	4,2	zaključna dela	PC5000, PC5001C	12.250	
Pribor za vrtanje	D-60682	Diamantna lončasta brusilna plošča (enojni rob)	125	22,23	8	5	grobno obdelavo	PC5000, PC5001C, 125 mm kotni brusilniki	12.250	
Kronske žage	D-66715	Diamantna lončasta brusilna plošča (dvojni rob)	125	22,23	7	5,5	splošno uporabo	125 mm kotni brusilniki	12.250	
Pribor za vijačenje	D-66721	Diamantna lončasta brusilna plošča (turbo rob)	125	22,23	13	4,2	zaključna dela	125 mm kotni brusilniki	12.250	
Pribor za rezanje in brušenje	B-48608	Diamantna lončasta brusilna plošča	180	M14	8	5	grobno obdelavo	180 mm kotni brusilniki	8.500	
Pribor za poliranje in brušenje	B-48614	Diamantna lončasta brusilna plošča	180	M14	7	5	splošno uporabo	180 mm kotni brusilniki	8.500	
Pribor za rezkanje in oblanje	B-48620	Diamantna lončasta brusilna plošča	180	M14	20	5	zaključna dela	180 mm kotni brusilniki	8.500	
Pribor za multitfunkcijsko orodje	B-48642	Diamantna lončasta brusilna plošča	180	22,23	8	5	grobno obdelavo	180 mm kotni brusilniki	8.500	
Pribor za žaganje	B-48658	Diamantna lončasta brusilna plošča	180	22,23	7	5	splošno uporabo	180 mm kotni brusilniki	8.500	
Pribor za žebljanje in spenjanje	B-48664	Diamantna lončasta brusilna plošča	180	22,23	20	5	zaključna dela	180 mm kotni brusilniki	8.500	
Pribor za fene										
Pribor za sesanje										
Pribor za uporabo na prostem										
Pribor za nosenje orodja in zaščitna oprema										
Kovčki in torbe za orodje										
Ročno orodje										
Razno										
Pribor za mešanje										





[Nadaljevanje...](#)



# Pribor za rezanje in brušenje

Koda	Naziv	Premer (Ø) (mm)	Premer luknje (Ø) (mm)	Širina segmenta (mm)	Višina segmenta (mm)	Primerno za	Za model	Največje število obratov (min <sup>-1</sup> )	Cena z DDV	
D-62290	Diamantna lončasta brusilna plošča (enojni rob)	180	22,23	8	5	grobo obdelavo	180 mm kotni brusilniki	8.500		
D-62321	Diamantna lončasta brusilna plošča (dvojni rob)	180	22,23	8	5	splošno uporabo	180 mm kotni brusilniki	8.500		
D-62359	Diamantna lončasta brusilna plošča (turbo rob)	180	22,23	8	5	zaključna dela	180 mm kotni brusilniki	8.500		

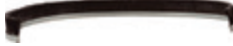
## Protiprašni obroči in ščetke

Koda	Naziv	Za model	Cena z DDV	
424525-4	Zaščitni protiprašni obroč A	PC5000C, PC5001C		
424526-2	Protiprašna zaščita B	PC5000C, PC5001C		
743340-0	Zaščitna ščetka za protiprašni obroč A	PC5000C, PC5001C		
743341-8	Zaščitna ščetka za protiprašno zaščito B	PC5000C, PC5001C		



743080-0



## Diamantne polirne plošče



Koda	Naziv	Premer (Ø) (mm)	Zrnatost	Za model	Enota (kos/set)	Cena z DDV
154662-7	Zaščitni protiprašni pokrov	/	/	PW5000CH	1	
443121-9	Ščetka za ščitnik za prah	/	/	PW5000CH	1	
743080-0	Podloga za polirno ploščo	100	/	PW5000CH	1	
D-15584	Diamantna polirna plošča, modra	100	50	PW5000CH	1	
D-15590	Diamantna polirna plošča, rumena	100	100	PW5000CH	1	
D-15609	Diamantna polirna plošča, oranžna	100	200	PW5000CH	1	
D-15615	Diamantna polirna plošča, rdeča	100	400	PW5000CH	1	
D-15621	Diamantna polirna plošča, temno zelena	100	800	PW5000CH	1	
D-15637	Diamantna polirna plošča, svetlo zelena	100	1.500	PW5000CH	1	

[Nadaljevanje...](#)

Akumulat orji in polnilniki  
 Pribor za akumulat orsko orodje  
 Akumulat orske svetilke in pribor  
 Pribor za laserske merilnike  
 Pribor za rušenje in vrtanje  
 Pribor za vrtanje  
 Kronske žage  
 Pribor za vijačenje  
 Pribor za rezanje in brušenje  
 Pribor za poliranje in brušenje  
 Pribor za rezkanje in oblanje  
 Pribor za multitank ciklo orodje  
 Pribor za žaganje  
 Pribor za žebjalnike in spenjalnike  
 Pribor za fene  
 Pribor za sesanje  
 Pribor orodja za uporabo na prostem  
 Pribor za ploščo in orodja za zaščito optima  
 Kovčki in torbe za orodje  
 Ročno orodje  
 Razno  
 Pribor za mešanje

# Pribor za rezanje in brušenje

Koda	Naziv	Premer (Ø) (mm)	Zrnatost	Za model	Enota (kos/set)	Cena z DDV
D-15643	Diamantna polirna plošča, rjava	100	3.000	PW5000CH	1	
D-15659	Diamantna polirna plošča, zelena	100	/	PW5000CH	1	
D-15805	8-delni set diamantnih polirnih plošč	100	50-3.000	PW5000CH	8/1	

## Polirne plošče



	Koda	Naziv	Premer (Ø) (mm)	Zrnatost	Za model	Cena z DDV
	P-50077	Nastavek za polirno ploščo, M14	100	/	PW5000CH	
	P-50108	Polirna plošča za beton, mokro poliranje	100	400	PW5000CH	
	P-50114	Polirna plošča za beton, mokro poliranje	100	600	PW5000CH	
	P-52152	Polirna plošča za beton, suho poliranje	100	220	PW5000CH	
	P-52168	Polirna plošča za beton, suho poliranje	100	320	PW5000CH	

## Vakumsko spajkane diamantne vrtalne krome za kotne brusilnike

### Vakumsko spajkane diamantne vrtalne krome za kotne brusilnike

Za kotne brusilnike z M14 navojem. Vrtalna krona z diamantno konico ima obrobo iz visokokakovostnih diamantov, ki so vakuumsko spajkani na njen obod. Ta postopek spajanja materialov ustvari vez, ki je veliko močnejša kot pri drugih metodah.



Koda	Premer (Ø) (mm)	Vpetje (mm)	Največje število obratov (min <sup>-1</sup> )	Cena z DDV
D-61064	5	M14	12.000	
D-61070	6	M14	12.000	
D-61086	8	M14	12.000	
D-61092	10	M14	12.000	
D-61101	12	M14	12.000	
D-44432	14	M14	12.000	
D-44448	16	M14	12.000	
D-44454	20	M14	12.000	
D-44460	22	M14	12.000	
D-44476	25	M14	12.000	
D-44482	27	M14	12.000	
D-44498	30	M14	12.000	
D-44507	32	M14	12.000	
D-44513	35	M14	12.000	
D-44529	38	M14	12.000	
D-44535	40	M14	12.000	
D-44541	45	M14	12.000	
D-44557	51	M14	12.000	
D-44563	55	M14	12.000	
D-44579	57	M14	12.000	
D-44585	60	M14	12.000	
D-44591	65	M14	12.000	
D-44600	67	M14	12.000	
D-44616	68	M14	12.000	
D-44622	70	M14	12.000	
D-44638	75	M14	12.000	
D-44644	80	M14	12.000	
D-44650	83	M14	12.000	

Akumulat  
orji in  
poinliniki

Pribor za  
akumulat  
orsko  
oročje

Akumulat  
orske  
svetilke  
in pribor

Pribor za  
lasarske  
merilnike

Pribor za  
rušenje  
in vrtanje

Pribor za  
vrtanje

Kronske  
žage

Pribor za  
vijačenje

Pribor za  
rezanje  
in  
brušenje

Pribor za  
poliranje  
in  
brušenje

Pribor za  
rezkanje  
in  
oblanje

Pribor za  
multifunk  
cijsko  
oročje

Pribor za  
žaganje

Pribor za  
žebjalnike  
in  
spenjalnike

Pribor za  
fene

Pribor za  
sesanje

Pribor  
oročja za  
uporabo  
na prostem

Pribor za  
prosto  
oročje in  
zaščitna  
oprema

Kovčki in  
torbe za  
oročje

Ročno  
oročje

Razno

Pribor za  
mešanje



# REZALNE IN BRUSILNE PLOŠČE

## TANKE REZALNE PLOŠČE za akumulatorske kotne brusilnike



### PREDNOSTI AKUMULATORSKE SERIJE

Visoka učinkovitost skrajša delovni čas.  
Več dela z enim polnjenjem akumulatorja.

### MATERIALI



### KOLIČINA DELA

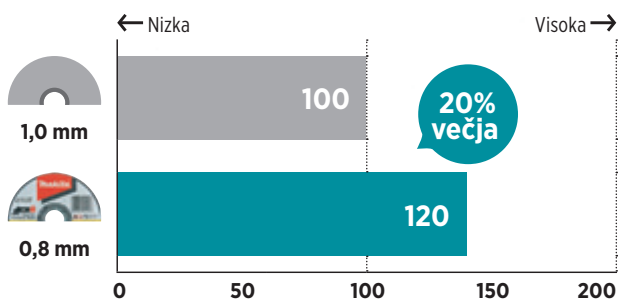

OPOMBA: 1. Rezultati preizkusa so odvisni od različnih dejavnikov. 2. Vrednosti v diagramih so relativne vrednosti, kjer ima zmogljivost rezanja z Makita ploščo (debelina: 1,0 mm) indeks 100.

### PRIMERJAVA



## BRUSILNE PLOŠČE za industrijsko uporabo



### ZNAČILNOSTI

Dolga življenjska doba.  
Visoka zmogljivost za industrijsko uporabo.

### MATERIALI



### ŽIVLJENJSKA DOBA

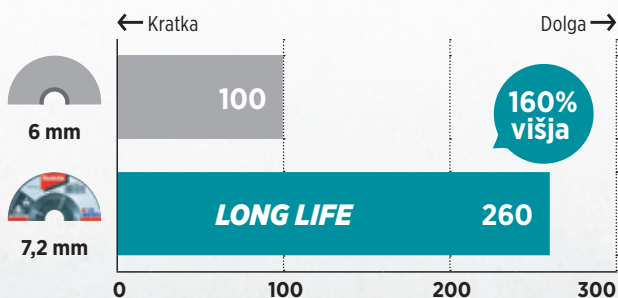

### DEBELINA PLOŠČE

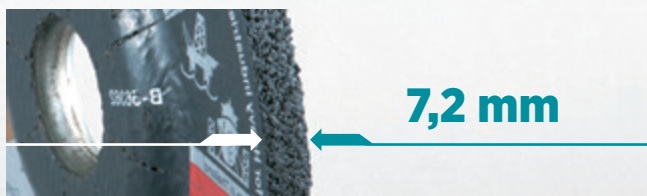



## Rezalne plošče



## Rezalne plošče za nerjavno jeklo

Tanka in visoko zmogljiva rezalna plošča s srednjo trdoto, nizka obremenitev naprave, majhna obraba in visoka stopnja varčevanja z energijo, izjemno visoka rezalna zmogljivost in dolga življenjska doba.



Koda	Tip plošče	Rezalna plošča (Ø) (mm)	Luknja rezalne plošče (Ø) (mm)	Debelina plošče (mm)	Največje število obratov (min <sup>-1</sup> )	Opis	Cena z DDV
B-45755	A36S	115	22,23	1,6	13.300	ravna	
B-46947	Z60T	115	22,23	0,8	13.300	vbočena	
D-18764	WA60T	115	22,23	1,2	13.290	ravna	
E-03034	A60U	115	22,23	1,0	13.300	ravna	
E-10861	Z60U	115	22,23	0,8	12.250	ravna	
B-46931	A36S	125	22,23	1,6	12.250	ravna	
D-18770	WA60T	125	22,23	1,2	12.200	ravna	
E-03040	A60U	125	22,23	1,0	12.250	ravna	
E-10877	Z60U	125	22,23	0,8	12.250	ravna	
B-12251	A60T	150	22,23	1,6	10.200	ravna	
B-12267	A60T	180	22,23	1,6	8.500	ravna	
B-60458	A36S	180	22,23	1,8	8.500	ravna	
D-18786	WA36R	180	22,23	2,0	8.600	ravna	
B-12273	A60T	230	22,23	1,9	6.650	ravna	
B-60464	A36S	230	22,23	2,0	6.600	ravna	
D-18792	WA36R	230	22,23	2,0	6.600	ravna	
D-18845	WA36R	230	22,23	2,0	6.600	vbočena	
E-03006	WA36R	230	22,23	2,0	6.650	ravna	
E-13764	A60U	230	22,23	1,9	6.650	ravna	



## Komplet rezalnih plošč za nerjavno jeklo v embalaži



Koda	Tip plošče	Rezalna plošča (Ø) (mm)	Luknja rezalne plošče (Ø) (mm)	Debelina plošče (mm)	Največje število obratov (min <sup>-1</sup> )	Opis	Enota (kos/set)	Cena z DDV
D-18764-10	WA60T	115	22,23	1,2	13.290	ravna	10/1	
E-03034-12	A60U	115	22,23	1,0	13.300	ravna	12/1	

Nadaljevanje...

# Pribor za rezanje in brušenje

153

Koda	Tip plošče	Rezalna plošča (Ø) (mm)	Luknja rezalne plošče (Ø) (mm)	Debelina plošče (mm)	Največje število obratov (min <sup>-1</sup> )	Opis	Enota (kos/set)	Cena z DDV
B-45733-12	Z60T	125	22,23	0,8	12.250	ravna	12/1	
D-18770-10	WA60T	125	22,23	1,2	12.200	ravna	10/1	
D-18770-100	WA60T	125	22,23	1,2	12.200	ravna	100/1	
E-03040-12	A60U	125	22,23	1,0	12.250	ravna	12/1	



## Rezalne plošče za kovino

Hladno stisnjena in s smolo vezana rezalna plošča, visoka rezalna zmogljivost in dolga življenjska doba.



Koda	Tip plošče	Rezalna plošča (Ø) (mm)	Luknja rezalne plošče (Ø) (mm)	Debelina plošče (mm)	Največje število obratov (min <sup>-1</sup> )	Opis	Enota (kos/set)	Diamantna plošča (Ø) (mm)	Cena z DDV
D-18568	A30S	115	22,23	3	13.290	vbočena	1		
D-18661	A30S	115	22,23	2,5	13.290	ravna	1		
A-85313	A30R	125	22,23	2,5	12.230	ravna	1		
D-18574	A30S	125	22,23	3	12.200	vbočena	1		
D-18677	A30S	125	22,23	2,5	12.200	ravna	1		
D-18683	A30S	180	22,23	2,5	8.600	ravna	1		
A-85335	A30R	230	22,23	2,5	6.650	ravna	1		
D-18596	A30S	230	22,23	3	6.600	vbočena	1		
D-18699	A30S	230	22,23	2,5	6.600	ravna	1		
B-10665-5	A36P	355	25,4	3	4.400	ravna	5/1		
B-49448-5	A36P-BF	355	25,4	2,5	4.400	ravna	5/1		
B-64353-5	A30P	355	25,4	3	4.400	ravna	5/1		
B-64696-5	A36P	355	25,4	2,5	4.400	ravna	5/1		
E-12790-5	A24T	355	25,4	4	5.500	ravna	5/1	355	

Akumulat orj in polnilniki  
 Pribor za akumulat orsko orodje  
 Akumulat orske svetilke in pribor  
 Pribor za laserske merilnike  
 Pribor za rušenje in vrtnanje  
 Pribor za vrtnanje  
 Kronske žage  
 Pribor za vijačenje  
 Pribor za rezanje in brušenje  
 Pribor za poliranje in brušenje  
 Pribor za rezkanje in oblanje  
 Pribor za multitank cliko orodje  
 Pribor za žebjalnike in spenjalnike  
 Pribor za fene  
 Pribor za sesanje  
 Pribor orodja za uporabo na prostem  
 Pribor za ploščje orodja in zaščitna oprema  
 Kovčki in torbe za orodje  
 Ročno orodje  
 Razno  
 Pribor za mešanje



## Rezalne plošče za aluminij



Koda	Tip plošče	Rezalna ploščica (Ø) (mm)	Luknja rezalne ploščice (Ø) (mm)	Debelina ploščice (mm)	Največje število obratov (min <sup>-1</sup> )	Opis	Cena z DDV
B-45331	A60T	125	22,23	1	12.250	ravna	



## X-LOCK rezalne plošče za nerjavno jeklo

Namestitiv in odstranitev brez uporabe orodja. Sistem preprečuje prekomerno ali prenizko zategovanje plošč. Primerne so za vse X-LOCK kotne brusilnike in vse kotne brusilnike z namestitveno matico.



Koda	Tip plošče	Rezalna ploščica (Ø) (mm)	Vpetje	Debelina ploščice (mm)	Največje število obratov (min <sup>-1</sup> )	Opis	Cena z DDV
E-00387	A60T	115	X-LOCK	1,2	13.300	ravna	
E-00418	A60T	125	X-LOCK	1,2	12.250	ravna	



## Večnamenske rezalne plošče

Koda	Naziv	Debelina ploščice (mm)	Rezalna ploščica (Ø) (mm)	Luknja rezalne ploščice (Ø) (mm)	Tip ploščice	Največje število obratov (min <sup>-1</sup> )	Opis	Cena z DDV
E-10724	Tanka rezalna ploščica večnamenska	1,2	125	22,23	C46T	12.250	ravna	

Akumulator  
orj in  
poinlinikiPribor za  
akumulat  
orsko  
orodjeAkumulator  
orske  
svetilke  
in priborPribor za  
lasarske  
merilnikePribor za  
rušenje  
in vrtanjePribor za  
vrtanjeKronске  
žagePribor za  
vijačenjePribor za  
rezanje  
in  
brušenjePribor za  
poliranje  
in  
brušenjePribor za  
rezanje  
oblanjePribor za  
multitank  
cjsko  
orodjePribor za  
žaganjePribor za  
žebjalnike  
in  
spenjalnikePribor za  
fenePribor za  
sesanjePribor  
orodja za  
uporabo  
na prostemPribor za  
nosenje  
orodja in  
zaščitna  
opremaKovčki in  
torbe za  
orodjeRočno  
orodje

Razno

Pribor za  
mešanje

## Brusilne plošče



### Brusilne plošče za nerjavno jeklo



Koda	Tip plošče	Brusilna plošča (Ø) (mm)	Luknja brusilne plošče (Ø) (mm)	Debelina plošče (mm)	Največje število obratov (min <sup>-1</sup> )	Cena z DDV
A-80640	WA36N	115	22,23	6	13.290	
A-80656	WA36N	125	22,23	6	12.200	



### Brusilne plošče za kovino

Makita brusilne plošče za kovino so univerzalne brusilne plošče srednje trdote, ki so primerne za vse vrste in načine obdelave kovin. Brusilni diski imajo groba zrna, ki se uporabljajo za brušenje večjih globin. Površina po brušenju je zato tudi bolj groba. Uporaba: čiščenje zvarov, čiščenje ulitkov, brušenje robov in ravnih površin, obdelava kotnih zvarov, obdelava zloženih zvarov, razigljenje. Hladno stisnjene in s smolo vezane univerzalne brusilne plošče srednje trdote so primerne za vse vrste obdelave kovin, npr.: brušenje in posnemanje robov in ravnih površin. Posebna prednost je velika globina brušenja in dolga življenjska doba.



Koda	Tip plošče	Brusilna plošča (Ø) (mm)	Luknja brusilne plošče (Ø) (mm)	Debelina plošče (mm)	Največje število obratov (min <sup>-1</sup> )	Enota (kos/set)	Cena z DDV
A-80927	A36P	115	22,23	6	13.300	1	
D-18459	A24R	115	22,23	6	13.290	1	
D-18459-20	A24R	115	22,23	6	13.290	20/1	
D-74485	A24P	115	22,23	6	13.300	1	
A-80933	A36P	125	22,23	6	12.230	1	
D-18465	A24R	125	22,23	6	12.200	1	
D-18465-20	A24R	125	22,23	6	12.200	20/1	
D-74491	A24P	125	22,23	6	12.250	1	
D-18471	A24R	180	22,23	6	8.600	1	
A-80955	A36P	230	22,23	6	6.500	1	
D-18487	A24R	230	22,23	6	6.600	1	
D-74522	A24P	230	22,23	6	6.650	1	

- Akumulat orji in polnilniki
- Pribor za akumulat orsko orodje
- Akumulat orske svetilke in pribor
- Pribor za laserske merilnike
- Pribor za rušenje in vrtanje
- Pribor za vrtanje
- Kronске žage
- Pribor za vijačenje
- Pribor za rezanje in brušenje
- Pribor za poliranje in brušenje
- Pribor za rezkanje in oblanje
- Pribor za multitank ciskno orodje
- Pribor za žaganje
- Pribor za žebjalnike in spenjalnike
- Pribor za fene
- Pribor za sesanje
- Pribor za uporabo na prostem
- Pribor za čiščenje orodja in zaščitna oprema
- Kovčki in torbe za orodje
- Ročno orodje
- Razno
- Pribor za mešanje

# Pribor za rezanje in brušenje



## Specialne čistilne brusilne plošče



Posebne brusilne plošče za odstranjevanje različnih materialov. Zrna brusilne plošče so izdelana iz SiC - silicijevega karbida in so povezana z lepilom, kar omogoča hitro opravljanje dela in manjšo porabo moči. Vlakna v brusilni plošči ustvarjajo blažilni učinek, kar preprečuje prekomerno brušenje ali poškodbe obdelovanca. Gladka površina po brušenju. Uporaba: odstranjevanje barve, rje in brušenje zvarov po varjenju. Barva: črna - standardna, vijolična - podaljšana življenjska doba.



Koda	Brusilna plošča (Ø) (mm)	Luknja brusilne plošče (Ø) (mm)	Podloga	Vlakna	Največje število obratov (min <sup>-1</sup> )	Cena z DDV
B-28977	115	22,23	steklena vlakna	črna	12.000	
B-29016	115	22,23	steklena vlakna	vijolična	12.000	
B-29050	115	22,23	najlonska vlakna	črna	12.000	
B-36251	115	22,23	najlonska vlakna	vijolična	12.000	
B-28983	125	22,23	steklena vlakna	črna	12.000	
B-29022	125	22,23	steklena vlakna	vijolična	12.000	
B-29066	125	22,23	najlonska vlakna	črna	12.000	
B-36267	125	22,23	najlonska vlakna	vijolična	12.000	
B-28999	180	22,23	steklena vlakna	črna	8.500	
B-29038	180	22,23	steklena vlakna	vijolična	8.500	
B-36239	180	22,23	najlonska vlakna	črna	5.800	

Barva	Tip	Hitrost	Življenjska doba
	Standardni	100%	100%
	Podaljšana življ. doba	94%	130%



## X-LOCK Brusilne plošče za nerjavno jeklo

Namestitiv in odstranitiv brez uporabe orodja. Sistem preprečuje prekomerno ali prenizko zategovanje plošč. Primerne so za vse X-LOCK kotne brusilnike in vse kotne brusilnike z namestitveno matico.



Koda	Rezalna plošča (Ø) (mm)	Debelina plošče (mm)	Vpetje	Tip plošče	Največje število obratov (min <sup>-1</sup> )	Opis	Cena z DDV
E-00371	115	6	X-LOCK	WA36N	13.300	vbočena	
E-00402	125	6	X-LOCK	WA36N	12.250	vbočena	





## UPOGLJIVE BRUSILNE PLOŠČE

UPOGLJIVA STRUKTURA OMOGOČA BRUŠENJE VEČJIH POVRŠIN



VIBRATION  
60%  
DOWN  
Low  
VIBRATION

Idealne za  
aku. orodje



Low  
VIBRATION

**BRUŠENJE**

**POLIRANJE**

**ODSTRANJEVANJE ROBOV**

### NAVODILA ZA NAMESTITEV IN UPORABO BRUSILNE PLOŠČE

\*Obvezna uporaba podporne podloge

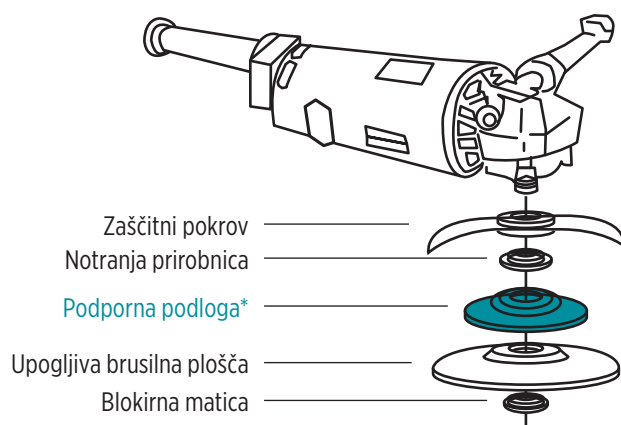

Naklon mora biti med 15 - 30°

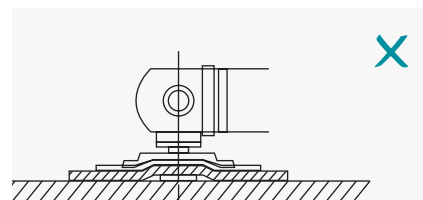
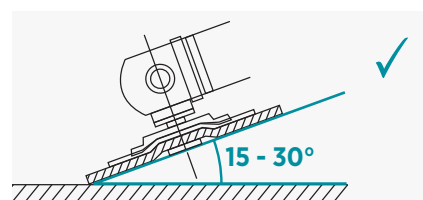

## Upogljive brusilne plošče



## Upogljive brusilne plošče za nerjavno jeklo za akumulatorske kotne brusilnike

Uporaba podpore podloge ni potrebna. Nižje vibracije in manjša utrujenost rok zaradi mikro prask na spodnjem delu plošče. Več brušenja z enim polnjenjem akumulatorja.



Koda	Brusilna plošča (Ø) (mm)	Luknja brusilne plošče (Ø) (mm)	Debelina plošče (mm)	Tip plošče	Največje število obratov (min <sup>-1</sup> )	Cena z DDV
B-53110	125	22,23	4	WA36P	12.250	

## Upogljive brusilne plošče za kovino



Obvezna uporaba podpore podloge. Manj hrupa. Nižje vibracije. Izjemno uporabne brusilne plošče, saj se zaradi upogljive strukture zelo malo odbijajo od obdelovalne površine in omogočajo brušenje večjih površin. Različni načini uporabe. Uporabljajte samo z ustrezno podporno podlogo za upogljive brusilne plošče.



Koda	Brusilna plošča (Ø) (mm)	Luknja brusilne plošče (Ø) (mm)	Debelina plošče (mm)	Tip plošče	Največje število obratov (min <sup>-1</sup> )	Cena z DDV
B-18275	115	22,23	3	AC36	13.300	
B-18281	115	22,23	3	AC46	13.300	
B-18297	115	22,23	3	AC60	13.300	
B-18306	115	22,23	3	AC80	13.300	

Akumulatorji in polnilniki  
 Pribor za akumulatorsko orodje  
 Akumulatorske svetilke in pribor  
 Pribor za laserske merilnike  
 Pribor za rušenje in vrtanje  
 Pribor za vrtanje  
 Kronske žage  
 Pribor za vijačenje  
 Pribor za rezanje in brušenje  
 Pribor za poliranje in brušenje  
 Pribor za rezkanje in oblanje  
 Pribor za multitank cijsko orodje  
 Pribor za žabljanke in spenjalnike  
 Pribor za fene  
 Pribor za sesanje  
 Pribor za uporabo na prostem  
 Pribor za nosenje orodja in zaščitna oprema  
 Kovčki in torbe za orodje  
 Ročno orodje  
 Razno  
 Pribor za mešanje

# LAMELNE BRUSILNE PLOŠČE



## LAMELNE BRUSILNE PLOŠČE ZA INDUSTRIJSKO UPORABO



Visoka učinkovitost  
Daljša življenjska doba

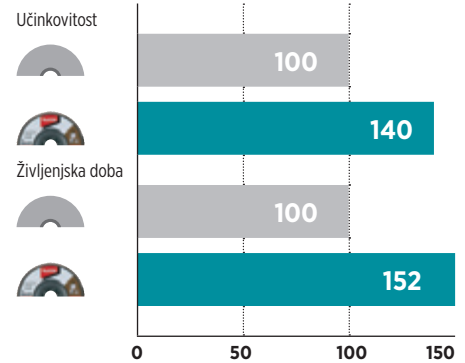

### PODLOGA



**Steklena vlakna**  
Univerzalna uporaba



**Najlonska vlakna**  
Industrijska uporaba

### OBLIKA



**Ravna**  
Primerna za ravne površine



**Kotna**  
Primerna za kote ali vogale

### POMEN OZNAK

Opis	A Rjavi korund (Taljen aluminij)	Z Cirkonijev korund (Taljeni aluminijev oksid)	C Karbo korund (Silicijev karbid)	Ce Oksidna keramika (Aluminijev oksid)
Barvna oznaka	Modra: kovine	Zlata: nerjavno jeklo in kovina	Zelena: beton	Srebrna: nerjavno jeklo, kovine, barvne kovine
WOOD	★			
PVC	★			
METAL	★★	★★		★★
Cu Ni Zn	★	★		★★
STAINLESS INOX NERJAVNO		★		★★
Beton			★★	

★★: Priporočljivo ★: Ustrezno



## Lamelne brusilne plošče



## Lamelne brusilne plošče za industrijsko uporabo

Lamelne brusilne plošče industrijskega razreda za kotne brusilnike.



Koda	Brusilna plošča (Ø) (mm)	Luknja brusilne plošče (Ø) (mm)	Zrnatost	Opis	Največje število obratov (min <sup>-1</sup> )	Cena z DDV
B-55603	115	22,23	Z40	kotna	13.300	
B-55619	115	22,23	Z60	kotna	13.300	
B-55625	115	22,23	Z80	kotna	13.300	
B-55631	115	22,23	Z120	kotna	13.300	
B-53920	125	22,23	Z40	kotna	12.200	
B-53936	125	22,23	Z60	kotna	12.200	
B-53942	125	22,23	Z80	kotna	12.200	
B-53958	125	22,23	Z120	kotna	12.200	
B-55647	180	22,23	Z40	kotna	8.600	
B-55653	180	22,23	Z60	kotna	8.500	
B-55669	180	22,23	Z80	kotna	8.500	
B-55675	180	22,23	Z120	kotna	8.500	

## Lamelne brusilne plošče za nerjavno jeklo - cirkonij

Odlični za brušenje nerjavnega jekla in kovine. Najpopularnejša vrsta lamelnih brusilnih plošč. Brušenje je enako učinkovito kot rezanje. Za odstranjevanje debelih slojev pod visokim pritiskom ali temperaturo. Lamelne brusilne plošče za nerjavno jeklo (cirkonij) so posebej primerne za zahtevnejša dela pri večjih obremenitvah – za grobo brušenje in tudi za končno obdelavo ter poliranje trdega jekla. Brusilni lističi se pahljačasto prekrivajo in so nameščeni na kvalitetno ploščo iz steklenih vlaken. Najpomembnejše lastnosti lamelnih brusilnih plošč so: visoka in konstantna stopnja brušenja pri nizki temperaturi, visoka kakovost obdelane površine, dolga življenjska doba, nizka raven hrupa. Uporaba: odstranjevanje rje, čiščenje odlikov, posnemanje robov, brušenje po robovih, odstranjevanje rje/kita, končna obdelava.



Koda	Brusilna plošča (Ø) (mm)	Luknja brusilne plošče (Ø) (mm)	Zrnatost	Največje število obratov (min <sup>-1</sup> )	Cena z DDV
D-63747	115	22,23	Z40	13.300	
D-63753	115	22,23	Z60	13.300	
D-63769	115	22,23	Z80	13.300	
D-63775	115	22,23	Z120	13.300	
P-65458	115	22,23	Z40	13.300	
P-65464	115	22,23	Z60	13.300	
P-65470	115	22,23	Z80	13.300	
P-65486	115	22,23	Z120	13.300	
B-22660	125	22,23	Z40	12.200	
B-22682	125	22,23	Z80	12.200	
B-22791	125	22,23	Z60	12.200	
B-22800	125	22,23	Z80	12.200	
B-22816	125	22,23	Z120	12.200	
D-63781	125	22,23	Z40	12.200	
D-63797	125	22,23	Z60	12.250	

Nadaljevanje...

# Pribor za rezanje in brušenje

Koda	Brusilna plošča (Ø) (mm)	Luknja brusilne plošče (Ø) (mm)	Zrnatost	Največje število obratov (min <sup>-1</sup> )	Cena z DDV
D-63806	125	22,23	Z80	12.250	
D-63812	125	22,23	Z120	12.250	
P-65492	125	22,23	Z40	12.250	
P-65501	125	22,23	Z60	12.000	
P-65517	125	22,23	Z80	12.000	
P-65523	125	22,23	Z120	12.000	
P-65539	150	22,23	Z40	10.200	
P-65545	150	22,23	Z60	10.200	
P-65551	150	22,23	Z80	10.200	
P-65567	150	22,23	Z120	10.200	
B-22707	180	22,23	Z40	8.500	
B-22713	180	22,23	Z60	8.500	
B-22729	180	22,23	Z80	8.500	
B-22735	180	22,23	Z120	8.500	
B-22822	180	22,23	Z40	8.500	
B-22838	180	22,23	Z60	8.500	
B-22844	180	22,23	Z80	8.500	
B-22850	180	22,23	Z120	8.500	
D-63828	180	22,23	Z40	8.500	
D-63834	180	22,23	Z60	8.500	
D-63840	180	22,23	Z80	8.500	
D-63856	180	22,23	Z120	8.500	
P-65573	180	22,23	Z40	8.600	
P-65589	180	22,23	Z60	8.600	
P-65595	180	22,23	Z80	8.600	
P-65604	180	22,23	Z120	8.600	

## Lamelne brusilne plošče za kovino - aluminijev oksid

Primeren za različne materiale: železne, neželezne, plastiko, les, itd. Lamelne brusilne plošče za kovino (aluminijev oksid) so še posebej primerne za obdelavo tankega jekla in so namenjene grobem brušenju ter tudi končni obdelavi in poliranju. Brusilni lističi se palnjačasto prekrivajo in so nameščeni na kvalitetno ploščo iz steklenih vlaken. Najpomembnejše lastnosti lamelnih brusilnih plošč so: visoka in konstantna stopnja brušenja pri nizki temperaturi, visoka kakovost obdelane površine, dolga življenjska doba, nizka raven hrupa. Uporaba: odstranjevanje rje, čiščenje odlitkov, posnemanje robov, brušenje po robovih, odstranjevanje rje/kita, končna obdelava.



Koda	Brusilna plošča (Ø) (mm)	Luknja brusilne plošče (Ø) (mm)	Zrnatost	Največje število obratov (min <sup>-1</sup> )	Cena z DDV
D-63432	115	22,23	A40	13.300	
D-63448	115	22,23	A60	13.300	
D-63454	115	22,23	A80	13.300	
D-63460	115	22,23	A80	13.300	
P-65137	115	22,23	A40	13.300	
P-65143	115	22,23	A60	13.300	
P-65159	115	22,23	A80	13.300	
P-65165	115	22,23	A120	13.300	
D-63476	125	22,23	A40	12.250	
D-63482	125	22,23	A60	12.250	
D-63498	125	22,23	A80	12.250	
D-63507	125	22,23	A120	12.250	
P-65171	125	22,23	A40	12.000	
P-65187	125	22,23	A60	12.000	
P-65193	125	22,23	A80	12.000	

[Nadaljevanje...](#)

Akumulat orji in polnilniki  
 Pribor za akumulat orsko orodje  
 Akumulat orske svetilke in pribor  
 Pribor za laserske merilnike  
 Pribor za rušenje in vrtanje  
 Pribor za vrtanje  
 Kronske žage  
 Pribor za vijachenje  
 Pribor za rezanje in brušenje  
 Pribor za poliranje in brušenje  
 Pribor za rezkanje in oblanje  
 Pribor za multitank cjsko orodje  
 Pribor za žaganje  
 Pribor za žebjalnike in spenjalnike  
 Pribor za fene  
 Pribor za sesanje  
 Pribor orodja za uporabo na prostem  
 Pribor za varnostne oprema  
 Kovčki in torbe za orodje  
 Ročno orodje  
 Razno  
 Pribor za mešanje



# Pribor za rezanje in brušenje

Koda	Brusilna plošča (Ø) (mm)	Luknja brusilne plošče (Ø) (mm)	Zrnatost	Največje število obratov (min <sup>-1</sup> )	Cena z DDV
P-65202	125	22,23	A120	12.000	
P-65224	150	22,23	A60	10.200	
D-63513	180	22,23	A40	8.500	
D-63529	180	22,23	A60	8.500	
D-63535	180	22,23	A80	8.500	
D-63541	180	22,23	A120	8.500	
P-65252	180	22,23	A40	8.600	
P-65268	180	22,23	A60	8.600	
P-65274	180	22,23	A80	8.600	
P-65280	180	22,23	A120	8.600	

## Lamelne brusilne plošče za barvne kovine - oksidna keramika

Narejena iz keramičnega korunda (Ce) - najboljšega abraziva za uporabo na zahtevnih, visoko nateznih materialih. Idealna za zahtevno brušenje materialov pod velikim pritiskom in vročino. Podloga iz ogljikovih vlaken iz naslednje generacije cirkonijevga korunda je elita med lamelnimi brusnimi ploščami. Je lahka, upogljiva in omogoča tiho delovanje. Brusi tako učinkovito kot abrazivna brusilna plošča. Primerna za: titan, nikelj, jeklo, visoki natezno jeklo, proizvodnjo delov v avtomobilizmu, letalski industriji, odstranjevanje rje in glajenje ostrih robov. Idealna za nerjavno jeklo in kovine.



Koda	Brusilna plošča (Ø) (mm)	Luknja brusilne plošče (Ø) (mm)	Zrnatost	Opis	Cena z DDV
D-28298	115	22,23	Ce40	kotna	
D-28307	115	22,23	Ce60	kotna	
D-28313	115	22,23	Ce80	kotna	
D-28329	115	22,23	Ce120	kotna	
D-28450	115	22,23	Ce40	ravna	
D-28466	115	22,23	Ce60	ravna	
D-28472	115	22,23	Ce80	ravna	
D-28488	115	22,23	Ce120	ravna	
D-28335	125	22,23	Ce40	kotna	
D-28341	125	22,23	Ce60	kotna	
D-28357	125	22,23	Ce80	kotna	
D-28363	125	22,23	Ce120	kotna	
D-28494	125	22,23	Ce40	ravna	
D-28503	125	22,23	Ce60	ravna	
D-28519	125	22,23	Ce80	ravna	
D-28525	125	22,23	Ce120	ravna	
D-28379	180	22,23	Ce40	kotna	
D-28385	180	22,23	Ce60	kotna	
D-28391	180	22,23	Ce80	kotna	
D-28400	180	22,23	Ce120	kotna	
D-28531	180	22,23	Ce40	ravna	
D-28547	180	22,23	Ce60	ravna	
D-28553	180	22,23	Ce80	ravna	
D-28569	180	22,23	Ce120	ravna	



## Lamelne brusilne plošče za končno obdelavo - steklena vlakna



Koda	Brusilna plošča (Ø) (mm)	Luknja brusilne plošče (Ø) (mm)	Zrnatost plošče	Opis	Največje število obratov (min <sup>-1</sup> )	Cena z DDV
B-40755	115	22,23	groba	kotna	12.000	
B-40761	115	22,23	srednje groba	kotna	12.000	
B-40777	115	22,23	fina	kotna	12.000	
B-40783	115	22,23	zelo fina	kotna	12.000	
B-40799	125	22,23	groba	kotna	12.000	
B-40808	125	22,23	srednje groba	kotna	12.000	
B-40814	125	22,23	fina	kotna	12.000	
B-40820	125	22,23	zelo fina	kotna	12.000	
B-40836	180	22,23	groba	kotna	8.500	
B-40842	180	22,23	srednje groba	kotna	8.500	
B-40858	180	22,23	fina	kotna	8.500	
B-40864	180	22,23	zelo fina	kotna	8.500	
B-40917	115	22,23	groba	ravna	12.000	
B-40923	115	22,23	srednje groba	ravna	12.000	
B-40939	115	22,23	fina	ravna	12.000	
B-40945	115	22,23	zelo fina	ravna	12.000	
B-40951	125	22,23	groba	ravna	12.000	
B-40967	125	22,23	srednje groba	ravna	12.000	
B-40973	125	22,23	fina	ravna	12.000	
B-40989	125	22,23	zelo fina	ravna	12.000	
B-40995	180	22,23	groba	ravna	8.500	
B-41006	180	22,23	srednje groba	ravna	8.500	
B-41012	180	22,23	fina	ravna	8.500	
B-41028	180	22,23	zelo fina	ravna	8.500	

Akumulat  
orji in  
polnilniki

Pribor za  
akumulat  
orsko  
orodje

Akumulat  
orske  
svetilke  
in pribor

Pribor za  
laserske  
merilnike

Pribor za  
rušenje  
in vrtanje

Pribor za  
vrtanje

Kronске  
žage

Pribor za  
vijačenje

Pribor za  
rezanje  
in  
brušenje

Pribor za  
poliranje  
in  
brušenje

Pribor za  
rezkanje  
in  
oblanje

Pribor za  
multifunk  
cijsko  
orodje

Pribor za  
žaganje

Pribor za  
žebjalnike  
in  
spenjalnike

Pribor za  
fene

Pribor za  
sesanje

Pribor  
orodja za  
uporabo  
na prostem

Pribor za  
ročno  
orodje in  
zaščitna  
oprema

Kovčki in  
torbe za  
orodje

Ročno  
orodje

Razno

Pribor za  
mešanje

## ŽIČNE KRTAČE ZA KOTNE BRUSILNIKE

### OBLIKA KRTAČE

Lončasta oblika



Za ravne in razbrazdane površine.

Kolutna oblika



Primerna za točkovno obdelavo.

Stožčasta oblika

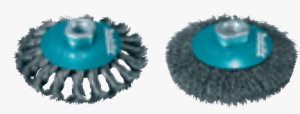

Idealna za obdelavo robov in vogalov.

### MATERIAL ŠČETIN

Jeklo

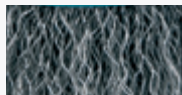

Idealne za odstranjevanje rje.

Jeklo (prevlečeno z medenino)

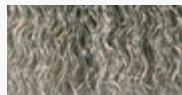

Idealne za obdelavo kovin. Odporne na rjo.

Nerjaveče jeklo

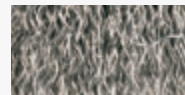

Idealne za obdelavo nerjavečih kovin. Odporne na rjo, visoke temperature in korozijo.

### TIP ŠČETIN

Valovita žica

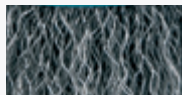

Idealna za odstranjevanje rje.

Pletena žica

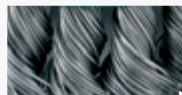

Idealna za zahtevna dela.



\*Dodaten kovinski obroč na vznožju ščetin preprečuje njihovo razmikanje in s tem zagotavlja visoko učinkovitost pri konstantnem zahtevnem delu.

## ŽIČNE IN NAJLONSKE KRTAČE ZA VRTALNIKE

### OBLIKA KRTAČE

Lončasta oblika



Primerna za ravne ali razgibane površine.

Kolutna oblika



Primerna za točkovno obdelavo.

Čopičasta oblika



Primerna za tesna in ozka mesta.

Ploščata oblika

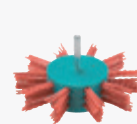

Primerna za obdelavo lesa.

### MATERIAL ŠČETIN

	Jeklo	Jeklo	Jeklo (prevlečeno z medenino)	Najlonske grobe (#80)	Najlonske fine (#240)
Tip krtiče	 Pletena	 Valovita	 Valovita	 Valovita	 Valovita
Uporaba	Idealne za obdelavo kovin.	Idealne za obdelavo kovin in za odstranjevanje rje.	Idealne za obdelavo kovin in lesa. Odporne na rjo.	Idealne za odstranjevanje rje/barve, čiščenje in pripravo površin. Primerna za kovine, les in plastiko.	Idealne za obdelavo površin iz kovine, lesa in plastike.
Končna površina	Zelo groba	Groba	Groba	Fina	Zelo fina
Kovina	★★	★★	★★	★★	★★
Les	×	×	★	★★	★★
Plastika	×	×	×	★★	★★

★★ Priporočeno ★ Sprejemljivo × Odsvetujemo

## Žične krtače za kotne brusilnike



### Lončaste žične krtače - jeklena, pletena žica

0,5 mm jeklena pletena žica (odlična za opravljanje težjih opravil – za hitro čiščenje večjih površin). D-29290, D-24153: 0,5 mm jeklena pletena dvojna žica (odlična za posebej zahtevna opravila, močnejše pletena kot jeklena pletena žica pri ostalih krtačah).



Koda	Premer ščetke (Ø) (mm)	Število ščetk	Premer žice (Ø) (mm)	Največje število obratov (min <sup>-1</sup> )	Vpetje	Za model	Cena z DDV
D-24119	60	16	0,5	12.500	M14	125, 150 mm kotni brusilniki	
D-24153	60	18	0,5	12.500	M14	125, 150 mm kotni brusilniki	
P-04488	65	18	0,5	12.500	M14	125, 150 mm kotni brusilniki	
D-24131	75	18	0,5	12.500	M14	125, 150 mm kotni brusilniki	
D-73330	80	18	0,5	12.500	X-LOCK	X-LOCK kotni brusilniki	
D-73374	80	18	0,35	12.500	X-LOCK	X-LOCK kotni brusilniki	
D-73380	80	18	0,5	12.500	X-LOCK	X-LOCK kotni brusilniki	
D-29290	100	26	0,5	8.500	M14	180, 230 mm kotni brusilniki	
P-04472	100	26	0,5	8.500	M14	180, 230 mm kotni brusilniki	



### Lončaste žične krtače - jeklena, valovita žica

0,3 mm jeklena valovita žica (odlična za manjše odstranjevanje rje z ravnih površin in robov).



Koda	Premer ščetke (Ø) (mm)	Premer žice (Ø) (mm)	Največje število obratov (min <sup>-1</sup> )	Vpetje	Za model	Cena z DDV
D-24072	60	0,3	12.500	M14	125, 150 mm kotni brusilniki	
D-24094	75	0,3	12.500	M14	125, 150 mm kotni brusilniki	
D-73346	75	0,3	12.500	X-LOCK	X-LOCK kotni brusilniki	
D-73396	75	0,3	12.500	X-LOCK	X-LOCK kotni brusilniki	
D-29284	100	0,3	8.500	M14	180, 230 mm kotni brusilniki	

- Akumulat orji in polnilniki
- Pribor za akumulat orsko orodje
- Akumulat orske svetilke in pribor
- Pribor za laserske merilnike
- Pribor za rušenje in vrtanje
- Pribor za vrtanje
- Kronске žage
- Pribor za vijačenje
- Pribor za rezanje in brušenje
- Pribor za poliranje in brušenje
- Pribor za rezkanje in oblanje
- Pribor za multitfunkcijsko orodje
- Pribor za žaganje
- Pribor za žebjalnike in spenjalnike
- Pribor za fene
- Pribor za sesanje
- Pribor orodja za uporabo na prostem
- Pribor za čiščenje orodja in zaščitna oprema
- Kovčki in torbe za orodje
- Ročno orodje
- Razno
- Pribor za mešanje



### Kolutne žične krtače - jeklena, pletena žica

0,5 mm jeklena pletena žica (učinkovita pri zahtevnejšem čiščenju manjše površine).



Koda	Premer ščetke (Ø) (mm)	Število ščetk	Premer žice (Ø) (mm)	Največje število obratov (min <sup>-1</sup> )	Vpetje	Za model	Cena z DDV
D-29555	100	18	0,5	8.500	M14	125, 150, 180, 230 mm kotni brusilniki	
D-29561	115	20	0,5	8.500	M14	125, 150, 180, 230 mm kotni brusilniki	
D-73352	115	20	0,5	12.500	X-LOCK	X-LOCK kotni brusilniki	
D-73368	115	30	0,5	12.500	X-LOCK	X-LOCK kotni brusilniki	
D-73405	115	20	0,5	12.500	X-LOCK	X-LOCK kotni brusilniki	
D-73411	115	30	0,5	12.500	X-LOCK	X-LOCK kotni brusilniki	
D-29577	125	22	0,5	8.500	M14	125, 150, 180, 230 mm kotni brusilniki	



### Stožčaste žične krtače - jeklena, pletena žica

0,5 mm jeklena pletena žica (učinkovita za čiščenje robov in vogalov).



Koda	Premer ščetke (Ø) (mm)	Število ščetk	Premer žice (Ø) (mm)	Največje število obratov (min <sup>-1</sup> )	Vpetje	Za model	Cena z DDV
D-39861	100	18	0,5	12.500	M14	125, 150, 180, 230 mm kotni brusilniki	
P-04494	100	18	0,5	12.500	M14	180, 230 mm kotni brusilniki	
D-39883	115	18	0,5	12.500	M14	125, 150, 180, 230 mm kotni brusilniki	



### Stožčaste žične krtače - jeklena, valovita žica

0,3 mm jeklena valovita žica (posebej primerna za čiščenje stranskih površin).



Koda	Premer ščetke (Ø) (mm)	Premer žice (Ø) (mm)	Največje število obratov (min <sup>-1</sup> )	Vpetje	Za model	Cena z DDV
D-39827	100	0,3	12.500	M14	125, 150, 180, 230 mm kotni brusilniki	

[Nadaljevanje...](#)



# Pribor za rezanje in brušenje

Koda	Premer ščetke (Ø) (mm)	Premer žice (Ø) (mm)	Največje število obratov (min <sup>-1</sup> )	Vpetje	Za model	Cena z DDV
D-73449	100	0,3	12.500	X-LOCK	X-LOCK kotni brusilniki	
D-39849	115	0,3	12.500	M14	125, 150, 180, 230 mm kotni brusilniki	
D-73427	115	0,3	12.500	X-LOCK	X-LOCK kotni brusilniki	



## Lončaste žične krtače - medenina, valovita žica

0,3 mm medeninasta valovita žica (odlična za manjše odstranjevanje rje; žica je zaščitena pred korozijo).



Koda	Premer ščetke (Ø) (mm)	Premer žice (Ø) (mm)	Največje število obratov (min <sup>-1</sup> )	Vpetje	Za model	Cena z DDV
D-39746	60	0,3	12.500	M14	125, 150 mm kotni brusilniki	
D-39768	75	0,3	12.500	M14	125, 150 mm kotni brusilniki	
D-73433	75	0,3	12.500	X-LOCK	X-LOCK kotni brusilniki	
D-39780	90	0,3	8.500	M14	180, 230 mm kotni brusilniki	
D-39805	100	0,3	8.500	M14	180, 230 mm kotni brusilniki	

## Žične krtače za vrtalnike



## Lončaste žične krtače - jeklena, pletena žica



Koda	Premer ščetke (Ø) (mm)	Premer žice (Ø) (mm)	Največje število obratov (min <sup>-1</sup> )	Vpetje	Cena z DDV
D-73798	63	0,5	4.500	6 mm	
D-73807	75	0,5	4.500	6 mm	

- Akumulat orji in polnilniki
- Pribor za akumulat orsko svetilke in pribor
- Akumulat orske svetilke in pribor
- Pribor za laserske merilnike
- Pribor za rušenje in vrtanje
- Pribor za vrtanje
- Kronske žage
- Pribor za vijačenje
- Pribor za rezanje in brušenje
- Pribor za poliranje in brušenje
- Pribor za rezkanje in oblanje
- Pribor za multitank cirkosno orodje
- Pribor za žaganje
- Pribor za žebjalnike in spenjalnike
- Pribor za fene
- Pribor za sesanje
- Pribor orodja za uporabo na prostem
- Pribor za ploščanje orodja in zaščitna oprema
- Kovčki in torbe za orodje
- Ročno orodje
- Razno
- Pribor za mešanje



### Kolutne žične krtače - jeklena, pletena žica



Koda	Premer ščetke (Ø) (mm)	Premer žice (Ø) (mm)	Največje število obratov (min <sup>-1</sup> )	Vpetje	Cena z DDV
D-73813	75	0,5	4.500	6 mm	
D-73829	100	0,5	4.500	6 mm	



### Čopičaste žične krtače - jeklena, pletena žica



Koda	Premer ščetke (Ø) (mm)	Premer žice (Ø) (mm)	Največje število obratov (min <sup>-1</sup> )	Vpetje	Cena z DDV
D-73835	12	0,5	4.500	6 mm	
D-73841	19	0,5	4.500	6 mm	
D-73857	24	0,5	4.500	6 mm	
D-73863	28	0,5	4.500	6 mm	



### Lončaste žične krtače - pločevinasta, valovita žica

Primerne za odstranjevanje rje, čiščenje opažnih desk, posnemanje robov in za odstranjevanje premazov in barv.



Koda	Premer ščetke (Ø) (mm)	Premer žice (Ø) (mm)	Največje število obratov (min <sup>-1</sup> )	Vpetje	Cena z DDV
D-39908	38	0,3	4.500	6 mm	
D-39914	50	0,3	4.500	6 mm	
D-39920	63	0,3	4.500	6 mm	
D-39936	75	0,3	4.500	6 mm	
D-39942	80	0,3	4.500	6 mm	



## Kolutne žične krtače - pločevinasta, valovita žica

Primerne za odstranjevanje rje, čiščenje, odstranjevanje prevlek in barve na težko dostopnih mestih.



Koda	Premer ščetke (Ø) (mm)	Premer žice (Ø) (mm)	Največje število obratov (min <sup>-1</sup> )	Vpetje	Cena z DDV
D-39958	38	0,3	4.500	6 mm	
D-39964	50	0,3	4.500	6 mm	
D-39970	63	0,3	4.500	6 mm	
D-39986	75	0,3	4.500	6 mm	
D-39992	100	0,3	4.500	6 mm	



## Čopičaste žične krtače - pločevinasta, valovita žica

Primerne za odstranjevanje rje, barve, lakov in za čiščenje površin v tesnih prostorih.



Koda	Premer ščetke (Ø) (mm)	Premer žice (Ø) (mm)	Največje število obratov (min <sup>-1</sup> )	Vpetje	Cena z DDV
D-40004	12	0,3	4.500	6 mm	
D-40010	19	0,3	4.500	6 mm	
D-40026	25	0,3	4.500	6 mm	
D-40032	30	0,3	4.500	6 mm	



## Seti

Koda	Premer ščetke (Ø) (mm)	Premer žice (Ø) (mm)	Največje število obratov (min <sup>-1</sup> )	Vpetje	Cena z DDV
D-65729	63, 75, 75, 100	0,3	4.500	6 mm	

- Akumulat orji in polnilniki
- Pribor za akumulat orsko orodje
- Akumulat orske svetilke in pribor
- Pribor za laserske merilnike
- Pribor za rušenje in vrtanje
- Pribor za vrtanje
- Kronske žage
- Pribor za vijačenje
- Pribor za rezanje in brušenje
- Pribor za poliranje in brušenje
- Pribor za rezkanje in oblanje
- Pribor za multitank cliko orodje
- Pribor za žaganje
- Pribor za žebjalnike in spenjalnike
- Pribor za fene
- Pribor za sesanje
- Pribor orodja za uporabo na prostem
- Pribor za ploščne orodja in zaščitna oprema
- Kovčki in torbe za orodje
- Ročno orodje
- Razno
- Pribor za mešanje



### Lončaste žične krtače - medeninasta, valovita žica



Koda	Premer ščetke (Ø) (mm)	Premer žice (Ø) (mm)	Največje število obratov (min <sup>-1</sup> )	Vpetje	Cena z DDV
D-73601	38	0,3	4.500	1/4"	
D-73617	50	0,3	4.500	1/4"	
D-73623	63	0,3	4.500	1/4"	
D-73639	75	0,3	4.500	1/4"	
D-73645	80	0,3	4.500	1/4"	



### Kolutne žične krtače - medeninasta, valovita žica



Koda	Premer ščetke (Ø) (mm)	Premer žice (Ø) (mm)	Največje število obratov (min <sup>-1</sup> )	Vpetje	Cena z DDV
D-73651	38	0,3	4.500	1/4"	
D-73667	50	0,3	4.500	1/4"	
D-73673	63	0,3	4.500	1/4"	
D-73689	75	0,3	4.500	1/4"	
D-73695	100	0,3	4.500	1/4"	



### Čopičaste žične krtače - medeninasta, valovita žica









Koda	Premer ščetke (Ø) (mm)	Premer žice (Ø) (mm)	Največje število obratov (min <sup>-1</sup> )	Vpetje	Cena z DDV
D-73704	12	0,3	4.500	1/4"	
D-73710	19	0,3	4.500	1/4"	
D-73726	24	0,3	4.500	1/4"	
D-73732	28	0,3	4.500	1/4"	

## Najlonske krtače za vrtalnike

### Najlonske lončaste krtače

Idealno za odstranjevanje rje in barve na kovini, lesu in plastiki.





Koda	Premer (Ø) (mm)	Največje število obratov (min <sup>-1</sup> )	Zrnatost	Vpetje (mm)	Tip ščetke	Cena z DDV	
D-45509	50	4.500	80	6	groba		
D-45537	50	4.500	240	6	fina		
D-45515	63	4.500	80	6	groba		
D-45543	63	4.500	240	6	fina		
D-45521	75	4.500	80	6	groba		
D-45559	75	4.500	240	6	fina		

### Najlonske kolutne krtače

Idealno za odstranjevanje rje in barve na kovini, lesu in plastiki.



Koda	Premer (Ø) (mm)	Največje število obratov (min <sup>-1</sup> )	Zrnatost	Vpetje (mm)	Tip ščetke	Cena z DDV	
D-45565	38	4.500	80	6	groba		
D-45618	38	4.500	240	6	fina		
D-45571	50	4.500	80	6	groba		

Nadaljevanje...

Akumulat  
orji in  
pnilniki

Pribor za  
akumulat  
orsko  
orodje

Akumulat  
orske  
svetilke  
in pribor

Pribor za  
lasarske  
mehlinike

Pribor za  
rušenje  
in vrtanje

Pribor za  
vrtanje

Kronске  
žage

Pribor za  
vijačenje

Pribor za  
rezanje  
in  
brušenje

Pribor za  
poliranje  
in  
brušenje

Pribor za  
rezkanje  
in  
oblanje

Pribor za  
multifunk  
ciljsko  
orodje

Pribor za  
žaganje

Pribor za  
žebjalnike  
in  
spenjalnike

Pribor za  
fene

Pribor za  
sesanje

Pribor  
orodja za  
uporabo  
na prostem

Pribor za  
ročje  
in  
zaščitna  
oprema

Kovčki in  
torbe za  
orodje

Ročno  
orodje

Razno

Pribor za  
mešanje





# Pribor za rezanje in brušenje

	Koda	Premer (Ø) (mm)	Največje število obratov (min <sup>-1</sup> )	Zrnatost	Vpetje (mm)	Tip ščetke	Cena z DDV
	D-45624	50	4.500	240	6	fina	
	D-45587	63	4.500	80	6	groba	
	D-45630	63	4.500	240	6	fina	
	D-45593	75	4.500	80	6	groba	
	D-45646	75	4.500	240	6	fina	
	D-45602	100	4.500	80	6	groba	
	D-45652	100	4.500	240	6	fina	

## Najlonske ploščate krtače

Idealno za odstranjevanje rje in barve na kovini, lesu in plastiki.



	Koda	Premer (Ø) (mm)	Največje število obratov (min <sup>-1</sup> )	Zrnatost	Vpetje (mm)	Tip ščetke	Cena z DDV
	D-45749	100	4.500	80	6	groba	
	D-45755	100	4.500	240	6	fina	

# Pribor za rezanje in brušenje

## Najlonske čopičaste krtače

Idealno za odstranjevanje rje in barve na kovini, lesu in plastiki.



Koda	Premer (Ø) (mm)	Največje število obratov (min <sup>-1</sup> )	Zrnatost	Vpetje (mm)	Tip ščetke	Cena z DDV	
D-45668	12	4.500	80	6	groba		
D-45705	12	4.500	240	6	fina		
D-45711	17	4.500	240	6	fina		
D-45674	19	4.500	80	6	groba		
D-45680	24	4.500	80	6	groba		
D-45727	24	4.500	240	6	fina		
D-45696	30	4.500	80	6	groba		
D-45733	30	4.500	240	6	fina		



## Seti









Koda	Premer (Ø) (mm)	Največje število obratov (min <sup>-1</sup> )	Zrnatost	Vpetje (mm)	Tip ščetke	Cena z DDV
D-70758	24, 50, 50	4.500	240	6	groba	

- Akumulat orji in polnilniki
- Pribor za akumulat orsko orodje
- Akumulat orske svetilke in pribor
- Pribor za laserske merilnike
- Pribor za rušenje in vrtanje
- Pribor za vrtanje
- Kronske žage
- Pribor za vijačenje
- Pribor za rezanje in brušenje
- Pribor za poliranje in brušenje
- Pribor za rezkanje in oblanje
- Pribor za multitank cjsko orodje
- Pribor za žaganje
- Pribor za žebjalnike in spenjalnike
- Pribor za fene
- Pribor za sesanje
- Pribor orodja za uporabo na prostem
- Pribor za ročno orodje in zaščitna oprema
- Kovčki in torbe za orodje
- Ročno orodje
- Razno
- Pribor za mešanje

## Ostali pribor za kotne brusilnike

## Prirobnice















	Koda	Naziv	Za model	Cena z DDV
	192227-7	Super prirobnica	Ø 115-230 mm	
	195354-9	EZYNUT hitrozatezna prirobna matica	Ø 180/230 mm	
	196297-8	Zatezna matica	Ø 115/230 mm	
	198678-2	Notranja prirobnica	Ø 230 mm	
	224415-9	Notranja prirobnica	Ø 115-230 mm	
	224543-0	Prirobna matica	Ø 180/230 mm	
	224554-5	Prirobna matica	Ø 115/125/150 mm	

## Protiprašne zaščite in odsesovalni nastavki

	Koda	Naziv	Za model	Primerno za	Cena z DDV
	199709-0	Zaščitni pokrov rezalne plošče 115mm	/	115 mm kotni brusilnik	
	192968-5	Odsesovalni nastavek za kotni brusilnik s spojko	/	115/125 mm kotni brusilnik	
	192972-4	Odsesovalni nastavek za kotni brusilnik brez spojke	/	115/125 mm kotni brusilnik	

[Nadaljevanje...](#)

# Pribor za rezanje in brušenje

Koda	Naziv	Za model	Primerno za	Cena z DDV	
193794-5	Odsesovalni nastavek za kotni brusilnik	/	115/125 mm kotni brusilnik		
195239-9	Protiprašni ščitnik pri brušenju	/	115/125 mm kotni brusilnik		
196845-3	Odsesovalni ščitnik za rezanje za kotne brusilnike	/	115/125 mm kotni brusilnik		
451765-1	Snemljiv robni pokrov prahu za 195239-9	/	115/125 mm kotni brusilnik		
199710-5	Zaščitni pokrov rezalne plošče 125mm	/	125 mm kotni brusilnik		
198514-2	Ščitnik s sistemom za odsesavanje 180mm	/	180 mm kotni brusilnik		
194044-1	Odsesovalni nastavek za kotni brusilnik	/	180/230 mm kotni brusilnik		
195385-8	Odsesovalni ščitnik pri brušenju 180/230mm	/	180/230 mm kotni brusilnik		
452086-4	Snemljiv robni pokrov prahu za 195385-8	/	180/230 mm kotni brusilnik		
198440-5	Ščitnik s sistemom za odsesavanje 230mm	/	230 mm kotni brusilnik		
743332-9	Ščetka (dolga) za odsesovalni ščit 195239-9	191F81-2, 195239-9	115/125 mm kotni brusilnik		
743333-7	Ščetka (kratka) za odsesovalni ščit 195239-9	191F81-2, 195239-9	115/125 mm kotni brusilnik		
743334-5	Ščetka (dolga) za odsesovalni ščit 195385-8	195385-8	180/230 mm kotni brusilnik		
743335-3	Ščetka (kratka) za odsesovalni ščit 195385-8	195385-8	180/230 mm kotni brusilnik		
192188-1	Odsesovalni nastavek za kotni brusilnik	9005B, 9005N	/		

[Nadaljevanje...](#)

Akumulator  
orj in  
poinliniki

Pribor za  
akumulator  
orsko  
orodje

Akumulator  
orske  
svetilke  
in pribor

Pribor za  
lasarske  
merilnike

Pribor za  
rušenje  
in vrtanje

Pribor za  
vrtanje

Kronske  
žage

Pribor za  
vijačenje

Pribor za  
rezanje  
in  
brušenje

Pribor za  
poliranje  
in  
brušenje

Pribor za  
rezkanje  
in  
oblanje

Pribor za  
multifunk  
ciljsko  
orodje

Pribor za  
žaganje

Pribor za  
žebjalnike  
in  
spenjalnike

Pribor za  
fene

Pribor za  
sesanje

Pribor  
orodja za  
uporabo  
na prostem

Pribor za  
ploščje  
orodja in  
zaščitna  
oprema















Kovčki in  
torbe za  
orodje

Ročno  
orodje

Razno

Pribor za  
mešanje

# Pribor za rezanje in brušenje

	Koda	Naziv	Za model	Primerno za	Cena z DDV
Akumulat orji in polnilniki					
Pribor za akumulat orsko orodje					
Akumulat orske svetilke in pribor					
Pribor za lasarske merilnike					
Pribor za rušenje in vrtanje					
Pribor za vrtanje					
Kronske žage					
Pribor za vijačenje					
Pribor za rezanje in brušenje					
Pribor za poliranje in brušenje					
Pribor za rezkanje in oblanje					
Pribor za multitank ciklno orodje					
Pribor za zaganje					
Pribor za žebjalnike in spenjalnike					
Pribor za fene					
Pribor za sesanje					
Pribor orodja za uporabo na prostem					
Pribor za nosenje orodja in zaščitna oprema					
Kovčki in torbe za orodje					
Ročno orodje					
Razno					
Pribor za mešanje					
	193903-6	Protiprašna zaščita	9564H, 9565H, 9565CR, 9565CLR, 9566CVR, GA5080R	/	
	122910-2	Zaščitni pokrov rezalne plošče 115mm	DGA450, DGA452, GA4530/R, GA4540/C/R, GA4541C/R	/	
	162708-5	Zaščitni pokrov rezalne plošče 125mm	DGA519, DGA520, DGA521	125 mm kotni brusilnik	
	191G05-4	Odsesovalni ščitnik za rezanje za kotne brusilnike X-LOCK	DGA519, DGA520, DGA521	125 mm kotni brusilnik	
	457620-5	Protiprašna zaščita	DGA900/DGA700	/	
	162557-0	Zaščitni pokrov rezalne plošče 125mm XGT	GA005G, GA008G, GA023G, GA029G, GA5050R	/	
	191F81-2	Odsesovalni ščitnik pri brušenju 125mm XGT	GA005G, GA008G, GA023G, GA029G, GA5050R	/	
	191G06-2	Odsesovalni ščitnik za kotne brusilnike 125 mm XGT	GA005G, GA008G, GA023G, GA029G, GA5050R	/	
	347480-2	Zaščitni pokrov rezalne plošče 125mm	GA005G, GA008G, GA023G, GA029G, GA5050R, GA5051R	125 mm kotni brusilnik	
	198719-4	Protiprašna zaščita	GA4540C, GA4540R, GA5040C	/	
	347479-7	Zaščitni pokrov rezalne plošče 115mm	GA4550R	115 mm kotni brusilnik	
	199514-5	Protiprašna zaščita	GA5050R, GA5051R	/	
	122914-4	Zaščitni pokrov rezalne plošče 180mm	GA7010C, GA7020/F/RF, GA7030RF01, GA7040RF01, GA7060R, GA7061R	/	
	194289-1	Protiprašna zaščita	GA7020, GA7030, GA7030S, GA7040S, GA9020, GA9030, GA9030S, GA9040S	/	

Nadaljevanje...













# Pribor za rezanje in brušenje

Koda	Naziv	Za model	Primerno za	Cena z DDV	
191T15-9	Protiprašna zaščita	GA7070, GA9070, GA9071	/		
122913-6	Zaščitni pokrov rezalne plošče 230 mm	GA9010C, GA9020/F/RF/RFK, GA9030/R/RF, GA9040R/RF, GA9050/R, GA9060R, GA9061R	/		
195059-1	Protiprašna zaščita	GA9050, GA9050R	/		

## Pribor za prebijalnike in rezalnike















### Noži za prebijalnike, rezalnike in pribor

Koda	Naziv	Za model	Enota (kos/set)	Cena z DDV	
191383-0	Štiristranski nož za škarje za pločevino	JS1600, JS1602	2/1		
725092-5	Stransko rezilo DESNO	DJS200	1		
725093-3	Stransko rezilo LEVO	DJS200	1		
725255-3	Sredinsko rezilo	DJS200	1		
725256-1	Desno rezilo	DJS131	1		
725257-9	Sredinsko rezilo	DJS131	1		
725258-7	Levo rezilo	DJS131	1		
762007-1	Merilni lističi	JS3200, JS3201	1		
762013-6	Merilni lističi	JS1660, JS1601, DJS161	1		
792264-7	Matrica	JN1600	1		

[Nadaljevanje...](#)

- Akumulat orji in polnilniki
- Pribor za akumulat orsko orodje
- Akumulat orske svetilke in pribor
- Pribor za lasarske merilnike
- Pribor za rušenje in vrtanje
- Pribor za vrtanje
- Kronske žage
- Pribor za vijačenje
- Pribor za rezanje in brušenje
- Pribor za poliranje in brušenje
- Pribor za rezkanje in oblanje
- Pribor za multitank ciklo orodje
- Pribor za žaganje
- Pribor za žebjalnike in spenjalnike
- Pribor za fene
- Pribor za sesanje
- Pribor orodja za uporabo na prostem
- Pribor za nožje orodja in zaščitna oprema
- Kovčki in torbe za orodje
- Ročno orodje
- Razno
- Pribor za mešanje

# Pribor za rezanje in brušenje

	Koda	Naziv	Za model	Enota (kos/set)	Cena z DDV	
Akumulat orji in polnilniki		792265-5	Luknjač	JN1600	1	
Pribor za akumulat orsko orodje		792287-5	Štiristranski nož za skarje za pločevino	JS3200, JS3201	2/1	
Akumulat orske svetilke in pribor		792292-2	Matrica	JN3200	1	
Pribor za laserske merilnike		792367-7	Rezilni nož	JS1650	1	
Pribor za rušenje in vrtanje		792368-5	Stranski nož	JS1650	1	
Pribor za vrtanje		792533-6	Stranski nož	DJS160, DJS161, JS1660, JS1601	2/1	
Kronske žage		792534-4	Rezilni nož	JS1660, JS1601, DJS161	1	
Pribor za vijlačenje		792536-0	Stranski nož	DJS100, DJS101, JS1670, BJS101RFE, JS1000	2/1	
Pribor za rezanje in brušenje		792537-8	Rezilni nož	JS1670, BJS101RFE, JS1000	1	
Pribor za poliranje in brušenje		792728-1	Luknjač	JN3200, JN3201	1	
Pribor za rezkanje in oblanje		792742-7	Stranski nož, desni	DJS130, JS1300	1	
Pribor za multitank cijsko orodje		792743-5	Stranski nož, levi	DJS130, JS1300	1	
Pribor za žabljanke in spenjalnike		792744-3	Rezilni nož	DJS130, JS1300	1	
Pribor za fene		A-15051	Matrica	JN1601, DJN161	1	
Pribor za sesanje		A-83951	Luknjač	JN1601, DJN161	1	

Pribor za orodja za uporabo na prostem

Pribor za nosenje orodja in zaščita oprema

Kovčki in torbe za orodje

Ročno orodje

Razno

Pribor za mešanje

# PRIBOR ZA POLIRANJE IN BRUŠENJE

Naravni kamen



Malta



Kovine



Aluminij



Nerjavno jeklo



Barvne kovine



Steklo



Plastika, PVC



Les z žebli



Les



Odstranjevanje barve



Zaključna dela



Barvane in lakirane površine



Pritrjevanje na ježka



Aluminijev oksid

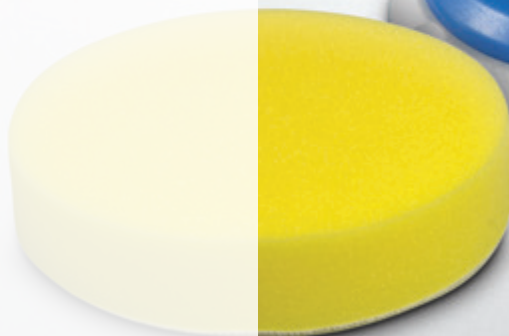
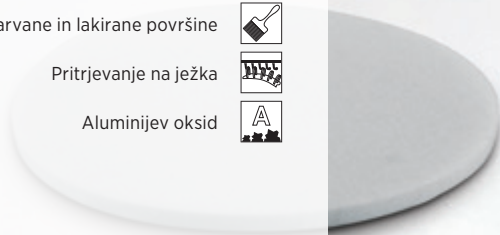

## Tračni brusilniki

## Brusni trak

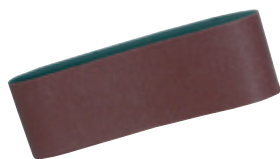
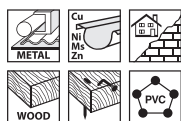

Koda	Dimenzija	Zrnatost	Enota (kos/set)
P-37091	76 × 457 mm	40	5/1
P-37100	76 × 457 mm	60	5/1
P-37116	76 × 457 mm	80	5/1
P-37122	76 × 457 mm	100	5/1
P-37138	76 × 457 mm	120	5/1
P-37144	76 × 457 mm	150	5/1
P-37150	76 × 457 mm	240	5/1
P-37166	76 × 457 mm	60/80/120	3/1
P-37172	76 × 533 mm	40	5/1
P-37247	76 × 533 mm	40	25/1
P-43393	76 × 533 mm	40	50/1
P-37188	76 × 533 mm	60	5/1
P-37253	76 × 533 mm	60	25/1
P-43402	76 × 533 mm	60	50/1
P-37194	76 × 533 mm	80	5/1
P-37269	76 × 533 mm	80	25/1
P-43418	76 × 533 mm	80	50/1
P-37203	76 × 533 mm	100	5/1
P-37275	76 × 533 mm	100	25/1
P-43424	76 × 533 mm	100	50/1
P-37219	76 × 533 mm	120	5/1
P-37281	76 × 533 mm	120	25/1
P-43430	76 × 533 mm	120	50/1
P-37225	76 × 533 mm	150	5/1
P-37297	76 × 533 mm	150	25/1
P-43446	76 × 533 mm	150	50/1
P-37231	76 × 533 mm	240	5/1
P-37306	76 × 533 mm	240	25/1
P-43452	76 × 533 mm	240	50/1
P-37312	76 × 610 mm	40	5/1
P-51144	76 × 610 mm	40	25/1
P-37328	76 × 610 mm	60	5/1
P-51150	76 × 610 mm	60	25/1
P-37334	76 × 610 mm	80	5/1
P-51164	76 × 610 mm	80	25/1
P-37340	76 × 610 mm	100	5/1
P-51172	76 × 610 mm	100	25/1
P-37356	76 × 610 mm	120	5/1
P-51188	76 × 610 mm	120	25/1
P-37362	76 × 610 mm	150	5/1
P-51194	76 × 610 mm	150	25/1
P-37378	76 × 610 mm	240	5/1
P-51203	76 × 610 mm	240	25/1
P-36740	100 × 560 mm	40	5/1
P-36756	100 × 560 mm	60	5/1
P-36762	100 × 560 mm	80	5/1
P-36837	100 × 560 mm	80	25/1
P-36778	100 × 560 mm	100	5/1
P-36784	100 × 560 mm	120	5/1
P-36859	100 × 560 mm	120	25/1
P-36790	100 × 560 mm	150	5/1

P-36809	100 × 560 mm	240	5/1
P-36887	100 × 610 mm	40	5/1
P-36952	100 × 610 mm	40	25/1
P-36893	100 × 610 mm	60	5/1
P-36968	100 × 610 mm	60	25/1
P-36902	100 × 610 mm	80	5/1
P-36974	100 × 610 mm	80	25/1
P-36918	100 × 610 mm	100	5/1
P-36980	100 × 610 mm	100	25/1
P-43496	100 × 610 mm	100	50/1
P-36924	100 × 610 mm	120	5/1
P-36996	100 × 610 mm	120	25/1
P-36930	100 × 610 mm	150	5/1
P-37007	100 × 610 mm	150	25/1
P-43511	100 × 610 mm	150	50/1
P-36946	100 × 610 mm	240	5/1
P-37013	100 × 610 mm	240	25/1
P-43527	100 × 610 mm	240	50/1
P-37029	100 × 620 mm	40	5/1
P-37035	100 × 620 mm	60	5/1
P-37041	100 × 620 mm	80	5/1
P-37057	100 × 620 mm	100	5/1
P-37063	100 × 620 mm	120	5/1
P-37079	100 × 620 mm	150	5/1
P-43181	6 × 533 mm	40	5/1
P-43197	6 × 533 mm	60	5/1
P-43206	6 × 533 mm	80	5/1
P-43212	6 × 533 mm	100	5/1
P-43228	6 × 533 mm	120	5/1
P-43234	6 × 533 mm	150	5/1
P-43240	6 × 533 mm	240	5/1
P-43256	9 × 533 mm	40	5/1
P-43262	9 × 533 mm	60	5/1
P-43278	9 × 533 mm	80	5/1
P-43284	9 × 533 mm	100	5/1
P-43290	9 × 533 mm	120	5/1
P-43321	13 × 533 mm	40	5/1
P-43337	13 × 533 mm	60	5/1
P-43343	13 × 533 mm	80	5/1
P-43359	13 × 533 mm	100	5/1
P-43365	13 × 533 mm	120	5/1
P-43371	13 × 533 mm	150	5/1
P-43387	13 × 533 mm	240	5/1
P-36675	30 × 533 mm	40	5/1
A-23852	30 × 533 mm	40	10/1
P-36681	30 × 533 mm	60	5/1
A-23868	30 × 533 mm	60	10/1
P-36697	30 × 533 mm	80	5/1
A-23874	30 × 533 mm	80	10/1
P-36706	30 × 533 mm	100	5/1
A-23880	30 × 533 mm	100	10/1
P-36712	30 × 533 mm	120	5/1
A-23896	30 × 533 mm	120	10/1
P-36728	30 × 533 mm	150	5/1
P-36734	30 × 533 mm	240	5/1

# Pribor za poliranje in brušenje

## Brusni trak za steklo



Koda	Dimenzija	Zrnatost	Enota (kos/set)
P-01395	30 × 533 mm	40	5/1
P-01404	30 × 533 mm	60	5/1
P-01199	30 × 533 mm	80	5/1
P-01208	30 × 533 mm	100	5/1
P-01214	30 × 533 mm	120	5/1
P-01236	30 × 533 mm	180	5/1

P-37409	125 mm	80	50/1
P-33370	125 mm	100	10/1
P-33386	125 mm	120	10/1
P-37421	125 mm	120	50/1
P-33392	125 mm	180	10/1
P-33401	125 mm	240	10/1
P-33417	125 mm	320	10/1
P-33423	125 mm	400	10/1
P-37465	125 mm	400	50/1

S pritrevanjem na ježka.

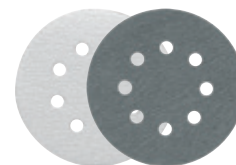
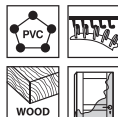

Koda	Premer	Zrnatost	Enota (kos/set)
D-65816	125 mm	40	10/1
D-65822	125 mm	60	10/1
D-65838	125 mm	80	10/1
D-65844	125 mm	100	10/1
D-65850	125 mm	120	10/1
D-65866	125 mm	150	10/1
D-65872	125 mm	180	10/1
D-65888	125 mm	240	10/1
D-65894	125 mm	320	10/1
D-65903	125 mm	400	10/1

## Ekscentrični brusilniki

### Brusni papir - 8 lukenj

S pritrevanjem na ježka.

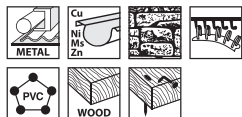

Koda	Premer	Zrnatost	Enota (kos/set)
P-43533	125 mm	40	10/1
P-43620	125 mm	40	50/1
P-43549	125 mm	60	10/1
P-43636	125 mm	60	50/1
P-43555	125 mm	80	10/1
P-43642	125 mm	80	50/1
P-43561	125 mm	100	10/1
P-43658	125 mm	100	50/1
P-43577	125 mm	120	10/1
P-43664	125 mm	120	50/1
P-43583	125 mm	180	10/1
P-43670	125 mm	180	50/1
P-43599	125 mm	240	10/1
P-43686	125 mm	240	50/1
P-43608	125 mm	320	10/1
P-43692	125 mm	320	50/1
P-43614	125 mm	400	10/1

### Brusni papir - 6 lukenj

S pritrevanjem na ježka.

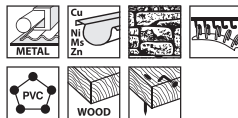

Koda	Premer	Zrnatost	Enota (kos/set)
P-37471	150 mm	40	10/1
P-37568	150 mm	40	50/1
P-37487	150 mm	60	10/1
P-37574	150 mm	60	50/1
P-37493	150 mm	80	10/1
P-37580	150 mm	80	50/1
P-37502	150 mm	100	10/1
P-37596	150 mm	100	50/1
P-37518	150 mm	120	10/1
P-37605	150 mm	120	50/1
P-37524	150 mm	180	10/1
P-37611	150 mm	180	50/1
P-37530	150 mm	240	10/1
P-37627	150 mm	240	50/1
P-37546	150 mm	320	10/1
P-37633	150 mm	320	50/1
P-37552	150 mm	400	10/1
P-37649	150 mm	400	50/1

S pritrevanjem na ježka.



Koda	Premer	Zrnatost	Enota (kos/set)
P-33342	125 mm	40	10/1
P-37384	125 mm	40	50/1
P-33358	125 mm	60	10/1
P-37390	125 mm	60	50/1
P-33364	125 mm	80	10/1

Akumulat orji in polnilniki  
 Pribor za akumulat orsko svetilke in pribor  
 Pribor za lasarske merilnike  
 Pribor za rušenje in vrtnanje  
 Pribor za vrtnanje  
 Kronske žage  
 Pribor za vijachenje  
 Pribor za rezanje in brušenje  
 Pribor za poliranje in brušenje  
 Pribor za rezkanje in oblanje  
 Pribor za multifunkcijsko orodje  
 Pribor za zaganje  
 Pribor za žebjalnike in spenjalnike  
 Pribor za fene  
 Pribor za sesanje  
 Pribor orodja za uporabo na prostem  
 Pribor za nosenje orodja za zaščita oprema  
 Kovčki in torbe za orodje  
 Ročno orodje  
 Razno  
 Pribor za mešanje



# Pribor za poliranje in brušenje

S pritnjevanjem na ježka.

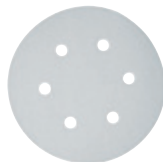

Koda	Premer	Zrnatost	Enota (kos/set)
P-37655	150 mm	40	10/1
P-37742	150 mm	40	50/1
P-37661	150 mm	60	10/1
P-37758	150 mm	60	50/1
P-37677	150 mm	80	10/1
P-37764	150 mm	80	50/1
P-37683	150 mm	100	10/1
P-37770	150 mm	100	50/1
P-37699	150 mm	120	10/1
P-37786	150 mm	120	50/1
P-37708	150 mm	180	10/1
P-37792	150 mm	180	50/1
P-37714	150 mm	240	10/1
P-37801	150 mm	240	50/1
P-37720	150 mm	320	10/1
P-37817	150 mm	320	50/1
P-37736	150 mm	400	10/1
P-37823	150 mm	400	50/1

S pritnjevanjem na ježka.



Koda	Premer	Zrnatost	Enota (kos/set)
P-37839	150 mm	40	10/1
P-37948	150 mm	40	50/1
P-37845	150 mm	60	10/1
P-37851	150 mm	80	10/1
P-37960	150 mm	80	50/1
P-37867	150 mm	100	10/1
P-37976	150 mm	100	50/1
P-37873	150 mm	120	10/1
P-37982	150 mm	120	50/1
P-37889	150 mm	150	10/1
P-37895	150 mm	180	10/1
P-37998	150 mm	180	50/1
P-37910	150 mm	240	10/1
P-38009	150 mm	240	50/1
P-37926	150 mm	320	10/1
P-38015	150 mm	320	50/1
P-37932	150 mm	400	10/1
P-38021	150 mm	400	50/1

## Brusni papir - 9 lukenj

S pritnjevanjem na ježka.



Koda	Premer	Zrnatost	Enota (kos/set)
P-31918	150 mm	40	10/1
P-32574	150 mm	40	50/1
P-31924	150 mm	60	10/1
P-32580	150 mm	60	50/1
P-31930	150 mm	80	10/1
P-32596	150 mm	80	50/1
P-31946	150 mm	100	10/1
P-32605	150 mm	100	50/1
P-31952	150 mm	120	10/1
P-32611	150 mm	120	50/1
P-31968	150 mm	150	10/1
P-31974	150 mm	180	10/1
P-32633	150 mm	180	50/1
P-31980	150 mm	220	10/1
P-31996	150 mm	240	10/1
P-32655	150 mm	240	50/1
P-32007	150 mm	320	10/1
P-32661	150 mm	320	50/1
P-32013	150 mm	400	10/1
P-32677	150 mm	400	50/1

## Vibracijski brusilniki

### Brusni papir

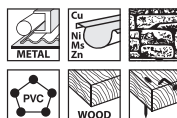

Koda	Dimenzija	Zrnatost	Enota (kos/set)
P-36398	140 × 114 mm	40	10/1
P-32904	140 × 114 mm	60	10/1
P-36441	140 × 114 mm	60	50/1
P-36407	140 × 114 mm	80	10/1
P-32910	140 × 114 mm	100	10/1
P-36463	140 × 114 mm	100	50/1
P-32926	140 × 114 mm	120	10/1
P-36479	140 × 114 mm	120	50/1
P-32932	140 × 114 mm	150	10/1
P-36485	140 × 114 mm	150	50/1
P-36413	140 × 114 mm	180	10/1
P-36429	140 × 114 mm	240	10/1

# Pribor za poliranje in brušenje

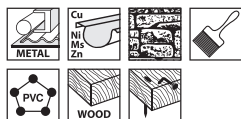

Koda	Dimenzija	Zrnatost	Enota (kos/set)
P-36516	140 × 114 mm	40	10/1
P-36522	140 × 114 mm	60	10/1
P-36603	140 × 114 mm	60	50/1
P-36538	140 × 114 mm	80	10/1
P-36619	140 × 114 mm	80	50/1
P-36544	140 × 114 mm	100	10/1
P-36625	140 × 114 mm	100	50/1
P-36550	140 × 114 mm	120	10/1
P-36566	140 × 114 mm	150	10/1
P-36647	140 × 114 mm	150	50/1
P-36572	140 × 114 mm	180	10/1
P-36588	140 × 114 mm	240	10/1
P-36669	140 × 114 mm	240	50/1

## Brusni papir - 6 lukenj

S pritrjevanjem na ježka.

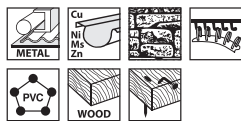

Koda	Dimenzija	Zrnatost	Enota (kos/set)
P-33087	102 × 114 mm	40	10/1
P-33093	102 × 114 mm	60	10/1
P-33102	102 × 114 mm	80	10/1
P-33118	102 × 114 mm	100	10/1
P-33124	102 × 114 mm	120	10/1
P-33130	102 × 114 mm	150	10/1
P-33146	102 × 114 mm	180	10/1
P-33152	102 × 114 mm	240	10/1
P-33168	102 × 114 mm	320	10/1

S pritrjevanjem na ježka.

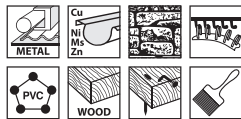

Koda	Dimenzija	Zrnatost	Enota (kos/set)
P-35807	102 × 114 mm	40	10/1
P-35813	102 × 114 mm	60	10/1
P-35829	102 × 114 mm	80	10/1
P-35835	102 × 114 mm	100	10/1
P-35841	102 × 114 mm	120	10/1
P-35857	102 × 114 mm	150	10/1
P-35863	102 × 114 mm	180	10/1
P-35879	102 × 114 mm	240	10/1
P-35885	102 × 114 mm	320	10/1

## Brusni papir

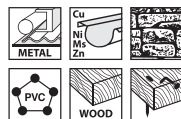

Koda	Dimenzija	Zrnatost	Enota (kos/set)
P-36136	230 × 93 mm	40	10/1
P-36186	230 × 93 mm	40	50/1
P-32948	230 × 93 mm	60	10/1
P-36192	230 × 93 mm	60	50/1
P-36142	230 × 93 mm	80	10/1
P-36201	230 × 93 mm	80	50/1
P-32954	230 × 93 mm	100	10/1
P-36217	230 × 93 mm	100	50/1
P-36158	230 × 93 mm	120	10/1
P-36223	230 × 93 mm	120	50/1
P-36239	230 × 93 mm	150	50/1
P-36245	230 × 93 mm	180	50/1
P-36170	230 × 93 mm	240	10/1
P-36251	230 × 93 mm	240	50/1

## Brusni papir - 8 lukenj

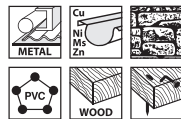

Koda	Dimenzija	Zrnatost	Enota (kos/set)
P-31837	230 × 93 mm	40	10/1
P-36055	230 × 93 mm	40	50/1
P-31843	230 × 93 mm	60	10/1
P-36061	230 × 93 mm	60	50/1
P-31859	230 × 93 mm	80	10/1
P-36077	230 × 93 mm	80	50/1
P-31865	230 × 93 mm	100	10/1
P-36083	230 × 93 mm	100	50/1
P-36011	230 × 93 mm	120	10/1
P-36099	230 × 93 mm	120	50/1
P-36027	230 × 93 mm	150	10/1
P-36108	230 × 93 mm	150	50/1
P-36033	230 × 93 mm	180	10/1
P-36114	230 × 93 mm	180	50/1
P-36049	230 × 93 mm	240	10/1
P-36120	230 × 93 mm	240	50/1

Akumulat orji in polnilniki  
 Pribor za akumulat orsko orodje  
 Akumulat orske svetilke in pribor  
 Pribor za lasarske merilnike  
 Pribor za rušenje in vrtanje  
 Pribor za vrtanje  
 Kronske žage  
 Pribor za vijačenje  
 Pribor za rezanje in brušenje  
 Pribor za poliranje in brušenje  
 Pribor za rezkanje in oblanje  
 Pribor za multifunkcijsko orodje  
 Pribor za žaganje  
 Pribor za žebjalnike in spenjalnike  
 Pribor za fene  
 Pribor za sesanje  
 Pribor za orodja za uporabo na prostem  
 Pribor za ročno orodje  
 Kovački in torbe za orodje  
 Ročno orodje  
 Razno  
 Pribor za mešanje

# Pribor za poliranje in brušenje

S pritrjevanjem na ježka.



Koda	Dimenzija	Zrnatost	Enota (kos/set)
P-31871	185 × 93 mm	40	10/1
P-35938	185 × 93 mm	40	50/1
P-31887	185 × 93 mm	60	10/1
P-35944	185 × 93 mm	60	50/1
P-31893	185 × 93 mm	80	10/1
P-31902	185 × 93 mm	100	10/1
P-35966	185 × 93 mm	100	50/1
P-35891	185 × 93 mm	120	10/1
P-35972	185 × 93 mm	120	50/1
P-35900	185 × 93 mm	150	10/1
P-35988	185 × 93 mm	150	50/1
P-35916	185 × 93 mm	180	10/1
P-35994	185 × 93 mm	180	50/1
P-35922	185 × 93 mm	240	10/1
P-36005	185 × 93 mm	240	50/1

## Brusni papir

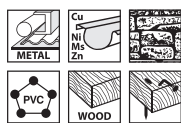

Koda	Dimenzija	Zrnatost	Enota (kos/set)
P-36267	280 × 115 mm	40	10/1
P-36310	280 × 115 mm	40	50/1
P-32976	280 × 115 mm	60	10/1
P-36326	280 × 115 mm	60	50/1
P-36273	280 × 115 mm	80	10/1
P-36332	280 × 115 mm	80	50/1
P-32982	280 × 115 mm	100	10/1
P-36348	280 × 115 mm	100	50/1
P-36289	280 × 115 mm	120	10/1
P-36354	280 × 115 mm	120	50/1
P-32998	280 × 115 mm	150	10/1
P-36360	280 × 115 mm	150	50/1
P-36295	280 × 115 mm	180	10/1
P-36376	280 × 115 mm	180	50/1
P-36304	280 × 115 mm	240	10/1
P-36382	280 × 115 mm	240	50/1

## Brusni papir - 14 lukenj

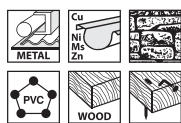

Koda	Dimenzija	Zrnatost	Enota (kos/set)
P-33009	280 × 115 mm	40	10/1
P-35645	280 × 115 mm	40	50/1

P-33015	280 × 115 mm	60	10/1
P-35651	280 × 115 mm	60	50/1
P-33021	280 × 115 mm	80	10/1
P-35667	280 × 115 mm	80	50/1
P-33037	280 × 115 mm	100	10/1
P-35673	280 × 115 mm	100	50/1
P-33043	280 × 115 mm	120	10/1
P-35689	280 × 115 mm	120	50/1
P-33059	280 × 115 mm	150	10/1
P-35695	280 × 115 mm	150	50/1
P-33065	280 × 115 mm	180	10/1
P-35704	280 × 115 mm	180	50/1
P-35710	280 × 115 mm	240	50/1

S pritrjevanjem na ježka.

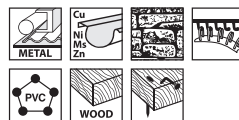

Koda	Dimenzija	Zrnatost	Enota (kos/set)
P-43022	229 × 115 mm	40	10/1
P-43103	229 × 115 mm	40	50/1
P-43038	229 × 115 mm	60	10/1
P-43119	229 × 115 mm	60	50/1
P-43044	229 × 115 mm	80	10/1
P-43125	229 × 115 mm	80	50/1
P-43050	229 × 115 mm	100	10/1
P-43131	229 × 115 mm	100	50/1
P-43066	229 × 115 mm	120	10/1
P-43147	229 × 115 mm	120	50/1
P-43072	229 × 115 mm	150	10/1
P-43153	229 × 115 mm	150	50/1
P-43169	229 × 115 mm	180	50/1
P-43094	229 × 115 mm	240	10/1
P-43175	229 × 115 mm	240	50/1

## Brusni papir - 10 lukenj

S pritrjevanjem na ježka.

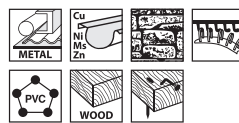

Koda	Dimenzija	Zrnatost	Enota (kos/set)
P-33174	229 × 115 mm	40	10/1
P-35726	229 × 115 mm	40	50/1
P-33180	229 × 115 mm	60	10/1
P-35732	229 × 115 mm	60	50/1
P-33196	229 × 115 mm	80	10/1
P-33205	229 × 115 mm	100	10/1
P-35754	229 × 115 mm	100	50/1
P-33211	229 × 115 mm	120	10/1
P-35760	229 × 115 mm	120	50/1
P-33227	229 × 115 mm	150	10/1
P-35776	229 × 115 mm	150	50/1
P-33233	229 × 115 mm	180	10/1
P-35782	229 × 115 mm	180	50/1
P-35798	229 × 115 mm	240	50/1

# Pribor za poliranje in brušenje

## Brusni papir delta - 6 lukenj

S pritrjevanjem na ježka.

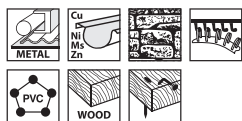

Koda	Dimenzija	Zrnatost	Enota (kos/set)
P-33255	94 × 94 × 94 mm	40	10/1
P-42597	94 × 94 × 94 mm	40	50/1
P-33261	94 × 94 × 94 mm	60	10/1
P-42606	94 × 94 × 94 mm	60	50/1
P-33277	94 × 94 × 94 mm	80	10/1
P-42612	94 × 94 × 94 mm	80	50/1
P-33283	94 × 94 × 94 mm	100	10/1
P-42628	94 × 94 × 94 mm	100	50/1
P-33299	94 × 94 × 94 mm	120	10/1
P-33308	94 × 94 × 94 mm	150	10/1
P-33314	94 × 94 × 94 mm	180	10/1
P-42656	94 × 94 × 94 mm	180	50/1
P-33320	94 × 94 × 94 mm	240	10/1
P-42662	94 × 94 × 94 mm	240	50/1
P-33336	94 × 94 × 94 mm	320	10/1
P-42678	94 × 94 × 94 mm	320	50/1

S pritrjevanjem na ježka.

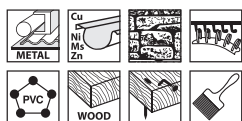

Koda	Dimenzija	Zrnatost	Enota (kos/set)
P-42684	94 × 94 × 94 mm	40	10/1
P-42771	94 × 94 × 94 mm	40	50/1
P-42690	94 × 94 × 94 mm	60	10/1
P-42787	94 × 94 × 94 mm	60	50/1
P-42709	94 × 94 × 94 mm	80	10/1
P-42793	94 × 94 × 94 mm	80	50/1
P-42715	94 × 94 × 94 mm	100	10/1
P-42802	94 × 94 × 94 mm	100	50/1
P-42721	94 × 94 × 94 mm	120	10/1
P-42818	94 × 94 × 94 mm	120	50/1
P-42737	94 × 94 × 94 mm	150	10/1
P-42824	94 × 94 × 94 mm	150	50/1
P-42743	94 × 94 × 94 mm	180	10/1
P-42830	94 × 94 × 94 mm	180	50/1
P-42759	94 × 94 × 94 mm	240	10/1
P-42846	94 × 94 × 94 mm	240	50/1
P-42765	94 × 94 × 94 mm	320	10/1
P-42852	94 × 94 × 94 mm	320	50/1

## Brusni papir v rolah

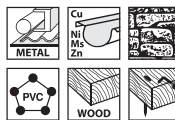

Koda	Širina	Dolžina	Zrnatost
P-38196	120 mm	50 m	40
P-38102	120 mm	5 m	40
P-38205	120 mm	50 m	60
P-38118	120 mm	5 m	60
P-38211	120 mm	50 m	80
P-38124	120 mm	5 m	80
P-38227	120 mm	50 m	100
P-38130	120 mm	5 m	100
P-38233	120 mm	50 m	120
P-38146	120 mm	5 m	120
P-38249	120 mm	50 m	180
P-38152	120 mm	5 m	180
P-38255	120 mm	50 m	240
P-38168	120 mm	5 m	240
P-38174	120 mm	5 m	320
P-38277	120 mm	50 m	400
P-38180	120 mm	5 m	400

## Vodoodporni brusni papir

Primerno za vse vibracijske brusilnike (suho brušenje) in ročno brušenje (suho/mokro brušenje).



Koda	Dimenzija	Zrnatost	Enota (kos/set)
D-58936	230 × 280 mm	60	50/1
D-58942	230 × 280 mm	80	50/1
D-58958	230 × 280 mm	100	50/1
D-58964	230 × 280 mm	120	50/1
D-58970	230 × 280 mm	150	50/1
D-58986	230 × 280 mm	180	50/1
D-58992	230 × 280 mm	220	50/1
D-59003	230 × 280 mm	280	50/1
D-59019	230 × 280 mm	320	50/1
D-59025	230 × 280 mm	400	50/1
D-59031	230 × 280 mm	600	50/1
D-59047	230 × 280 mm	800	50/1
D-59053	230 × 280 mm	1.000	50/1
D-56867	230 × 280 mm	1.200	50/1
D-59069	230 × 280 mm	1.500	50/1
D-59075	230 × 280 mm	2.000	50/1

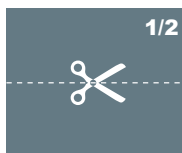

BO4900

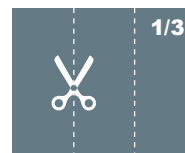

BO3710

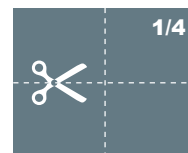

BO4555

Akumulat orji in polnilniki  
 Pribor za akumulat orsko orodje  
 Akumulat orske svetilke in pribor  
 Pribor za lasarske merilnike  
 Pribor za rušenje in vrtanje  
 Pribor za vrtanje  
 Pribor za vrtanje  
 Kronske žage  
 Pribor za vijčenje  
 Pribor za rezanje in brušenje  
 Pribor za poliranje in brušenje  
 Pribor za rezkanje in oblanje  
 Pribor za multifunkcijsko orodje  
 Pribor za žaganje  
 Pribor za žaganje  
 Pribor za žebjalnike in spenjalnike  
 Pribor za fene  
 Pribor za sesanje  
 Pribor za uporabo na prostem  
 Pribor za nosilne orodja za zaščito optima  
 Kovčki in torbe za orodje  
 Ročno orodje  
 Razno  
 Pribor za mešanje

## Ostali pribor za brusilnike

### Plošče za tračne brusilnike



Koda	Naziv	Za model
421093-8	Plutovinasta plošča	9401, 9402
421646-3	Plutovinasta plošča	9403
423035-8	Plutovinasta plošča	9924DB
423312-8	Plutovinasta plošča	9903
423313-6	Plutovinasta plošča	9920
423314-4	Plutovinasta plošča	9404
421648-9	Grafitna plošča	9403
423036-6	Grafitna plošča	9924DB
423315-2	Grafitna plošča	9903
423316-0	Grafitna plošča	9920
423317-8	Grafitna plošča	9404
A-86262	Grafitna plošča	9401, 9402
150980-1	Jeklena plošča in plošča iz plute 2/1	9403
151750-1	Jeklena plošča in plošča iz plute 2/1	9920
151751-9	Jeklena plošča in plošča iz plute 2/1	9403
151749-6	Jeklena plošča	9903
341705-6	Jeklena plošča	9924DB
345503-0	Jeklena plošča	9910, 9911

### Ostali pribor



Koda	Naziv	Za model
125157-7	Vodilna roka 6 mm	9032, DBS180
125158-5	Vodilna roka 9 mm	9032, DBS180
125159-3	Vodilna roka 13 mm	9032, DBS180
191N60-8	Zaščitni protiprašni pokrov	DBS180
193618-5	Vodilna peta	9032, DBS180
342152-4	Drsna zaščita	9030, 9031

### Luknjači



Koda	Dimenzija	Za model
163292-3	185 × 93 mm	9036
192523-3	280 × 115 mm	BO4900V, 9046
192989-7	185 × 93 mm	BO3700, BO3710, BO3711
450066-4	102 × 114 mm	BO4555, BO4556, BO4557

### Stojala za tračne brusilnike



Koda	Za model
193055-3	9404, 9903, 9902, 9920
STEX122299	9924DB

### Okvirji za tračne brusilnike



Koda	Za model
193070-7	9903, 9902
193072-3	9404

### Plošča - ježek



Koda	Dimenzija	Za model
194930-6	185 × 93 mm	BO3700, BO3710, BO3711

### Sponki za brusilnike



Koda	Za model	Enota (kos/set)
192694-6	9910, 9911	2/1



# ROTOREZKARJI IZ VOLFRAMOVEGA KARBIDA

## VRSTA REZA IN UPORABA

### Standardni rez

Prednost: visoka učinkovitost  
Površina: groba  
Material: kovine, nerjaveče jeklo

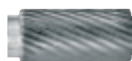

### Diamantni rez

Prednost: manj vibracij  
Površina: gladka  
Material: kovine, nerjaveče jeklo



### Rez za barvne kovine

Prednost: manj zamaševanja  
Površina: groba  
Material: barvne kovine, plastika



## PRIMERNO ZA

### Materiali:

Jeklo, lito železo, nerjaveče jeklo, nikelj-kobalt, barvne kovine, aluminij itd.



## OBLIKA GLAVE IN UPORABA

Oblika: A

Oblika: C

Oblika: F

Oblika: L

Oblika: M

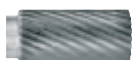

Za odstranjevanje srhov na inox-u



Za odstranjevanje srhov na aluminiju



Za brušenje varilnega šiva med jeklenima ploščama



	Koda	Enota (kos/set)	Oblika glave	Vrsta reza	Dimenzija	Vpetje	Primerno za
	B-52716-10	10/1	A	standardni rez	10x20 mm	6 mm	kovine, nerjavno jeklo
	B-52716	1					
	B-52722-10	10/1	A	diamantni rez	10x20 mm	6 mm	kovine, nerjavno jeklo
	B-52722	1					
	B-52738-10	10/1	A	rez za barvne kovine	10x20 mm	6 mm	barvne kovine
	B-52738	1					
	B-52744-10	10/1	C	standardni rez	10x20 mm	6 mm	kovine, nerjavno jeklo
	B-52744	1					
	B-52750-10	10/1	C	diamantni rez	10x20 mm	6 mm	kovine, nerjavno jeklo
	B-52750	1					
	B-52766-10	10/1	C	rez za barvne kovine	10x20 mm	6 mm	barvne kovine
	B-52766	1					
	B-52772-10	10/1	F	standardni rez	10x20 mm	6 mm	kovine, nerjavno jeklo
	B-52772	1					
	B-52788-10	10/1	F	diamantni rez	10x20 mm	6 mm	kovine, nerjavno jeklo
	B-52788	1					
	B-52794-10	10/1	F	rez za barvne kovine	10x20 mm	6 mm	barvne kovine
	B-52794	1					
	B-52803-10	10/1	L	standardni rez	10x25 mm	6 mm	kovine, nerjavno jeklo
	B-52803	1					
	B-52819-10	10/1	L	diamantni rez	10x25 mm	6 mm	kovine, nerjavno jeklo
	B-52819	1					
	B-52825-10	10/1	L	rez za barvne kovine	10x25 mm	6 mm	barvne kovine
	B-52825	1					
	B-52831-10	10/1	M	standardni rez	10x20 mm	6 mm	kovine, nerjavno jeklo
	B-52831	1					
	B-52847-10	10/1	M	diamantni rez	10x20 mm	6 mm	kovine, nerjavno jeklo
	B-52847	1					
	B-52853-10	10/1	M	rez za barvne kovine	10x20 mm	6 mm	barvne kovine
	B-52853	1					

## Premi brusilniki

### Brusilne pahljače

Natančna obdelava različnih materialov. Brusilne pahljače omogočajo obdelavo površin z vrtalniki (10-16 mm) in s premimi brusilniki z nastavljivim številom vrtljajev. Zaradi strukture omogočajo natančna brusilna dela na materialih različnih dimenzij in oblik, kot so cevi, pravokotne in zavite površine.

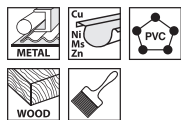

Koda	Premer	Širina	Največje število obratov	Zrnatost
B-36865	50,8 mm	25,4 mm	15.300 min <sup>-1</sup>	40
B-36918	50,8 mm	38,1 mm	15.300 min <sup>-1</sup>	40
B-36968	50,8 mm	50,8 mm	15.300 min <sup>-1</sup>	40
B-37013	63,5 mm	25,4 mm	12.700 min <sup>-1</sup>	40
B-37063	76 mm	25,4 mm	10.000 min <sup>-1</sup>	40
B-37116	76 mm	50,8 mm	10.000 min <sup>-1</sup>	40
B-36871	50,5 mm	25,4 mm	15.300 min <sup>-1</sup>	60
B-36924	50,8 mm	38,1 mm	15.300 min <sup>-1</sup>	60
B-36974	50,8 mm	50,8 mm	15.300 min <sup>-1</sup>	60
B-37029	63,5 mm	25,4 mm	12.700 min <sup>-1</sup>	60
B-37079	76 mm	25,4 mm	10.000 min <sup>-1</sup>	60
B-37122	76 mm	50,8 mm	10.000 min <sup>-1</sup>	60
B-36887	50,5 mm	25,4 mm	15.300 min <sup>-1</sup>	80
B-36930	50,8 mm	38,1 mm	15.300 min <sup>-1</sup>	80
B-36980	50,8 mm	50,8 mm	15.300 min <sup>-1</sup>	80
B-37035	63,5 mm	25,4 mm	12.700 min <sup>-1</sup>	80
B-37085	76 mm	25,4 mm	10.000 min <sup>-1</sup>	80
B-37138	76 mm	50,8 mm	10.000 min <sup>-1</sup>	80
B-36893	50,8 mm	25,4 mm	15.300 min <sup>-1</sup>	120
B-36946	50,8 mm	38,1 mm	15.300 min <sup>-1</sup>	120
B-36996	50,8 mm	50,8 mm	15.300 min <sup>-1</sup>	120
B-37041	63,5 mm	25,4 mm	12.700 min <sup>-1</sup>	120
B-37091	76 mm	25,4 mm	10.000 min <sup>-1</sup>	120
B-37144	76 mm	50,8 mm	10.000 min <sup>-1</sup>	120
B-36902	50,8 mm	25,4 mm	15.300 min <sup>-1</sup>	180
B-36952	50,8 mm	38,1 mm	15.300 min <sup>-1</sup>	180
B-37007	50,8 mm	50,8 mm	15.300 min <sup>-1</sup>	180
B-37057	63,5 mm	25,4 mm	12.700 min <sup>-1</sup>	180
B-37100	76 mm	25,4 mm	10.000 min <sup>-1</sup>	180
B-37150	76 mm	50,8 mm	10.000 min <sup>-1</sup>	180

### Vpenjalne puše in matice



Vpenjalna puša	Vpenjalna matica	Premer	Za model
763627-4		3 mm	
763620-8	763606-2	6 mm	906
763627-4		3 mm	
763620-8	763664-8	6 mm	GD0601
763627-4		3 mm	
763620-8	763236-9	6 mm	GD0603

763669-8		3 mm	
763670-3	763668-0	6 mm	GD0602, BGD800, DGD800
763671-1		8 mm	

Vpenjalna puša z vpenjalno matico	Vpenjalna matica	Premer	Za model
193011-3		3 mm	
193012-1	763645-2	6 mm	GD0800C, GD0810C
192988-9		8 mm	

## Dvojni brusilniki

### Brusilne plošče za kovine



Koda	Tip plošče	Premer plošče	Premer luknje	Debelina plošče
B-51895	A60	150 mm	12,7 mm	6,4 mm
B-51904	A36M	150 mm	12,7 mm	16 mm
B-51910	A60M	150 mm	12,7 mm	16 mm
B-51926	WA60K	150 mm	12,7 mm	16 mm
B-51948	A36P	205 mm	15,88 mm	19 mm
B-51954	A60P	205 mm	15,88 mm	19 mm
B-51960	WA60K	205 mm	15,88 mm	19 mm

### Brusilne plošče za barvne kovine



Koda	Tip plošče	Premer plošče	Premer luknje	Debelina plošče
B-51932	GC120H	150 mm	12,7 mm	16 mm
B-51976	GC120H	205 mm	15,88 mm	19 mm

# Pribor za poliranje in brušenje



## Polirniki / brusilniki

### Brusni papir za GV6010

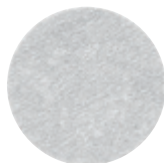

Koda	Premer	Zrnatost	Enota (kos/set)
794274-0	150 mm	WA60	10/1
794275-8	150 mm	WA100	10/1
794276-6	150 mm	WA120	10/1
794277-4	150 mm	WA150	10/1
794278-2	150 mm	WA180	10/1

### Brusni papir

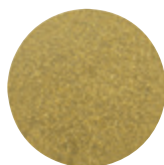

Koda	Premer	Zrnatost	Enota (kos/set)
P-33439	180 mm	40	10/1
P-38037	180 mm	60	10/1
P-33445	180 mm	80	10/1
P-38043	180 mm	100	10/1
P-33451	180 mm	120	10/1
P-38059	180 mm	240	10/1
P-38065	180 mm	320	10/1
P-38071	180 mm	360	10/1
P-38087	180 mm	400	10/1
P-38093	180 mm	500	10/1

### Volnene polirne prevleke



Koda	Premer	Pritrjevanje na ježka	Primerno za
197897-7	125 mm		Poliranje do visokega leska
D-70867	125 mm		Poliranje do visokega leska
794560-9	140 mm	Da	Poliranje do visokega leska
D-65735	150 mm		Poliranje do visokega leska
199424-6	150 mm	Da	Poliranje do visokega leska
192629-7	180 mm	Da	Poliranje lesa
794176-0	180 mm		Poliranje lesa

### Obojestranske volnene polirne prevleke



Koda	Premer	Pritrjevanje na ježka	Primerno za
D-56954	230 mm		Groba zaključna dela
D-56960	/		Adapter za D-56954

- Akumulat orji in polirniki
- Pribor za akumulat orsko orodje
- Akumulat orske svetilke in pribor
- Pribor za lasarske mernilnike
- Pribor za rušenje in vrtanje
- Pribor za vrtanje
- Kronske žage
- Pribor za vijčenje
- Pribor za rezanje in brušenje
- Pribor za poliranje in brušenje
- Pribor za rezkanje in oblanje
- Pribor za multitank ciljsko orodje
- Pribor za zaganje
- Pribor za žebjalnike in spenjalnike
- Pribor za fene
- Pribor za sesanje
- Pribor orodja za uporabo na prostem
- Pribor za ročno orodje
- Kovčki in torbe za orodje
- Ročno orodje
- Razno
- Pribor za mešanje

## Penaste polirne plošče



Koda	Premer	Pritrjevanje na ježka	Primerno za
794558-6	125 mm		Nanašanje voska
197894-3	150 mm		Nanašanje voska
P-21727	150 mm	Da	Obdelavo večplastnih nanosov barv
P-21733	150 mm	Da	Obdelavo celuloze in akrilnih snovi
P-21749	150 mm	Da	Poliranje in mešanje

## Klobučevinaste polirne plošče



Koda	Premer	Pritrjevanje na ježka	Primerno za
196152-4	125 mm	Da	Odstranjevanje voska
794618-4	150 mm	Da	Odstranjevanje voska

## Podporni krožniki za polirnike / brusilnike

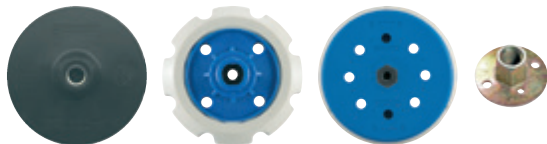

Koda	Premer	Pritrjevanje na ježka	Opis	Za model
P-21777	120 mm	Da	Za penaste polirne plošče	9237CB, PV7000C, SA5040C
743081-8	123 mm	Da	Za brušenje	BO5030, BO5031, BO5041, M2904, DB0180
743060-6	125 mm	Da	Podporni krožnik	SA5040C, 9565CVR
197922-4	125 mm	Da	Gumijast, trd	DPO600, PO6000C
197928-2	150 mm	Da	Gumijast, trd	DPO600, PO6000C
197317-1	130 mm	Da	Za poliranje - gumijast, trd	BO6050
197315-5	150 mm	Da	Za grobo brušenje - gumijast, trd	BO6050
197314-7	150 mm	Da	Za brušenje - gumijast, mehek	BO6050
197316-3	150 mm	Da	Za fino brušenje - gumijast, izjemno mehek	BO6050
196685-9	150 mm	Da	Za grobo brušenje - gumijast, trd	BO6030, BO6040
196684-1	150 mm	Da	Za brušenje - gumijast, mehek	BO6030, BO6040
196686-7	150 mm	Da	Za fino brušenje - gumijast, izjemno mehek	BO6030, BO6040
743053-3	165 mm	Da	Za polirne prevleke za 180 mm polirnike	PV7000C, 9237CB, SA7000C
P-21761	170 mm	/	Za polirne prevleke za 225 mm polirnike	PV7000C
224515-5	M14 x 2 (DIN)	/	Zatezna matica	9207SPB, 98237CB, SA7000C, SA5040C, PV7000C

## Kotni brusilniki

### Brusni papir - aluminijev oksid

Abrazivni brusilni list je sestavljen iz vlaken in smole ter ima sredico iz aluminijevega oksida, nosilnost pa je dosežena z uporabo steklenih vlaken. Primerni za uporabo s podpornimi gumijastimi krožniki. Uporaba: odstranjevanje rje in čiščenje kovinskih površin, odstranjevanje barve in lakov, obdelava in izravnavanje zvarov in brušenje robov, posnemanje robov in brušenje posod in drugih naprav.

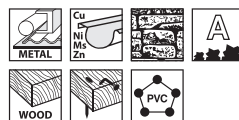

Koda	Premer	Zrnatost	Enota (kos/set)
P-00854	115/22,23 mm	16	5/1
P-00860	115/22,23 mm	24	5/1
P-00876	115/22,23 mm	36	5/1
P-00882	115/22,23 mm	40	5/1
P-00898	115/22,23 mm	50	5/1
P-00907	115/22,23 mm	60	5/1
P-00913	115/22,23 mm	80	5/1
P-00929	115/22,23 mm	100	5/1
P-00935	115/22,23 mm	120	5/1
P-00957	125/22,23 mm	24	5/1
P-00963	125/22,23 mm	36	5/1
P-00979	125/22,23 mm	40	5/1
P-00985	125/22,23 mm	60	5/1
P-00991	125/22,23 mm	80	5/1
P-01002	125/22,23 mm	100	5/1
P-01018	125/22,23 mm	120	5/1
P-01024	180/22,23 mm	16	5/1
P-01030	180/22,23 mm	24	5/1
P-01052	180/22,23 mm	40	5/1
P-01068	180/22,23 mm	50	5/1
P-01074	180/22,23 mm	60	5/1
P-01080	180/22,23 mm	80	5/1
P-01096	180/22,23 mm	100	5/1
P-01105	180/22,23 mm	120	5/1

### Podporni gumijasti krožniki za kotne brusilnike



Koda	Premer	Vpetje
P-05882	115 mm	M14
P-05898	125 mm	M14
P-05913	180 mm	M14



## Krtačni brusilnik 9741

### Najlonske krtače

Za grobo obdelavo mehkega lesa, končno obdelavo trdega lesa, poudarjeno leseno strukturo in odstranjevanje lesenih vlaken. Po obdelavi je površina primerna za barvanje in lakiranje. Poleg tega so primerne za fino obdelavo nerjavnega jekla ali aluminija.

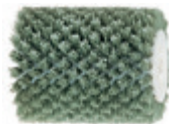

Koda	Premer	Širina	Zrnatost
P-04422	100 mm	120 mm	60
794384-3	100 mm	120 mm	80
P-04438	100 mm	120 mm	80
P-04444	100 mm	120 mm	120
P-04450	100 mm	120 mm	180

### Krtače iz klobučevine

Za natančno obdelavo nerjavnega jekla in fino brušenje lesenih površin.



Koda	Premer	Širina	Zrnatost
P-18035	100 mm	120 mm	80
P-18041	100 mm	120 mm	120
P-18029	100 mm	120 mm	180

### Krtače iz klobučevine in lana

Za natančno obdelavo nerjavnega jekla in fino brušenje lesenih površin.



Koda	Premer	Širina	Zrnatost
P-18057	100 mm	120 mm	80
P-19233	100 mm	120 mm	120
P-19249	100 mm	120 mm	180

### Brusilne krtače

Za odstranjevanje barv in končno obdelavo.

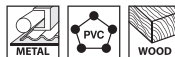

Koda	Premer	Širina	Zrnatost
P-01127	100 mm	120 mm	40
P-01155	100 mm	120 mm	80



Koda	Premer	Širina	Zrnatost
P-04416	100 mm	120 mm	/

### Bombažne krtače

Za poliranje kovinskih površin.



Koda	Premer	Širina	Zrnatost
794381-9	100 mm	120 mm	/

### Žične krtače

Za čiščenje rje in betona.

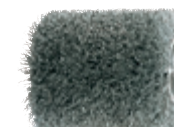

Koda	Premer	Širina	Debelina žice
P-04400	100 mm	120 mm	0,3 mm

### Medeninaste žične krtače

Za obdelavo lesa, čiščenje in odstranjevanje rje.



Koda	Premer	Širina	Debelina žice
P-65648	100 mm	120 mm	0,3 mm

Akumulat  
ori in  
poinliniki

Pribor za  
akumulat  
orsko  
orodje

Akumulat  
orske  
svetilke  
in pribor

Pribor za  
lasarske  
merilnike

Pribor za  
rušenje  
in vrtanje

Pribor za  
vrtanje

Kronske  
žage

Pribor za  
vijačenje

Pribor za  
rezanje  
in  
brušenje

Pribor za  
poliranje  
in  
brušenje

Pribor za  
rezanje  
in  
oblanje

Pribor za  
multifunk  
cjsko  
orodje

Pribor za  
žaganje

Pribor za  
žebjalnike  
in  
spenjalnike

Pribor za  
fene

Pribor za  
sesanje

Pribor  
orodja za  
uporabo  
na prostem

Pribor za  
nosilne  
orodja in  
zaščitna  
oprema

Kovčki in  
torbe za  
orodje

Ročno  
orodje

Razno

Pribor za  
mešanje



# PRIBOR ZA REZKANJE IN OBLANJE

Aluminij



Les



## Standardna rezkala

### Rezkala za utore z enim rezilom

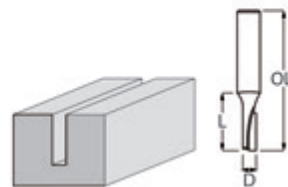

Koda	Dolžina (OL) (mm)	Širina (D) (mm)	Delovna dolžina (L) (mm)	Vpetje	Število rezil	Največje število obratov (min <sup>-1</sup> )	Cena z DDV
D-47379	51	3	13	8 mm	1	28.000	
D-47385	51	4	13	8 mm	1	28.000	
D-47391	48	5	13	8 mm	1	28.000	
D-47400	50,8	6	19	8 mm	1	28.000	
D-47416	50,8	6	19	6 mm	1	28.000	

### Rezkala za utore z dvema reziloma

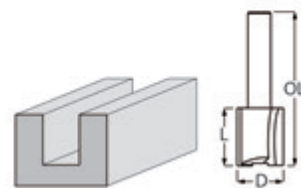

Koda	Dolžina (OL) (mm)	Širina (D) (mm)	Delovna dolžina (L) (mm)	Vpetje	Število rezil	Največje število obratov (min <sup>-1</sup> )	Cena z DDV
D-47444	51	8	19	6 mm	2	28.000	
D-47466	25,4	10	57,4	6 mm	2	24.000	
D-47503	48	6	16	8 mm	2	28.000	
D-47525	51	8	19	8 mm	2	28.000	
D-47531	51	10	19	8 mm	2	28.000	
D-47547	51	12	19	8 mm	2	28.000	
D-47569	55,7	16	19	8 mm	2	24.000	
D-47684	73	25	32	12 mm	2	18.000	

### Poravnalna rezkala z dvema reziloma

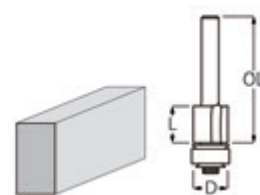

Koda	Dolžina (OL) (mm)	Širina (D) (mm)	Delovna dolžina (L) (mm)	Vpetje	Število rezil	Največje število obratov (min <sup>-1</sup> )	Premer krogličnega ležaja (H) (mm)	Cena z DDV
D-47709	56	12,7	13	6 mm	2	28.000	12,7	
D-47721	67	9,5	26	8 mm	2	24.000	9,5	
D-47737	55,7	12,7	13	8 mm	2	28.000	12,7	

[Nadaljevanje...](#)

Akumulat orji in polnilniki  
 Pribor za akumulat orsko orodje  
 Akumulat orske svetilke in pribor  
 Pribor za laserske merilnike  
 Pribor za rušenje in vrtanje  
 Pribor za vrtanje  
 Kronske žage  
 Pribor za vijačenje  
 Pribor za rezanje in brušenje  
 Pribor za poliranje in brušenje  
 Pribor za rezkanje in oblanje  
 Pribor za multitfunkcijsko orodje  
 Pribor za žaganje  
 Pribor za žabljanske spenjalnike  
 Pribor za fene  
 Pribor za sesanje  
 Pribor orodja za uporabo na prostem  
 Pribor za nožne orodja in zaščitna oprema  
 Kovčki in torbe za orodje  
 Ročno orodje  
 Razno  
 Pribor za mešanje

# Pribor za rezkanje in oblanje

Koda	Dolžina (OL) (mm)	Širina (D) (mm)	Delovna dolžina (L) (mm)	Vpetje	Število rezil	Največje število obratov (min <sup>-1</sup> )	Premer krogličnega ležaja (H) (mm)	Cena z DDV
D-47743	68,5	12,7	26	8 mm	2	24.000	12,7	

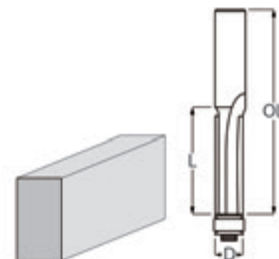

## Poravnalna rezkala s tremi rezili

Koda	Dolžina (OL) (mm)	Širina (D) (mm)	Delovna dolžina (L) (mm)	Vpetje	Število rezil	Največje število obratov (min <sup>-1</sup> )	Premer krogličnega ležaja (H) (mm)	Cena z DDV
D-47765	91,4	12,7	38	12 mm	3	24.000	9,5	

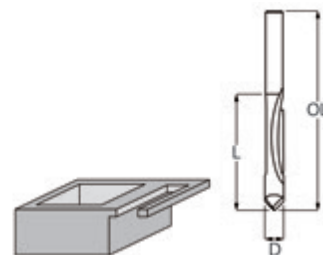

## Rezkala za stransko rezkanje

Koda	Dolžina (OL) (mm)	Širina (D) (mm)	Delovna dolžina (L) (mm)	Vpetje	Število rezil	Največje število obratov (min <sup>-1</sup> )	Cena z DDV
D-47771	65	6,35	19	6 mm	1	28.000	
D-47787	65	6,35	19	8 mm	1	28.000	
D-47793	75	9,5	26	12 mm	1	24.000	

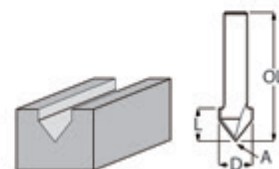

## Rezkala za V-utore

Koda	Dolžina (OL) (mm)	Širina (D) (mm)	Delovna dolžina (L) (mm)	Kot (A) (°)	Vpetje	Število rezil	Največje število obratov (min <sup>-1</sup> )	Cena z DDV
D-47896	44,7	12,7	12,7	90	8 mm	2	28.000	
D-47927	50,8	15,9	12,7	90	12 mm	2	24.000	
D-47955	60,3	28,6	22,2	90	12 mm	2	18.000	
D-68220	47,6	19	16	90	8 mm	2	24.000	

## Rezkala za U-utore

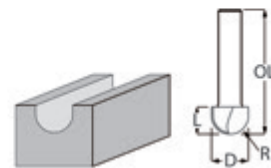

Koda	Dolžina (OL) (mm)	Širina (D) (mm)	Delovna dolžina (L) (mm)	Radij (R) (mm)	Vpetje	Število rezil	Največje število obratov (min <sup>-1</sup> )	Cena z DDV
D-48000	41,5	12,7	10	6,35	8 mm	2	28.000	
D-48016	44,5	15,8	12,7	7,9	8 mm	2	24.000	

## Rezkala za rogličenje

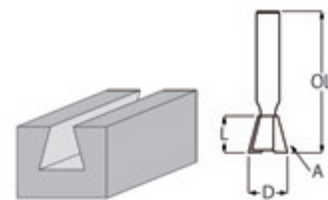

Koda	Dolžina (OL) (mm)	Širina (D) (mm)	Delovna dolžina (L) (mm)	Kot (A) (°)	Vpetje	Število rezil	Največje število obratov (min <sup>-1</sup> )	Cena z DDV
D-48072	45	12,7	13	14	8 mm	2	28.000	
D-48103	64	25,4	22,2	14	12 mm	2	18.000	

## Zaobljena rezkala z ležajem

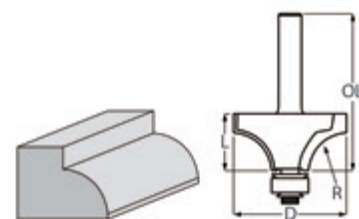

Koda	Dolžina (OL) (mm)	Širina (D) (mm)	Delovna dolžina (L) (mm)	Radij (R) (mm)	Vpetje	Število rezil	Največje število obratov (min <sup>-1</sup> )	Premer krogličnega ležaja (H) (mm)	Cena z DDV
D-48343	51	17,3	8	2,3	8 mm	2	24.000	12,7	
D-48359	53,4	19	9,5	3,2	8 mm	2	24.000	12,7	
D-48387	56,5	25,4	13,5	6,35	8 mm	2	18.000	12,7	
D-48393	57,3	28,6	14,5	7,9	8 mm	2	18.000	12,7	
D-48402	59,7	31,8	16,7	9,5	8 mm	2	18.000	12,7	
D-48418	62	38,1	19	12,7	8 mm	2	16.000	12,7	
D-48424	76,2	50,8	25,4	19	12 mm	2	14.000	12,7	

- Akumulat orji in polnilniki
- Pribor za akumulat orsko orodje
- Akumulat orske svetilke in pribor
- Pribor za lasarske mehanike
- Pribor za rušenje in vrtanje
- Pribor za vrtanje
- Kronske žage
- Pribor za vijachenje
- Pribor za rezanje in brušenje
- Pribor za poliranje in brušenje
- Pribor za rezkanje in oblanje
- Pribor za multitfunkcijsko orodje
- Pribor za žaganje
- Pribor za žebjalnike in spenjalnike
- Pribor za fene
- Pribor za sesanje
- Pribor za uporabo na prostem
- Pribor za varnostna oprema
- Kovčki in torbe za orodje
- Ročno orodje
- Razno
- Pribor za mešanje

# Pribor za rezkanje in oblanje

Akumulat  
orji in  
povlečni  
akumulat  
orske  
svetilke  
in pribor  
Pribor za  
lasarske  
mrežnice  
Pribor za  
rušenje  
in vrtanje  
Pribor za  
vrtnje  
Kronske  
žage  
Pribor za  
vijačenje  
Pribor za  
rezanje  
in  
brušenje  
Pribor za  
poliranje  
in  
brušenje  
Pribor za  
rezkanje  
in  
oblanje  
Pribor za  
multitank  
cjsko  
orodje  
Pribor za  
žaganje  
Pribor za  
žebjanike  
in  
spenjalnike  
Pribor za  
fene  
Pribor za  
sesanje  
Pribor  
orodja za  
uporabo  
na prostem  
Pribor za  
rošanje  
in  
zaščitna  
oprema  
Kovčki in  
torbe za  
orodje  
Ročno  
orodje  
Razno  
Pribor za  
mešanje

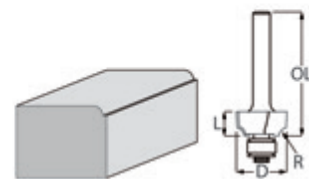

## Zaobljena profilna rezkala z ležajem

Koda	Dolžina (OL) (mm)	Širina (D) (mm)	Delovna dolžina (L) (mm)	Radij (R) (mm)	Vpetje	Število rezil	Največje število obratov (min <sup>-1</sup> )	Premer krogličnega ležaja (H) (mm)	Cena z DDV
D-48430	49,1	17	8	2,3	6 mm	2	24.000	9,5	
D-48446	51,6	19	9,5	3,2	6 mm	2	24.000	9,5	
D-48527	54,7	25,4	13,5	6,35	8 mm	2	18.000	9,5	
D-48549	57,9	31,8	17	9,5	8 mm	2	18.000	9,5	
D-48555	60,2	38,1	19	12,7	8 mm	2	16.000	9,5	
D-48561	74,5	50,8	25,4	19	12 mm	2	14.000	9,5	

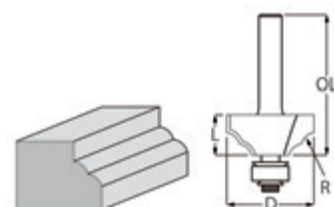

## Rezkala za obdelavo dvojnih robov

Koda	Dolžina (OL) (mm)	Širina (D) (mm)	Delovna dolžina (L) (mm)	Radij (R) (mm)	Vpetje	Število rezil	Največje število obratov (min <sup>-1</sup> )	Premer krogličnega ležaja (H) (mm)	Cena z DDV
D-48577	50,8	28,6	12,7	4	8 mm	2	18.000	12,7	

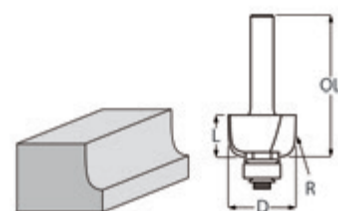

## Rezkala za izdelavo žlebov z ležajem

Koda	Dolžina (OL) (mm)	Širina (D) (mm)	Delovna dolžina (L) (mm)	Radij (R) (mm)	Vpetje	Število rezil	Največje število obratov (min <sup>-1</sup> )	Premer krogličnega ležaja (H) (mm)	Cena z DDV
D-48614	55,6	22,2	12,7	4,8	8 mm	2	24.000	12,7	
D-48620	55,5	28,6	12,7	7,9	8 mm	2	18.000	12,7	
D-48636	56	31,8	14	9,5	8 mm	2	18.000	12,7	



## Rezkala za posnemanje robov z ležajem

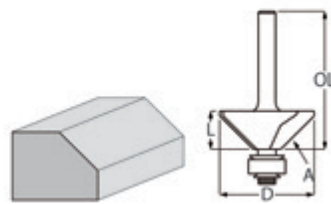

Koda	Dolžina (OL) (mm)	Širina (D) (mm)	Delovna dolžina (L) (mm)	Kot (A) (°)	Vpetje	Število rezil	Največje število obratov (min <sup>-1</sup> )	Premer krogličnega ležaja (H) (mm)	Cena z DDV
D-48658	51	25,4	11	45	6 mm	2	18.000	12,7	
D-48686	55,1	31,8	13,5	45	8 mm	2	18.000	12,7	
D-48692	58,8	34,9	16	45	8 mm	2	16.000	12,7	
D-48701	58,9	41,3	20	45	8 mm	2	16.000	12,7	
D-48723	70,9	50,8	27	45	12 mm	2	14.000	12,7	

## Rezkala za izdelovanje profilov z ležajem

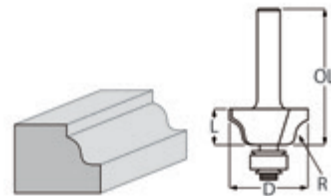

Koda	Dolžina (OL) (mm)	Širina (D) (mm)	Delovna dolžina (L) (mm)	Radij (R) (mm)	Vpetje	Število rezil	Največje število obratov (min <sup>-1</sup> )	Premer krogličnega ležaja (H) (mm)	Cena z DDV
D-48751	55,3	28,6	13	4	8 mm	2	18.000	12,7	
D-48810	55,3	28,6	13	4	6 mm	2	18.000	12,7	

## Profilna rezkala za izdelavo žlebov z ležajem

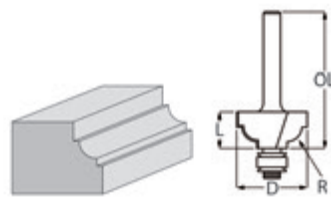

Koda	Dolžina (OL) (mm)	Širina (D) (mm)	Delovna dolžina (L) (mm)	Radij (R) (mm)	Vpetje	Število rezil	Največje število obratov (min <sup>-1</sup> )	Premer krogličnega ležaja (H) (mm)	Cena z DDV
D-48795	53,7	25,4	12,7	4,8	6 mm	2	18.000	12,7	

Akumulat  
orji in  
povlečke

Pribor za  
akumulat  
orsko  
orodje

Akumulat  
orske  
svetilke  
in pribor

Pribor za  
lasarske  
merilnike

Pribor za  
rušenje  
in vrtanje

Pribor za  
vrtanje

Kronske  
žage

Pribor za  
vijačenje

Pribor za  
rezanje  
in  
brušenje

Pribor za  
poliranje  
in  
brušenje

Pribor za  
rezkanje  
in  
oblanje

Pribor za  
multifunk  
ciljsko  
orodje

Pribor za  
žaganje

Pribor za  
žebjalnike  
in  
spenjalnike

Pribor za  
fene

Pribor za  
sesanje

Pribor  
orodja za  
uporabo  
na prostem

Pribor za  
hidro  
orodja in  
zaščitna  
oprema

Kovčki in  
torbe za  
orodje

Ročno  
orodje





Razno

Pribor za  
mešanje

## Seti





## Seti rezkal



	Koda	Naziv	Vpetje	Cena z DDV
	A-87921	12-delni set za rezkanje	6 mm	
	D-53534	4-delni set rezkal	8 mm	
	D-53540	6-delni set rezkal	8 mm	
	D-53556	12-delni set rezkal	8 mm	

## Pribor za rezkanje

## Vpenjalne puše, matice in rezkarji

	Koda	Naziv	Premer (Ø) (mm)	Za model	Enota (kos/set)	Cena z DDV
	763601-2	Vpenjalna puša in matica	12	3600B	2/1	
	763615-1	Vpenjalna matica	/	3608B	1	
	763629-0	Vpenjalna matica	/	3612, 3612C, M3600, M3602, MT362	1	
	763622-4	Vpenjalna puša	12,7	3612, 3612C, RP1800,0RP1801, RP2300, RP2301	1	
	763803-0	Vpenjalna puša	6,35	3612BR	1	

[Nadaljevanje...](#)





# Pribor za rezkanje in oblanje

Koda	Naziv	Premer (Ø) (mm)	Za model	Enota (kos/set)	Cena z DDV	
763636-3	Vpenjalna puša	6	3620, RP0900, RT0700C	1		
763618-5	Vpenjalna puša	8	3620, RP0900, RT0700C, RT0702C	1		
324149-5	Vpenjalna puša	3,18	3706	1		
763608-8	Vpenjalna puša	6,35	3706	1		
763607-0	Vpenjalna puša	6	3706, 3708	1		
193483-2	Rezkar za les in plastiko	3,18	3706, DCO180	1		
733232-1	Rezkar za suhomontažne stene	6,35	3706, DCO180, DCO181	1		
733240-2	Rezkar za les in plastiko	3,18	3706, DCO180, DCO181	1		
763661-4	Vpenjalna matica	6	3709, 3710	1		
763662-2	Vpenjalna puša	6	3709, 3710	1		
763663-0	Vpenjalna puša	6,35	3709, 3710	1		
763675-3	Vpenjalna matica	/	DCO180	1		
763679-5	Vpenjalna puša	3	DCO180	1		
763676-1	Vpenjalna puša	6,35	DCO180, DCO181	1		
763677-9	Vpenjalna puša	3,18	DCO180, DCO181	1		
763678-7	Vpenjalna puša	6	DCO180, DCO181	1		

[Nadaljevanje...](#)

- Akumulat orji in polnilniki
- Pribor za akumulat orske orodje
- Akumulat orske svetilke in pribor
- Pribor za lasarske merilnike
- Pribor za rušenje in vrtanje
- Pribor za vrtanje
- Kronske žage
- Pribor za vijachenje
- Pribor za rezanje in brušenje
- Pribor za poliranje in brušenje
- Pribor za rezkanje in oblanje
- Pribor za multitank ciljsko orodje
- Pribor za zaganje
- Pribor za zebjalnike in spenjalnike
- Pribor za fene
- Pribor za sesanje
- Pribor orodja za uporabo na prostem
- Pribor za kroglo in orodja in zaščitna oprema
- Kovčki in torbe za orodje
- Ročno orodje
- Razno orodje
- Pribor za mešanje

# Pribor za rezkanje in oblanje

	Koda	Naziv	Premer (Ø) (mm)	Za model	Enota (kos/set)	Cena z DDV
Akumulat orji in polnilniki						
Pribor za akumulat orsko orodje		193178-7	Vpenjalna puša in matica	8	RP0910, RP1110C	2/1
Akumulat orske svetilke in pribor		193180-0	Vpenjalna puša in matica	6	RP0910, RP1110C	2/1
Pribor za laserske merilnike						
Pribor za rušenje in vrtanje		763674-5	Vpenjalna matica	/	RP1800	1
Pribor za vrtanje		763628-2	Vpenjalna puša	12	RP1800, RP1801, RP2300, RP2301FCX, 3612, 3612C, RP1803F, RP2303FC	1
Kronske žage						
Pribor za vijačenje		763801-4	Vpenjalna puša	6	RP1800, RP1801, RP2300, RP2301FCX, 3612, 3612C, RP1803F, RP2303FC	1
Pribor za rezanje in brušenje		763804-8	Vpenjalna puša	8	RP1800, RP1801, RP2300, RP2301FCX, 3612, 3612C, RP1803F, RP2303FC	1
Pribor za poliranje in brušenje						
Pribor za rezkanje in oblanje		763807-2	Vpenjalna puša	10	RP1800, RP1801, RP2300, RP2301FCX, 3612, 3612C, RP1803F, RP2303FC	1
Pribor za multitank cijsko orodje		763637-1	Vpenjalna puša	6,35	RT0700C, RP0900	1



## Kopirne šablone







Koda	Premer (Ø) (mm)	Premer luknje (Ø) (mm)	Višina (mm)	Za model	Cena z DDV
321492-3	35	30	7	3612, RP0900, RP1800F, RP1801F, RP2300FC, RP2301FC, RT0700C, M3600, M3601	
343577-5	10	8	10	3707, 3708, 3708F, 3711, 3712, RT0700C, RT0702C	
193330-7	9,5	7,7	11,5	RP1110C, RP1111C	
193331-5	11	9	11,5	RP1110C, RP1111C	
193332-3	12	10,5	14	RP1110C, RP1111C	
193333-1	12,7	11	11,5	RP1110C, RP1111C	
193334-9	16	14,5	11,5	RP1110C, RP1111C	
193335-7	20	18	13	RP1110C, RP1111C	
193336-5	27	24	13	RP1110C, RP1111C	
193337-3	29	25	13	RP1110C, RP1111C	
193338-1	30	27	13	RP1110C, RP1111C	
193339-9	40	37	13	RP1110C, RP1111C	

[Nadaljevanje...](#)

# Pribor za rezkanje in oblanje

Koda	Premer (Ø) (mm)	Premer luknje (Ø) (mm)	Višina (mm)	Za model	Cena z DDV
193340-4	24	22	13	RP1110C, RP1111C	
163080-8	29	25	15	RP1800FX, RP2300FCX, 3612, 3612C, RP0900, RT0700C, RT0702C, M3600, M3601	
164379-4	9,5	7,7	11,5	RP1800FX, RP2300FCX, 3612, 3612C, RP0900, RT0700C, RT0702C, M3600, M3601	
164388-3	12	10	9	RP1800FX, RP2300FCX, 3612, 3612C, RP0900, RT0700C, RT0702C, M3600, M3601	
164393-0	20	18	13	RP1800FX, RP2300FCX, 3612, 3612C, RP0900, RT0700C, RT0702C, M3600, M3601	
164470-8	27	24	13	RP1800FX, RP2300FCX, 3612, 3612C, RP0900, RT0700C, RT0702C, M3600, M3601	
164471-6	30	27	13	RP1800FX, RP2300FCX, 3612, 3612C, RP0900, RT0700C, RT0702C, M3600, M3601	
164472-4	40	37 (27)	13	RP1800FX, RP2300FCX, 3612, 3612C, RP0900, RT0700C, RT0702C, M3600, M3601	
164775-6	11	9	13	RP1800FX, RP2300FCX, 3612, 3612C, RP0900, RT0700C, RT0702C, M3600, M3601	
164776-4	12,7	11	13	RP1800FX, RP2300FCX, 3612, 3612C, RP0900, RT0700C, RT0702C, M3600, M3601	
165046-4	40	37	13	RP1800FX, RP2300FCX, 3612, 3612C, RP0900, RT0700C, RT0702C, M3600, M3601	
344364-5	16	14,5	13	RP1800FX, RP2300FCX, 3612, 3612C, RP0900, RT0700C, RT0702C, M3600, M3601	

## Prisloni in podnožja za nadrezkarje in rezkarje















Koda	Naziv	Za model	Enota (kos/set)	Cena z DDV	
122238-8	Podnožje za rezkarje	3700B, N3701, 3703, 4402	1		
122256-6	Držalo za vzporedne prislone	3612, 3612C	1		
122391-0	Ravno vodilo	3707, 3708	1		
122700-3	Držalo za vzporedne prislone	RP1800, RP1803F, RP2303FC, M3602	1		
122703-7	Vodilo za rezkarje z ležaji	3709, 3710, 3711, 3712, RT0700C, RT0702C, DRT50	1		
122704-5	Ravno vodilo	3709, 3711, 3712	1		

[Nadaljevanje...](#)

- Akumulat orji in polnilniki
- Pribor za akumulat orsko orodje
- Akumulat orske svetilke in pribor
- Pribor za laserske merilnike
- Pribor za rušenje in vrtanje
- Pribor za vrtanje
- Kronске žage
- Pribor za vijachenje
- Pribor za rezanje in brušenje
- Pribor za poliranje in brušenje
- Pribor za rezkanje in oblanje
- Pribor za multitank cjsko orodje
- Pribor za žaganje
- Pribor za žebjalnike in spenjalnike
- Pribor za fene
- Pribor za sesanje
- Pribor orodja za uporabo na prostem
- Pribor za nožne orodja in zaščitna oprema
- Kovčki in torbe za orodje
- Ročno orodje
- Razno
- Pribor za mešanje





# Pribor za rezkanje in oblanje

	Koda	Naziv	Za model	Enota (kos/set)	Cena z DDV
	122745-1	Ravno vodilo	3710	1	
	122965-7	Ravno vodilo	DRT50, RT0700C, RT0702C	1	
	123022-4	Vodilo za rezkarje z ležajem	3612, 3612C, RP1800F, RP1801, RP2300F, RP2301	1	
	123544-4	Podnožje za rezkarje	3707, 3708	1	
	164834-6	Ravno vodilo	3620, RP0910, RP1110C, RP0900, RP1111C	1	
	193448-4	Krožno vodilo, 100-340 mm	3706, DCO180, DCO181	1	
	193904-4	Podnožje za rezkarje	3707, 3708	1	
	194579-2	Adapter za vodilo 1.400/3.000 mm	3612, 3612C, RP0900, RP0910, RP1110C, RP1800FC, RP1801, RP2300FCX, RP2301, RT0700C	1	
	195136-9	Ravno vodilo	RP1800FX, RP1801, RP2300FCX, RP0900, RP0910, RP1110C, RT0700C, RP1803F, RP2303FC	1	
	195138-5	Palica	RP1110C, RP0910, RP0900	2/1	
	195562-2	Podnožje za rezkanje v kotu	RT0700C, RT0702C	1	
	195563-0	Potopno podnožje	RT0700C, RT0702C	1	
	195564-8	Držalo za ravno vodilo	DRT50, RT0700C, RT0702C	1	
	196615-0	Podnožje za rezkarje	RT0700C, RT0702C	1	

[Nadaljevanje...](#)

# Pribor za rezkanje in oblanje

203

Koda	Naziv	Za model	Enota (kos/set)	Cena z DDV	
198987-9	Nagibno podnožje za rezkar	RT0700C, RT0702C	1		
199089-4	Transparentno podnožje rezkarja	DRT50, RT0702C	1		
342428-9	Ravno vodilo	3612, 3612C, RP1803F, RP2303FC, M3602	1		
418647-0	Plastična zaščita pred ostružki	3711, M3700, M3702	1		
STEX122385	Vodilo za rezkarje z ležaji	3620, RP0900	1		

Akumulat orji in polnilniki

Pribor za akumulat orsko orodje

Akumulat orske svetilke in pribor

Pribor za laserske merilnike

Pribor za rušenje in vrtanje

Pribor za vrtanje

Kronske žage

Pribor za vijachenje

Pribor za rezanje in brušenje

Pribor za poliranje in brušenje

Pribor za rezkanje in oblanje

Pribor za multitank ciljsko orodje

Pribor za žaganje

Pribor za žebjalnike in spenjalnike

Pribor za fene

Pribor za sesanje

Pribor orodja za uporabo na prostem

Pribor za ploščice orodja in zaščitna oprema

Kovčki in torbe za orodje

Ročno orodje

Razno



Pribor za mešanje

## Pribor za lamelne rezkarje

### TCT žagini listi

Koda	Luknja žaginega lista (Ø) (mm)	Premer (Ø) (mm)	Število zob	Debelina reza (mm)	Največje število obratov (min <sup>-1</sup> )	Za model	Cena z DDV	
B-20644	22	100	6	4,0	12.090	3901, DPJ180, PJ7000		

### Prisloni

Koda	Naziv	Za model	Cena z DDV	
122473-8	Kotni prislon	3901		
123149-0	Kotni prislon	PJ7000, DPJ180		
415579-2	Distančna plošča	3901, PJ7000, DPJ180		

## Potopni rezalnik utorov za aluminij CA5000



## TCT žagini listi za rezalnik utorov



Žagini listi za rezanje utorov v kompozitne plošče z aluminijem, na primer v zunanje zidne panele.



Koda	Premer (Ø) (mm)	Luknja žaginega lista (Ø) (mm)	Število zob	Rezalni kot (°)	Kot (A) (°)	Število obratov - aluminij (min <sup>-1</sup> )	Za material - Aluminij	Za model	Cena z DDV
B-48832	118	20	6	90	90	12.940	•	CA5000	
B-48860	118	20	6	135	45	12.940	•	CA5000	

## Pribor za oblanje

## Skobeljni noži

	Koda	Naziv	Širina (mm)	Za model	Enota (kos/set)	Cena z DDV
	A-86175	Pritrdilna ploščica za zasučne nože	82	1902, N1923B, 1923H, KP0810, KP0810C, KP0800, DKP180, DKP181, KP001G	1	
	D-07945	HM skobeljni nož	82	1100/N, N1900B, 1902, N1923B/H, KP0810/C, KP0800, DKP180, DKP181, KP001G	2/1	
	D-07951	HM skobeljni nož	82	1100/N, N1900B, 1902, N1923B/H, KP0810/C, KP0800, DKP180, DKP181, KP001G	4/1	
	D-07967	HM skobeljni nož	82	1100/N, N1900B, 1902, N1923B/H, KP0810/C, KP0800, DKP180, DKP181, KP001G	2/1	
	D-16346	HSS skobeljni nož	82	1100, 1902, N1923H, KP0800, KP0810, DKP180, DKP181, KP001G	2/1	
	D-08822	HM skobeljni nož	110	1911B	2/1	
	D-71211	HSS skobeljni nož 110 mm	110	1911B	2/1	
	D-70910	HSS skobeljni nož	155	1805B	2/1	

[Nadaljevanje...](#)

# Pribor za rezkanje in oblanje

Koda	Naziv	Širina (mm)	Za model	Enota (kos/set)	Cena z DDV	
P-04248	HM skobeljni nož	155	1805B	2/1		
D-63666	HSS skobeljni nož	170	1806B	2/1		
P-19831	HSS skobeljni nož	300	KP301	12/1		
199911-5	HSS skobeljni nož	306	2012NB	2/1		
793346-8	HSS skobeljni nož	306	2012NB	2/1		
B-02870	HSS skobeljni nož	312	KP312S	2/1		

## Ostali pribor

Koda	Naziv	Za model	Enota (kos/set)	Cena z DDV	
122785-9	Vzporedno vodilo	KP0810, KP0810C	1		
122791-4	Vodilo za posnemanje robov	KP0810, KP0810C	1		
123004-6	Držalo za ostrenje rezil 82 mm	1902, N1923B, 1923H, KP0810, KP0810C, KP0800, DKP180, KP001G	1		
123006-2	Držalo za ostrenje rezil 155 mm	1806B	1		
123053-3	Vzporedni prislon	1806B	1		
123055-9	Držalo za ostrenje rezil 110 mm	1911B	1		
123062-2	Šablona za nastavljanje rezila 82 mm	1902, 1911B, N1923, 1923H, KP0810, KP0810C, KP0800, DKP181, KP001G	1		
161046-2	Vzporedni prislon	1100	1		
164371-0	Vzporedno vodilo	1902, 1911B	1		

Nadaljevanje...

Akumulat  
orji in  
polnilniki

Pribor za  
akumulat  
orsko  
orodje

Akumulat  
orske  
svetilke  
in pribor

Pribor za  
lasarske  
merilnike

Pribor za  
rušenje  
in vrtanje

Pribor za  
vrtanje

Kronske  
žage

Pribor za  
vijačenje

Pribor za  
rezanje  
in  
brušenje

Pribor za  
poliranje  
in  
brušenje

Pribor za  
rezkanje  
in  
oblanje

Pribor za  
multitank  
ciljsko  
orodje

Pribor za  
žaganje

Pribor za  
žebjalnike  
in  
spenjalnike

Pribor za  
fene

Pribor za  
sesanje

Pribor  
orodja za  
uporabo  
na prostem

Pribor za  
ploščne  
orodja in  
zaščitna  
oprema



Kovčki in  
torbe za  
orodje

Ročno  
orodje

Razno

Pribor za  
mešanje

# Pribor za rezkanje in oblanje

	Koda	Naziv	Za model	Enota (kos/set)	Cena z DDV
	165259-7	Vzporedno vodilo	N1923B, 1923H	1	
	191C22-0	Vodilo za posnemanje robov	DKP181, KP001G	2/1	
	191C23-8	Vzporedno vodilo	DKP181, KP0810/C, KP001G	1	
	195055-9	Vzporedno vodilo	1923B, DKP180, KP0800	1	
	342390-8	Vodilo omejevalca globine	DKP181, KP0810/C, N1923B, KP001G	1	
	762014-4	Držalo z magnetom za menjavo noža	2012NB	1	
	762016-0	Šablona za nastavljanje rezila	2012NB	1	
	JM27000328	Nastavitveni trikotnik	MLT100, LS1018L, LH1200L	1	

Akumulat orji in polnilniki
Pribor za akumulat orsko orodje
Akumulat orske svetilke in pribor
Pribor za laserske merilnike
Pribor za rušenje in vrtanje
Pribor za vrtanje
Kronske žage
Pribor za vijačenje
Pribor za rezanje in brušenje
Pribor za poliranje in brušenje
Pribor za rezkanje in oblanje
Pribor za multitank cijsko orodje
Pribor za žaganje
Pribor za žebjalnike in spenjalnike
Pribor za fene
Pribor za sesanje
Pribor orodja za uporabo na prostem
Pribor za nosenje orodja in zaščita oprema
Kovčki in torbe za orodje
Ročno orodje
Razno
Pribor za mešanje



# PRIBOR ZA MULTIFUNKCIJSKO ORODJE

Marmor	
Apnenec	
Aluminij	
Kovine	
Les	
Les z žebli	
Mavčne plošče	
Vezana plošča	
Silikon	
Pritrjevanje na ježka	
Betonski blok	
Steklena vlakna	
Nerjavno jeklo	
Barvne kovine	
Plastika, PVC	
Epoksi	
Keramične ploščice	
Zaključna dela	
Izolacija	
Pločevina	
Preproga	
Dolga življenjska doba	
BIM	
BIM TIN	
HCS	
HM/TC	



**STARLOCK**

**STARLOCK MAX**

**STARLOCK PLUS**





## Starlock rezila

Združljivo z modeli

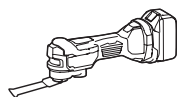

	Vpetje		
	STARLOCK	STARLOCK PLUS	STARLOCK MAX
OIS združljiva orodja	✓	-	-
Vpetje orodja	✓	✓	✓

## Segmentna rezila za les in kovino

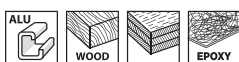

BIM



Koda	Makita ID koda	Dimenzija	Material rezila
B-64799	TMA045	85 mm	BiM
B-64808	TMA046	100 mm	BiM

## Potopna rezila za les in kovino

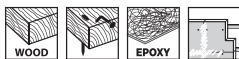

BIM



Koda	Makita ID koda	Dimenzija	Material rezila
B-64814	TMA047	32 x 50 mm	BiM
B-64814-5*	TMA047	32 x 50 mm	BiM
B-64820	TMA048	65 x 40 mm	BiM
B-64917	TMA057	10 x 30 mm	BiM
B-64923	TMA058	20 x 30 mm	BiM

\* 5 rezil v paketu

## Segmentna rezila za les



Koda	Makita ID koda	Dimenzija	Material rezila
B-64836	TMA049	85 mm	HCS

## Potopna rezila za les



Koda	Makita ID koda	Dimenzija	Material rezila
B-64842	TMA050	24 x 50 mm	HCS
B-64842-5*	TMA050	24 x 50 mm	HCS
B-64858	TMA051	32 x 50 mm	HCS
B-64858-5*	TMA051	32 x 50 mm	HCS
B-64864	TMA052	65 x 40 mm	HCS
B-64870	TMA053	32 x 50 mm	BiM
B-64870-5*	TMA053	32 x 50 mm	BiM
B-64892	TMA055	65 x 40 mm	TC/HM
B-64886	TMA054	320 x 50 mm	HCS
B-64901	TMA056	65 x 40 mm	HCS

\* 5 rezil v paketu

## Potopna rezila za kovino

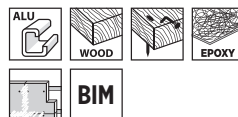

Koda	Makita ID koda	Dimenzija	Material rezila
B-64939	TMA059	32 x 50 mm	BiM
B-64939-5*	TMA059	32 x 50 mm	BiM

\* 5 rezil v paketu

## TC potopna rezila za kovino

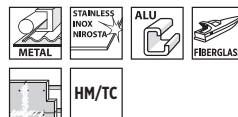

Koda	Makita ID koda	Dimenzija	Material rezila
B-64945	TMA060	20 x 40 mm	TC/HM
B-64951	TMA061	32 x 40 mm	TC/HM
B-69755	TMA079	45 x 40 mm	TC/HM

## Segmentna rezila za več materialov

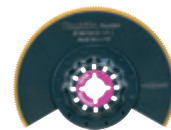
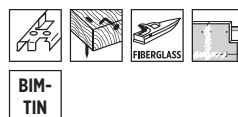

Koda	Makita ID koda	Dimenzija	Material rezila
B-64973	TMA064	85 mm	BiM-TiN



## Krožna rezila za več materialov



Koda	Makita ID koda	Dimenzija	Material rezila
B-64967	TMA063	100 mm	BiM

## Potopna rezila za več materialov



Koda	Makita ID koda	Dimenzija	Material rezila
B-69777	TMA081	53 x 40 mm	BiM

## TC potopna rezila za več materialov



Koda	Makita ID koda	Dimenzija	Material rezila
B-69761	TMA080	32 x 53 mm	TC/HM

## Rezila za silikon



Koda	Makita ID koda	Dimenzija	Material rezila
B-65006	TMA067	28 x 40 mm	HCS
B-69783	TMA082	4 x 29 mm	Nerjavno jeklo

## Večnamenska rezila za več materialov



Koda	Makita ID koda	Dimenzija	Material rezila
B-65012	TMA068	11 x 24 mm	HCS

## Strgala za več materialov



Koda	Makita ID koda	Dimenzija	Material rezila
B-64989	TMA065	52 x 26 mm	HCS
B-64995	TMA066	52 x 26 mm	HCS

## Segmentna rezila za keramiko



Koda	Makita ID koda	Dimenzija	Material rezila
B-65028	TMA067	85 mm	TC/HM
B-65040	TMA071	70 mm	TC/HM

## Diamantna segmentna rezila za keramiko



Koda	Makita ID koda	Dimenzija	Material rezila
B-65034	TMA070	85 mm	Diamant #40

## TC potopna rezila za les in steklena vlakna



Koda	Makita ID koda	Dimenzija	Material rezila
B-65084	TMA075	32 x 30 mm	TC/HM

## TC odstranjevalci abrazivnih materialov

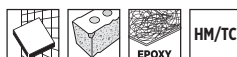

Koda	Makita ID koda	Dimenzija	Material rezila
B-65078	TMA074	70 mm	TC/HM

Akumulat  
orj in  
poinliniki

Pribor za  
akumulat  
orsko  
orodje

Akumulat  
orske  
svetilke  
in pribor

Pribor za  
lasarske  
merilnike

Pribor za  
rušenje  
in vrtanje

Pribor za  
vrtanje

Kronske  
žage

Pribor za  
vijačenje

Pribor za  
rezanje  
in  
brušenje

Pribor za  
poliranje  
in  
brušenje

Pribor za  
režkanje  
in  
oblanje

Pribor za  
multifunk  
cijsko  
orodje

Pribor za  
žaganje

Pribor za  
žebjalnike  
in  
spenjalnike

Pribor za  
fene

Pribor za  
sesanje

Pribor  
orodja za  
uporabo  
na prostem

Pribor za  
nosilne  
orodja za  
zaščitna  
oprema

Kovčki in  
torbe za  
orodje

Ročno  
orodje

Razno

Pribor za  
mešanje



## TC brusne plošče za abrazivne materiale

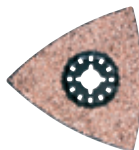

Koda	Makita ID koda	Dimenzija	Material rezila
B-65062	TMA073	78 mm	TC/HM #20
B-69799	TMA083	90 mm	TC/HM #20
B-69808	TMA084	90 mm	TC/HM #40
B-69814*	TMA085	90 mm	TC/HM #60
B-69820*	TMA086	90 mm	TC/HM #100

\* Samo za les

## Seti rezil Starlock

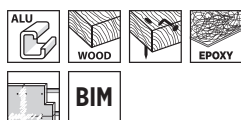

Koda	Naziv	Vsebuje
B-67480	Set potopnih rezil	TMA045, TMA047, TMA053, TMA058
B-67496	Set rezil za keramiko	TMA045, TMA048, TMA051, TMA066
B-67505	Set rezil za talne obloge	TMA058, TMA065, TMA069, TMA073
B-67511	Set rezil za mizarje	TMA045, TMA047, TMA053, 2x TMA078

## Starlock brusni papir in pribor

### Plošča za samopritrdilne brusne papirje



Koda	Makita ID koda	Dimenzija
B-65115	TMA078	93 x 93 x 93 mm

## Papir za poliranje



Koda	Granulacija	Dimenzija	Enota (kos/set)
B-21808	100		1
B-21799	280	94 x 94 x 94 mm	1
B-21814	/		1

## Brusni papir za les / long life



Koda	Granulacija	Dimenzija	Enota (kos/set)
B-21565	60		10/1
B-21571	80		10/1
B-21587	100	94 x 94 x 94 mm	10/1
B-21593	120		10/1
B-21602	180		10/1
B-22931	240		10/1
	60		
	80		
B-21559	100	94 x 94 x 94 mm	10/1
	120		
	180		

## Brusni papir za les



Koda	Granulacija	Dimenzija	Enota (kos/set)
B-21624	60		10/1
B-21630	80		10/1
B-22947	100		10/1
B-21646	120	94 x 94 x 94 mm	10/1
B-22953	150		10/1
B-21652	180		10/1
B-21668	240		10/1
	60		
	80		
B-21618	120	94 x 94 x 94 mm	10/1
	180		
	240		

## Brusni papir za odstranjevanje barve

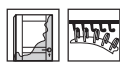

Koda	Granulacija	Dimenzija	Enota (kos/set)
B-21680	60	94 x 94 x 94 mm	10/1
B-21696	80		10/1
B-21705	100		10/1
B-22969	120		10/1
B-21711	240		10/1
B-21727	320		10/1
B-21674	60	94 x 94 x 94 mm	10/1
	80		
	100		
	240		
	320		

## Brusni papir za kamen

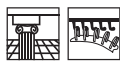

Koda	Granulacija	Dimenzija	Enota (kos/set)
B-21749	120	94 x 94 x 94 mm	10/1
B-21755	240		10/1
B-21761	400		10/1
B-21777	600		10/1
B-21783	1200		10/1
B-21733	120		94 x 94 x 94 mm
	240		
	400		
	600		
	1200		

## Starlock PLUS rezila

Združljivo z modeli

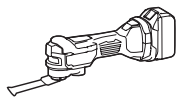

	Vpetje		
	STARLOCK	STARLOCK PLUS	STARLOCK MAX
OIS združljiva orodja	✓	-	-
STARLOCK MAX	✓	✓	✓

## Potopna rezila za les in kovino



BIM



Koda	Makita ID koda	Dimenzija	Material rezila
B-66329	MAP001	32 x 60	BIM
B-66335	MAP002	65 x 50	BIM

## Potopna rezila za les

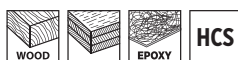

HCS



Koda	Makita ID koda	Dimenzija	Material rezila
B-66341	MAP003	32 x 60	HCS

## TC potopna rezila za kovine



HM/TC



Koda	Makita ID koda	Dimenzija	Material rezila
B-66357	MAP004	32 x 50	TC/HM
B-66363	MAP005	45 x 50	TC/HM

## TC potopna rezila za več materialov

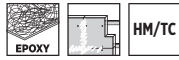

Koda	Makita ID koda	Dimenzija	Material rezila
B-66379	MAP006	32 x 50	TC/HM
B-66385	MAP007	52 x 50	TC/HM

## TC potopna rezila za abrazivne materiale

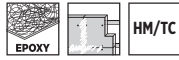

Koda	Makita ID koda	Dimenzija	Material rezila
B-66391	MAP008	53 x 40	TC/HM #40

Akumulat orji in polnilniki  
Pribor za akumulat orsko orodje  
Akumulat orske svetilke in pribor  
Pribor za lasarske merilnike  
Pribor za rušenje in vrtanje  
Pribor za vrtanje  
Kronске žage  
Pribor za vijachenje  
Pribor za rezanje in brušenje  
Pribor za poliranje in brušenje  
Pribor za rezkanje in oblanje  
Pribor za multifunkcijsko orodje  
Pribor za zaganje  
Pribor za žebjalnike in spenjalnike  
Pribor za fene  
Pribor za sesanje  
Pribor orodja za uporabo na prostem  
Pribor za nosenje orodja v zaščitni oprema  
Kovčki in torbe za orodje  
Ročno orodje  
Razno  
Pribor za mešanje

## Starlock MAX rezila

Združljivo z modeli

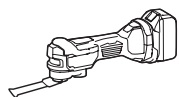

Vpetje



OIS združljiva orodja



STARLOCK MAX



## Segmentna rezila za les in kovino

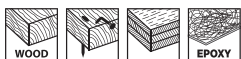

BIM



Koda	Makita ID koda	Dimenzija	Material rezila
B-66422	MAM003	100 x 50	BIM

## Potopna rezila za les in kovino

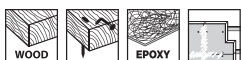

BIM



Koda	Makita ID koda	Dimenzija	Material rezila
B-66400	MAM001	32 x 80	BIM
B-66416	MAM002	52 x 70	BIM

## Potopna rezila za les in kovino



HCS



Koda	Makita ID koda	Dimenzija	Material rezila
B-66438	MAM004	32 x 80	HCS

## TC potopna rezila za kovino



HM/TC



Koda	Makita ID koda	Dimenzija	Material rezila
B-66444	MAM005	32 x 70	TC/HM

## TC potopna rezila za več materialov



HM/TC



Koda	Makita ID koda	Dimenzija	Material rezila
B-66450	MAM006	32 x 70	TC/HM

## Rezila za silikon

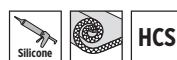

HCS



Koda	Makita ID koda	Dimenzija	Material rezila
B-66466	MAM007	32 x 70	HCS
B-66472	MAM008	32 x 55	HCS

## TC brusne plošče za abrazivne materiale



HM/TC

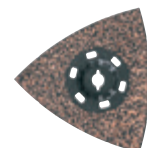

Koda	Makita ID koda	Dimenzija	Material rezila
B-66553	MAM015	116	TC/HM #20
B-66569	MAM016	116	TC/HM #40
B-66575*	MAM017	116	TC/HM #60
B-66581*	MAM018	116	TC/HM #100

\*Samo za les

## TC segmentna rezila za abrazivne materiale



HM/TC



Koda	Makita ID koda	Dimenzija	Debelina rezila	Material rezila
B-66494	MAM009	68 x 10	1,5 mm	TC/HM #50
B-66503	MAM010	68 x 30	2,2 mm	TC/HM #30
B-66531	MAM013	68 x 30	2,1 mm	TC/HM #40
B-66547	MAM014	100 x 50	1,9 mm	TC/HM #40



# Pribor za multifunkcijsko orodje

## Diamantna segmentna rezila za abrazivne materiale



Koda	Makita ID koda	Dimenzija	Debelina rezila	Material rezila
B-66525	MAM012	68 x 10	1,5 mm	Diamant #40
B-66519	MAM011	68 x 30	2,2 mm	Diamant #40



- Akumulat orji in polnilniki
- Pribor za akumulat orsko orodje
- Akumulat orske svetilke in pribor
- Pribor za laserske merilnike
- Pribor za rušenje in vrtanje
- Pribor za vrtanje
- Kronске žage
- Pribor za vijacanje
- Pribor za rezanje in brušenje
- Pribor za poliranje in brušenje
- Pribor za rezkanje in oblanje
- Pribor za multitfunkcijsko orodje
- Pribor za žaganje
- Pribor za zebjalnike in spenjalnike
- Pribor za fene
- Pribor za sesanje
- Pribor orodja za uporabo na prostem
- Pribor za nožne in zaščitna oprema
- Kovčki in torbe za orodje
- Ročno orodje
- Razno
- Pribor za mešanje

# STARLOCK

## BRUSNI PAPIRJI



★★ Priporočljivo ★ Sprejemljivo Brez ocene

Za material	Obdelava	Zmatost	Artikel	Barva	Lak	Polnila	Fasada	Les/lesni materiali	Mehak les	Trd les	Vežane plošče	Iveme plošče	Kovine	Jeklo	Kamen	Marmor	Granit	Steklo	Pleksi steklo	Corian	Steklena vlakna		
Les <b>LONG LIFE</b>	Grobo	60	B-21565																				
		80	B-21571																				
	Srednje	100	B-21587					★★	★★	★★	★★	★★	★★	★									
		120	B-21593																				
		180	B-21602																				
		240	B-22931																				
Les	Grobo	60	B-21624																				
		80	B-21630																				
	Srednje	100	B-22947					★★	★	★★	★★	★★											
		120	B-21646																				
		150	B-22953																				
		180	B-21652																				
Fino	240	B-21668																					
Barva	Grobo	60	B-21680																				
		80	B-21696																				
	Srednje	100	B-21705	★★	★★	★★	★★			★			★	★									
		120	B-22969																				
		240	B-21711																				
		320	B-21727																				
Kamen	Srednje	120	B-21749																				
		240	B-21755																				
	Fino	400	B-21761	★	★★										★	★	★	★	★	★	★	★	
		Zelo fino	600	B-21777																			
	1200	B-21783																					





# PRIBOR ZA ŽAGANJE

- Kovine 
- Aluminij 
- Nerjavno jeklo 
- Steklena vlakna 
- Les z žebli 
- Les 
- Sendvič paneli 
- Corian 
- Laminat 
- Malta 
- Plastika, PVC 
- Led 
- Fin, gladek rez 
- Grobi rez 
- Vzdolžni rez 
- Prečni rez 
- Hitro rezanje 
- Bajonetno vpetje 
- Makita vpetje 
- Stabilna in kotna žaga 
- Namizna krožna žaga 
- Ročna krožna žaga 
- Akumulatorska ročna krožna žaga 
- Akumulatorska sabljasta žaga 
- Akumulatorska stabilna kotna žaga 
- Akumulatorska vbodna žaga 
- Dolga življenjska doba 



# ŽAGINI LISTI

## OBLIKA ZOB

ATB	ATBR	Hi-ATB	ATAF	ATAFR
Izmenična smer naklona zgornjega roba zob.	Z dodanim ravnim zobom na ATB konfiguracijo za lažje ravno rezanje.	Izmenična smer zgornjega roba zob z večjim naklonom	Izmenična smer naklona zgornjega in stranskega roba zob.	Izmenična smer naklona zgornjega in stranskega roba zob z vmesnim ravnim zobom.

M-FORCE	FTG	TCG	MTCG	SMTCG
Zobje v obliki črke V imajo več rezalnih robov, s čimer zagotovijo zelo čiste reze.	Raven zgornji rob zob.	Izmenični trapezoidni in ravni zobje.	Izmenična postavitev ravnih zob z odrezanim zgornjim robom na eni ali drugi strani.	Izmenična postavitev trapezoidnega roba zoba z daljšo stranico na levi ali desni strani.

## TEHNOLOGIJE

LASERSKO OBLIKOVANA REŽA	PTFE PREVLEKA	VSTAVLJEN ZOB	PCD ZOB
Sistem za dušenje vibracij s sintetično smolo, naneseno v lasersko oblikovano zarezo na žaginem listu, za lepše in tišje reze.	PTFE (politetrafluoroetilenska) prevleka za zmanjšanje sprijemanja ostankov in zmanjšanje upora.	Oblika vstavljenih zob močno poveča površino spoja plošča-zob za večjo podporo in moč zoba.	PCD (diamant v polikristalni obliki) zobje so izjemno trdni in odporni proti obrabi. Žagini listi s PCD zobmi so najboljša izbira za dolgotrajno učinkovitost pri rezanju vlakno-cementnih plošč.

# EFFICUT ŽAGINI LISTI ZA LES



## OBLIKA



**OSTER ZGORNJI ROB**  
Omogoča gladko rezanje z manj napora.



**UKRIVLJEN SREDNI DEL**  
Povečana učinkovitost odvajanja odpadkov.



**OŽJI SPODNJI DEL**  
Ožja oblika zmanjša upor pri rezanju in podaljšuje čas delovanja akumulatorja.

### VEČ OPRAVLJENEGA DELA



### HITREJŠE REZANJE



### DALJŠA ŽIVLJENJSKA DOBA AKU.



### KOLIČINA OPRAVLJENEGA DELA Z ENIM POLNJENJEM AKUMULATORJA

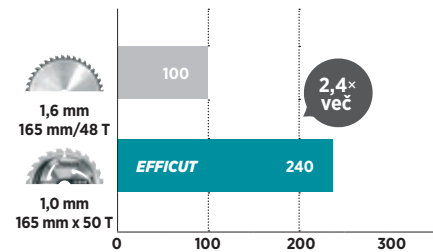

#### OPOMBA:

- Rezultati preizkusa so odvisni od trdote lesa...
- Vrednosti v diagramih so relativne vrednosti, kjer ima zmogljivost rezanja z Makita ploščo (debelina: 1,0 mm) indeks 100.



# EFFICUT ŽAGINI LISTI ZA KOMPOZITNE MATERIALE



## OBLIKA



**UKRIVLJEN SREDNI DEL**  
Povečana učinkovitost odvajanja odpadkov.



**OŽJI SPODNJI DEL**  
Ožja oblika zmanjša upor pri rezanju in podaljšuje čas delovanja akumulatorja.

### KOLIČINA OPRAVLJENEGA DELA Z ENIM POLNJENJEM AKUMULATORJA

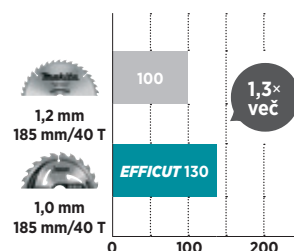

Akumulator BL1860B  
Kompozitni pod 137mm x 23mm

Dodelana oblika Efficut zob za rezanje kompozitnih materialov.

- izboljšana trdota konic rezila
- topi kot konic za podaljšano življenjsko dobo in večjo količino opravljenega dela z enim polnjenjem akumulatorja.

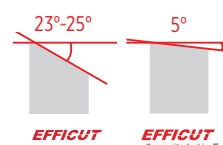

### ŽIVLJENJSKA DOBA

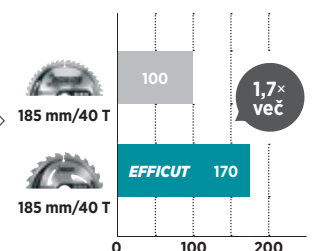

Akumulator BL1860  
Kompozitni pod 139mm x 22mm



# EFFICUT ŽAGINI LISTI ZA KOVINO

## OBLIKA



### VZDRŽLJIVA KONICA

Posebna oblika konice za manjšo obrabo žaginega lista.

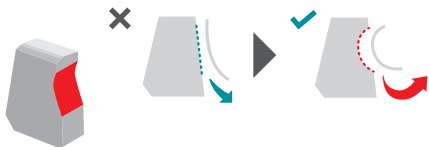

### UKRIVLJEN SREDNI DEL

Povečana učinkovitost odvajanja odpadkov.

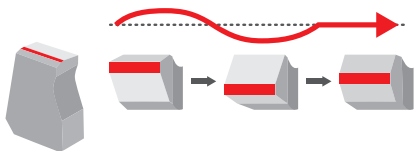

### IZMENIČNA OBLIKA KONICE

Zagotavlja stabilno in ravno rezanje.

## VEČ OPRAVLJENEGA DELA

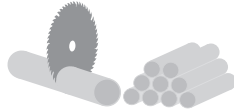

## HITREJŠE REZANJE



## DALJŠA ŽIVLJENJSKA DOBA AKU.



**EFFICUT**  
Metal



## KOLIČINA OPRAVLJENEGA DELA Z ENIM POLNJENJEM AKUMULATORJA

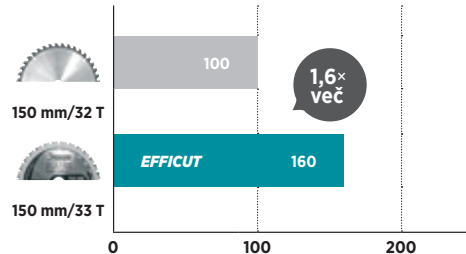

OPOMBA: Test je bil opravljen z akumulatorsko žago za kovine DCS553 z 18 V / 6,0 Ah akumulatorjem. Material: cev iz karbonskega jekla premera 31 mm in debeline 3 mm.



# EFFICUT ŽAGINI LISTI ZA ALUMINIJ

## OBLIKA



### TRŠE KONICE Z MANJ KRUŠENJA

Posebno zasnovana konica zoba izboljša učinkovitost rezanja in vzdržljivost rezila.



### ODLIČNO RAVNO REZANJE

Obremenitev na konico zoba je enakomerno razporejena za manj tresljajev in posledično čistejši, bolj raven rez ter povečano obstojnost konic.



### ZMANJŠAN UPOR PRI REZANJU

Manj upora pri rezanju in boljša obstojnost rezila.



### ODLIČEN IZMET OPILKOV

Priporočamo k daljši življenjski dobi akumulatorja z zmanjšanjem upora pri rezanju.

## VEČ OPRAVLJENEGA DELA

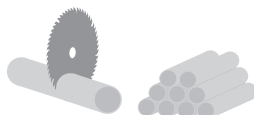

## HITREJŠE REZANJE



## DALJŠA ŽIVLJENJSKA DOBA AKU.



## ČISTI REZ

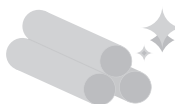

**EFFICUT**  
Aluminum



## KOLIČINA OPRAVLJENEGA DELA Z ENIM POLNJENJEM AKUMULATORJA

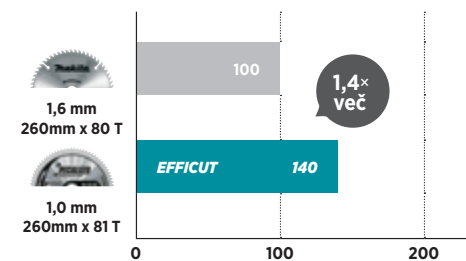

Akumulator BL1860B x2  
Profil iz aluminija, 45x45 mm, t=2 mm



## TCT žagini listi



### TCT žagini listi za les

Novo razviti žagini listi za les nudijo kakovost standardnih listov za les po nižji ceni. Odlikuje jih odlično razmerje med ceno in kakovostjo.



Koda	Žagin list (Ø) (mm)	Luknja žaginega lista (Ø) (mm)	Debelina rezila (mm)	Število zob	Debelina reza (mm)	Rezalni kot (°)	Oblika zob	Največje število obratov (min <sup>-1</sup> )	Cena z DDV
D-64951	190	30	1,4	24	2,2	15	ATB	8.040	
D-64967	190	30	1,4	40	2,2	15	ATB	8.040	
D-64973	190	30	1,4	40	2	18	ATB	8.040	
D-72291	210	30	1,6	24	2,5	15	ATB	7.170	
D-72300	210	30	1,6	40	2,5	15	ATB	7.170	
D-74049	255	30	1,8	40	2,6	15	ATB	5.870	
D-65377	260	30	1,8	40	2,6	15	ATB	5.870	
D-65383	260	30	1,8	60	2,6	15	ATB	5.870	
D-65399	260	30	1,8	80	2,6	12	ATB	5.870	
D-65408	260	30	1,8	100	2,6	12	ATB	5.870	
D-74077	260	30	1,8	40	2,6	15	ATB	5.870	
D-72316	305	30	2,0	60	2,8	15	ATB	5.000	
D-72322	305	30	2,0	80	2,8	15	ATB	5.000	
D-72338	305	30	2,0	100	2,8	15	ATB	5.000	

### MForce žagini listi

Revolucionarna in napredna zasnova zob, ki postavlja nove mejnike tehnologije žaginskih listov. Dvostransko ukrivljen zob ima ostrejšo robove, "M" oblika pa poveča učinkovitost rezanja, kot da bi imel žagin list dvojno število zob. Večje območje obrabe in več rezalne površine podaljšujeta življenjsko dobo MForce žaginskih listov, ki imajo skoraj 2x daljšo življenjsko dobo od običajnih. Ozka plošča in ozke zareze zmanjšujejo trenje in omogočajo manjši pritisk proti obdelovancu ter ščitijo motor vaše naprave. GLADKI REZI "M-oblika" zob ima večjo rezalno površino, ki omogoča izdelavo bolj gladkih rezov. S 24 zobmi so "MForce" žaginski listi enako učinkoviti kot običajni žaginski listi z 48 zobmi.



Koda	Žagin list (Ø) (mm)	Luknja žaginega lista (Ø) (mm)	Debelina rezila (mm)	Število zob	Debelina reza (mm)	Rezalni kot (°)	Oblika zob	Največje število obratov (min <sup>-1</sup> )	Cena z DDV
B-07886	165	20	1,2	10	2	15	M-FORCE	9.250	
B-07892	165	30	1,2	10	2	15	M-FORCE	9.250	
B-07901	165	20	1,2	16	2	15	M-FORCE	9.250	
B-08006	165	20	1,2	24	2	15	M-FORCE	9.250	
B-07917	170	30	1,2	16	2	15	M-FORCE	8.980	
B-08012	170	30	1,2	24	2	15	M-FORCE	8.980	
B-07923	180	20	1,2	16	2	15	M-FORCE	8.480	
B-07939	180	30	1,2	16	2	15	M-FORCE	8.480	
B-08028	180	20	1,2	24	2	15	M-FORCE	8.480	
B-08034	180	30	1,2	24	2	15	M-FORCE	8.480	
B-07945	185	30	1,2	16	2	15	M-FORCE	8.250	
B-08040	185	30	1,2	24	2	15	M-FORCE	8.250	
B-07951	190	15,88	1,2	12	2	15	M-FORCE	8.040	

Nadaljevanje...

 Akumulat  
orji in  
pnilniki

 Pribor za  
akumulat  
orsko  
orodje

 Akumulat  
orske  
svetilke  
in pribor

 Pribor za  
laserske  
merilnike

 Pribor za  
rušenje  
in vrtanje

 Pribor za  
vrtanje

 Kronske  
žage

 Pribor za  
vijačenje

 Pribor za  
rezanje  
in  
brušenje

 Pribor za  
poliranje  
in  
brušenje

 Pribor za  
rezkanje  
in  
oblanje

 Pribor za  
multifunk  
cijsko  
orodje

 Pribor za  
žaganje

 Pribor za  
žebjalnike  
in  
spenjalnike

 Pribor za  
fene

 Pribor za  
sesanje

 Pribor  
orodja za  
uporabo  
na prostem

 Pribor za  
protežne  
orodja in  
zaščitna  
oprema

 Kovčki in  
torbe za  
orodje

 Ročno  
orodje

Razno

 Pribor za  
mešanje



# Pribor za žaganje

Koda	Žagin list (Ø) (mm)	Luknja žaginega lista (Ø) (mm)	Debelina rezila (mm)	Število zob	Debelina reza (mm)	Rezalni kot (°)	Oblika zob	Največje število obratov (min <sup>-1</sup> )	Cena z DDV
B-07967	190	30	1,2	12	2	15	M-FORCE	8.040	
B-08056	190	30	1,2	24	2	15	M-FORCE	8.040	
B-08062	190	15,88	1,2	24	2	15	M-FORCE	8.040	
B-07973	210	30	1,4	16	2,3	15	M-FORCE	7.300	
B-08078	210	30	1,4	24	2,3	15	M-FORCE	7.300	
B-08109	210	30	1,4	40	2,3	15	M-FORCE	7.300	
B-07989	230	30	1,6	18	2,3	15	M-FORCE	6.640	
B-08084	230	30	1,6	24	2,3	15	M-FORCE	6.640	
B-08115	230	30	1,6	40	2,6	15	M-FORCE	6.640	
B-07995	235	30	1,6	20	2,3	15	M-FORCE	6.500	
B-08090	235	30	1,6	24	2,3	15	M-FORCE	6.500	
B-08121	235	30	1,6	40	2,3	15	M-FORCE	6.500	



## MAKForce žagini listi

Široka izbira žaginskih listov za vse vrste in modele prenosnih krožnih žag. S širokim razponom velikosti od 140 do 355 mm in števila zob od 10 do 60, MAKForce žaginski listi omogočajo načine uporabe od grobega in prečnega rezanja, do izjemno natančnega prečnega rezanja.



# MAKFORCE

Koda	Žagin list (Ø) (mm)	Luknja žaginega lista (Ø) (mm)	Debelina rezila (mm)	Število zob	Debelina reza (mm)	Rezalni kot (°)	Oblika zob	Največje število obratov (min <sup>-1</sup> )	Cena z DDV
B-08137	140	15,88	1	12	1,5	20	ATB	10.910	
B-08280	150	20	1,5	24	2,4	20	ATB	10.180	
B-08143	160	20	1,5	16	2,4	20	ATB	9.540	
B-08296	160	20	1,5	24	2,4	20	ATB	9.540	
B-08420	160	20	1,5	40	2,4	20	ATB	9.540	
B-08159	165	20	1,4	10	2	20	FTG	9.250	
B-08165	165	30	1,5	10	2	20	FTG	9.250	
B-08305	165	30	1,5	24	2,4	20	ATB	9.250	
B-08436	165	30	1,5	40	2,4	20	ATB	9.250	
B-08171	170	30	1,5	16	2,4	20	ATB	8.980	
B-08311	170	30	1,5	24	2,4	20	ATB	8.980	
B-08442	170	30	1,5	40	2,4	20	ATB	8.980	
B-08187	180	20	1,5	16	2,4	20	ATB	8.480	
B-08193	180	30	1,5	16	2,4	20	ATB	8.480	
B-08327	180	20	1,5	24	2,4	20	ATB	8.480	
B-08333	180	30	1,5	24	2,4	20	ATB	8.480	
B-08458	180	20	1,5	40	2,4	20	ATB	8.480	
B-08464	180	30	1,5	40	2,4	20	ATB	8.480	
B-08349	185	15,88	1,2	24	1,8	20	ATB	8.250	
B-08470	185	15,88	1,5	40	1,8	20	ATB	8.250	
B-08224	190	30	1,4	12	2	20	FTG	8.040	
B-08355	190	30	1,4	24	2,2	20	ATB	8.040	
B-08361	190	15,88	1,4	24	2,2	20	ATB	8.040	
B-08486	190	30	1,4	40	2,2	20	ATB	8.040	
B-08492	190	15,88	1,4	40	2,2	20	ATB	8.040	
B-08551	190	30	1,4	60	2,2	15	ATAF	8.040	
B-08230	210	30	1,6	16	2,4	20	ATB	7.300	
B-08377	210	30	1,6	24	2,4	20	ATB	7.300	
B-08501	210	30	1,6	40	2,4	20	ATB	7.300	

[Nadaljevanje...](#)

# Pribor za žaganje

Koda	Žagin list (Ø) (mm)	Luknja žaginega lista (Ø) (mm)	Debelina rezila (mm)	Število zob	Debelina reza (mm)	Rezalni kot (°)	Oblika zob	Največje število obratov (min <sup>-1</sup> )	Cena z DDV
B-08246	230	30	1,6	18	2,6	20	ATB	6.640	
B-08383	230	30	1,6	24	2,3	20	ATB	6.640	
B-08517	230	30	1,6	40	2,6	20	ATB	6.640	
B-08567	230	30	1,8	60	2,8	15	ATAF	6.640	
B-08399	235	30	1,6	20	2,3	20	ATB	6.500	
B-08408	235	30	1,6	24	2,3	20	ATB	6.500	
B-08523	235	30	1,6	40	2,6	20	ATB	6.500	
B-08589	235	30	1,8	60	2,8	15	ATAF	6.500	
B-08268	270	30	1,8	24	2,6	20	ATB	5.650	
B-08539	270	30	1,6	40	2,6	20	ATB	5.650	
B-08573	270	30	1,8	60	2,8	15	ATAF	5.650	
B-08274	355	30	2,2	24	3	20	ATB	4.300	
B-08414	355	30	2,2	40	3	20	ATB	4.300	
B-08545	355	30	2,2	60	3	20	ATB	4.300	
B-08595	355	30	1,8	60	2,8	15	ATAF	4.300	

## MAKBlade Plus žagini listi

MAKBlade Plus žagini listi za stabilne in zajeralne žage imajo edinstveno in patentirano tehnologijo. Izdelani so tako, da zmanjšujejo vibracije in so izjemno tihi. S tem omogočajo prijetno delovno okolje, so bolj vzdržljivi in zagotavljajo visoko zanesljivost naprav. Zaradi manj vibracij je rezanje natančnejše, površina pa bolj gladka, saj se žagini ne premikajo. To zagotavlja tudi daljšo življenjsko dobo zob iz volframovega karbida, ki je veliko daljša od običajnih zob prevlečenih samo s karbidom. Prevlečeni s posebno prevleko za zmanjševanje trenja. Prevleka omogoča enostavno gibanje rezila in štiti pred korozijo in smolo.



Koda	Žagin list (Ø) (mm)	Luknja žaginega lista (Ø) (mm)	Debelina rezila (mm)	Število zob	Debelina reza (mm)	Rezalni kot (°)	Oblika zob	Največje število obratov (min <sup>-1</sup> )	Cena z DDV
B-56502	165	20	1,4	64	1,9	10	ATB	9.250	
B-08604	190	20	1,6	24	2,2	5	ATB	8.040	
B-08757	190	20	1,4	60	2	5	ATAF	8.040	
B-08822	200	30	1,6	60	2,6	15	ATB	7.630	
B-09802	200	30	1,6	36	2,6	20	ATB	7.630	
B-08610	216	30	1,6	24	2,4	5	ATAF	7.070	
B-08632	216	30	1,6	48	2,4	5	ATAF	7.070	
B-08676	216	30	1,6	60	2,1	5	ATAF	7.070	
B-08791	216	30	1,8	80	2,8	5	ATAF	7.070	
B-08838	250	30	1,8	80	2,8	15	ATB	6.110	
B-09818	250	30	1,8	40	2,8	20	ATB	6.110	
B-08626	255	30	1,8	32	2,3	5	ATB	5.990	
B-08648	255	30	1,8	40	2,4	5	ATAF	5.990	
B-08682	255	30	1,8	60	2,3	5	ATAF	5.990	
B-08763	255	30	1,8	72	2,4	5	ATAF	5.990	
B-08654	260	30	1,8	40	2,3	5	ATAF	5.870	
B-08698	260	30	1,8	60	2,3	5	ATAF	5.870	
B-08707	260	30	1,8	70	2,3	5	ATAF	5.870	
B-08779	260	30	1,8	80	2,3	5	ATAF	5.870	
B-08800	260	30	1,8	100	2,3	5	ATAF	5.870	
B-08844	260	30	1,8	80	2,8	15	ATB	5.870	
B-09824	260	30	1,8	48	2,8	20	ATB	5.870	
B-17712	260	30	1,6	24	2,3	20	ATAF	5.870	
B-08850	300	30	1,8	100	2,8	15	ATB	5.090	
B-09830	300	30	1,8	48	2,8	20	ATB	5.090	
B-08660	305	30	1,8	40	2,3	5	ATAF	5.000	

[Nadaljevanje...](#)

- Akumulat orji in polnilniki
- Pribor za akumulat orske orodje
- Akumulat orske svetilke in pribor
- Pribor za lasarske merilnike
- Pribor za rušenje in vrtanje
- Pribor za vrtanje
- Kronske žage
- Pribor za vijačenje
- Pribor za rezanje in brušenje
- Pribor za poliranje in brušenje
- Pribor za rezkanje in oblanje
- Pribor za multitrak cliko orodje
- Pribor za žaganje
- Pribor za žebjalnike in spenjalnike
- Pribor za fene
- Pribor za sesanje
- Pribor orodja za uporabo na prostem
- Pribor za ploščo orodja za zaščita optima
- Kovčki in torbe za orodje
- Ročno orodje
- Razno
- Pribor za mešanje

Koda	Žagin list (Ø) (mm)	Luknja žaginega lista (Ø) (mm)	Debelina rezila (mm)	Število zob	Debelina reza (mm)	Rezalni kot (°)	Oblika zob	Največje število obratov (min <sup>-1</sup> )	Cena z DDV
B-08713	305	30	1,8	60	2,3	5	ATAF	5.000	
B-08729	305	30	2	60	2,6	5	ATAF	5.000	
B-08735	305	30	1,9	70	2,5	0	ATAF	5.000	
B-08785	305	30	1,8	80	2,3	5	ATAF	5.000	
B-08816	305	30	1,8	100	2,3	5	ATAF	5.000	
B-08866	350	30	2	100	3	15	ATB	4.360	
B-09846	350	30	2,5	56	3,5	20	ATB	4.360	

## MAKBlade žagini listi

Široka izbira žaginskih listov za vse vrste in modele stabilnih in kotnih žag, vključno z akumulatorskimi. S širokim razponom velikosti od 190 – 305 mm in števila zob od 24 – 100, MAKBlade žagini listi omogočajo načine uporabe od grobega rezanja, do izjemno natančnega rezanja. Togi in natančno poravnani žaginski listi absorbirajo udarce in zagotavljajo dobro smerno stabilnost. Fini zobje so bolj obstojni, kar omogoča daljšo življenjsko dobo robov rezila in zmanjšujejo obremenitev naprave in žaginega lista. Ozka rezila imajo nizko obrabo in zagotavljajo gladko delovanje.



Koda	Žagin list (Ø) (mm)	Luknja žaginega lista (Ø) (mm)	Debelina rezila (mm)	Število zob	Debelina reza (mm)	Rezalni kot (°)	Oblika zob	Največje število obratov (min <sup>-1</sup> )	Cena z DDV
B-08894	190	20	1,6	24	2,2	5	ATB	8.040	
B-08953	190	20	1,6	48	2,2	5	ATB	8.040	
B-08872	216	30	1,6	40	2,1	10	ATB	7.070	
B-08903	216	30	1,6	24	2,4	5	ATB	7.070	
B-08969	216	30	1,6	48	2,4	5	ATB	7.070	
B-09058	216	30	1,4	60	2	5	ATB	7.070	
B-09092	216	30	1,8	100	2,8	5	ATB	7.070	
B-08919	250	30	1,6	32	2,4	5	ATAF	6.110	
B-08975	250	30	1,8	48	2,4	5	ATB	6.110	
B-09008	250	30	1,8	60	2,3	5	ATB	6.110	
B-09064	250	30	1,8	72	2,4	5	ATB	6.110	
B-09101	250	30	1,8	100	2,3	5	ATB	6.110	
B-08888	255	30	1,6	48	2,1	10	ATB	5.990	
B-08925	255	30	1,8	32	2,3	5	ATAF	5.990	
B-09014	255	30	1,8	60	2,3	5	ATB	5.990	
B-08931	260	30	1,8	32	2,3	5	ATAF	5.870	
B-08981	260	30	1,8	40	2,3	5	ATB	5.870	
B-09020	260	30	1,8	60	2,3	5	ATB	5.870	
B-09070	260	30	1,8	80	2,3	5	ATB	5.870	
B-09117	260	30	1,8	100	2,3	5	ATB	5.870	
B-08947	305	30	1,8	32	2,3	5	ATAF	5.000	
B-08997	305	30	1,8	40	2,3	5	ATB	5.000	
B-09036	305	30	1,8	60	2,3	5	ATB	5.000	
B-09086	305	30	1,8	80	2,3	5	ATB	5.000	
B-09123	305	30	1,8	100	2,3	5	ATB	5.000	
B-46171	315	30	2,0	28	2,8	20	ATB	4.850	
B-46187	315	30	2,0	48	2,8	10	ATB	4.850	
B-46193	315	30	2,0	60	2,8	10	ATB	4.850	

## Specialized - žagini listi za akumulatorske žage

Premium žagini listi so izdelani posebej za akumulatorske žage. Žagini listi so namenjeni rezanju lesa in se prilagajajo vsem akumulatorskim krožnim žagam – vse z Makita kvaliteto! Izjemno tanki in dobro uravnoteženi jekleni žagini listi omogočajo natančno delo. Zobje so zasnovani za izdelavo univerzalnih rezov v les. Natančni in dobro nabrušeni HM rezalni robovi žaginega lista omogočajo enostavno izdelavo gladkih rezov in daljšo življenjsko dobo. Žagin list B-09248 je narejen za levo pozicijo na orodju. Primeren za DHS680 ali DSS610.



Koda	Žagin list (Ø) (mm)	Luknja žaginega lista (Ø) (mm)	Debelina rezila (mm)	Število zob	Debelina reza (mm)	Rezalni kot (°)	Oblika zob	Največje število obratov (min <sup>-1</sup> )	Cena z DDV
B-14607	85	20	0,7	20	1,0	10	ATB	2.240	
B-16885	85	15	0,7	20	1,0	10	ATB	2.240	
B-09139	136	10	1,0	24	1,5	20	ATAF	4.500	
B-10643	136	20	1,0	16	1,5	20	ATAF	4.500	
B-40294	136	20	1,0	50	1,6	0	ATB	4.500	
E-06890	150	20	1,0	25	1,4	23	ATAF	10.180	
B-09151	160	20	1,0	24	1,5	20	ATAF	4.770	
B-09167	165	20	1,0	24	1,5	20	ATAF	6.500	
B-09173	165	20	1,0	24	1,5	20	ATAF	6.500	
B-09232	165	20	1,0	40	1,6	18	ATAF	6.500	
B-09248	165	20	1,0	40	1,6	18	ATAF	6.500	
B-53198	165	20	1,0	44	1,45	23	ATAFR	4.770	
B-53207	165	20	1,0	44	1,45	23	ATAFR	6.500	
B-56502	165	20	1,4	64	1,9	10	ATB	9.250	
B-56699	165	20	1,4	28	2	15	ATB	9.250	
B-56708	165	20	1,25	48	1,85	8	ATB	9.250	
B-56714	165	20	1,4	56	2	-3	TCG	9.250	
B-56720	165	20	1,4	60	2	5	HI-ATB	9.250	
B-56736	165	20	1,4	60	2	5	TCG	9.250	
B-56742	165	20	1,4	48	2	5	ATAF	9.250	
B-57320	165	20	1	56	1,45	23	ATAF	9.250	
B-62979	165	20	1,0	25	1,4	23	ATAF	9.250	
B-09195	190	30	1,4	24	2,0	20	ATAF	3.000	
B-09254	190	30	1,4	40	2,0	10	ATAF	3.000	
B-21967	190	20	1,4	24	1,9	-18	ATB	3.000	
B-53291	190	20	1,3	60	1,7	20	ATB	8.040	
B-64185	190	30	1,0	24	1,45	23	ATAF	8.040	
B-68622	190	30	1	45	1,45	23	ATAF	8.040	
E-01909	235	30	1,5	24	2,2	20	ATBR	6.500	

## Specialized - žagini listi za potopne žage

Žagini listi so posebej zasnovani za potopne žage. Za rezanje lesa in aluminija (samo B-09307), saj ustvarjajo gladko in enakomerno površino reza. Žagini listi za potopne žage imajo podobne specifikacije kot premium žagini listi MAKBlade Plus s patentirano tehnologijo dušenja vibracij. Žagini listi z manj vibracijami so bolj natančni in se manj premikajo ter omogočajo lažje zarezovanje v obdelovane. Sistem za dušenje vibracij sestavlja sintetična smola, ki je nanešena v lasersko zarezo na žaginem listu. Posebna zasnova osnove žaginega lista omogoča uporabo zelo tankih rezil in izdelavo natančnih rezov.



Koda	Žagin list (Ø) (mm)	Luknja žaginega lista (Ø) (mm)	Debelina rezila (mm)	Število zob	Debelina reza (mm)	Rezalni kot (°)	Oblika zob	Največje število obratov (min <sup>-1</sup> )	Cena z DDV
B-09260	160	20	1,6	28	2,2	23	ATB	9.540	

[Nadaljevanje...](#)

Akumulatorji in polnilniki

Pribor za akumulatorsko orodje

Akumulatorske svetilke in pribor

Pribor za laserske merilnike

Pribor za rušenje in vrtanje

Pribor za vrtanje

Kronske žage

Pribor za vijachenje

Pribor za rezanje in brušenje

Pribor za poliranje in brušenje

Pribor za rezkanje in oblanje

Pribor za multitank orodje

Pribor za žaganje

Pribor za žebjalnike in spenjalnike

Pribor za fene

Pribor za sesanje

Pribor orodja za uporabo na prostem

Pribor za čiščenje in zaščitna oprema

Kovčki in torbe za orodje

Ročno orodje

Razno

Pribor za mešanje

Koda	Žagin list (Ø) (mm)	Luknja žaginega lista (Ø) (mm)	Debelina rezila (mm)	Število zob	Debelina reza (mm)	Rezalni kot (°)	Oblika zob	Največje število obratov (min <sup>-1</sup> )	Cena z DDV
B-09276	160	20	1,6	48	2,2	8	ATB	9.540	
B-09282	165	20	1,6	28	2,2	23	ATB	9.250	
B-09298	165	20	1,6	48	2,2	8	ATB	9.250	
B-56699	165	20	1,4	28	2	15	ATB	9.250	
B-56708	165	20	1,25	48	1,85	8	ATB	9.250	
B-56714	165	20	1,4	56	2	-3	TCG	9.250	
B-56720	165	20	1,4	60	2	5	HI-ATB	9.250	
B-56736	165	20	1,4	60	2	5	TCG	9.250	
B-56742	165	20	1,4	48	2	5	ATAF	9.250	
B-57320	165	20	1	56	1,45	23	ATAF	9.250	
B-09313	185	15,88	1,6	24	2,2	20	ATB	8.250	
B-19015	190	30	1,6	24	2,2	20	ATAF	8.250	



## Specialized - žagini listi za les z grčami in žebli

Žagini listi z ojačano konico ali "Globokim zobom" so izjemno odporni in vzdržljivi. Še posebej primerni so za rezanje lesa z grčami, ovire pa ne predstavljajo niti žebli, ki jih lahko enostavno prerežete, ne da bi pri tem poškodovali zobe. Možnost uporabe pri rušenju ali za rezanje uporabljenega lesa. Visoka uporabnost in daljši servisni intervali.



Koda	Žagin list (Ø) (mm)	Luknja žaginega lista (Ø) (mm)	Debelina rezila (mm)	Število zob	Debelina reza (mm)	Rezalni kot (°)	Oblika zob	Največje število obratov (min <sup>-1</sup> )	Cena z DDV
B-09329	165	20	1,3	16	2	23	ATB	9.250	
B-09391	165	20	1,3	24	2	23	ATB	9.250	
B-09472	165	20	1,3	40	2	18	ATB	9.250	
B-09335	185	15,88	1,3	16	2	25	ATB	8.250	
B-09341	185	30	1,3	16	2	25	ATB	8.250	
B-09400	185	15,88	1,3	24	2	23	ATB	8.250	
B-09416	185	30	1,3	20	2	25	ATB	8.250	
B-09494	185	30	1,3	40	2	25	ATB	8.250	
B-09357	190	30	1,3	16	2	25	ATB	8.040	
B-09422	190	30	1,3	24	2	25	ATB	8.040	
B-09503	190	30	1,3	40	2	25	ATB	8.040	
B-09363	210	30	1,4	18	1,9	25	ATB	7.300	
B-09438	210	30	1,4	24	1,9	23	ATB	7.300	
B-27246	210	30	1,8	40	2,8	20	ATB	7.300	
B-09379	235	30	1,6	20	2,3	25	ATB	6.500	
B-09444	235	30	1,6	24	2,3	23	ATB	6.500	
B-09519	235	30	1,6	48	2,3	18	ATB	6.500	
B-40624	260	30	1,8	32	2,3	5	ATAF	5.870	
B-40630	260	30	1,8	64	2,3	5	ATAF	5.870	
B-09450	270	30	1,8	24	2,6	23	ATB	5.650	
B-09525	270	30	1,8	40	2,6	18	ATB	5.650	
B-09531	270	30	1,8	60	2,6	18	ATB	5.650	
B-09385	355	30	2,2	24	3	23	ATB	4.300	
B-09466	355	30	2,2	40	3	23	ATB	4.300	
B-09547	355	30	2,2	60	3	18	ATB	4.300	





## Specialized - žagini listi za nerjavno jeklo

Posebej izdelani žagini listi za rezanje nerjavnega jekla imajo daljšo življenjsko dobo.



Koda	Žagin list (Ø) (mm)	Luknja žaginega lista (Ø) (mm)	Debelina rezila (mm)	Število zob	Debelina reza (mm)	Rezalni kot (°)	Oblika zob	Največje število obratov (min <sup>-1</sup> )	Cena z DDV
B-23086	136	20	1	56	1,1	0	SMTCCG	4.500	
B-47014	150	20	1	60	1,1	0	SMTCCG	4.680	
B-07870	185	30	1,8	40	1,8	-3	SMTCCG	5.160	
B-23123	305	25,4	1,7	100	2	-3	SMTCCG	2.000	



## Specialized - žagini listi za kovino

Na novo razviti žagini listi za rezanje kovin omogočajo še hitrejšo in bolj gladko rezanje kot do sedaj. Nova sestava kovinskega karbida v kombinaciji z edinstveno zasnovano zob zagotavlja izjemno odpornost proti udarcem. Makita žagini listi za rezanje kovine zdržijo tudi do 30x dlje od običajnih žaginskih listov za kovino.



Koda	Žagin list (Ø) (mm)	Luknja žaginega lista (Ø) (mm)	Debelina rezila (mm)	Število zob	Debelina reza (mm)	Rezalni kot (°)	Oblika zob	Največje število obratov (min <sup>-1</sup> )	Cena z DDV
B-10615	136	20	1,2	30	1,5	0	MTCG	4.500	
B-21973	136	20	1,1	50	1,4	-15	ATB	4.500	
B-69266	136	20	0,95	30	1,1	0	SMTCCG	4.500	
B-69272	136	20	0,95	45	1,1	0	SMTCCG	4.500	
B-46296	150	20	1,2	32	1,5	0	MTCG	4.680	
B-47167	150	20	1,1	52	1,4	-15	ATB	4.680	
B-69294	150	20	0,95	48	1,1	0	SMTCCG	4.680	
E-02923	150	20	0,95	32	1,1	0	TCG	4.680	
B-09743	185	30	1,5	36	1,9	0	ATB	5.800	
B-09759	185	30	1,6	38	2	0	MTCG	5.800	
B-09771	185	30	1,3	70	1,7	-10	FTG	5.800	
B-09787	185	30	1,6	48	2	0	MTCG	5.800	
B-23329	185	30	1,5	48	1,9	0	SMTCCG	5.800	
B-23363	185	30	1,5	56	1,8	0	SMTCCG	5.800	
B-31669	185	30	1,3	64	1,6	0	SMTCCG	5.800	
E-12843	185	30	1,2	60	1,4	0	SMTCCG	/	
E-12859	185	30	1,2	45	1,4	0	SMTCCG	/	
B-09765	305	25,4	1,7	60	2,1	0	TCG	2.000	
B-09793	305	25,4	2,3	78	2,3	-5	MTCG	2.000	
B-34132	305	25,4	2	60	2,4	0	TCG	2.000	
E-12049	305	25,4	1,75	63	2	-2	SMTCCG	/	

 Akumulator  
in  
polnilniki

 Pribor za  
akumulator  
orsko  
orodje

 Akumulator  
orske  
svetilke  
in pribor

 Pribor za  
laserske  
merilnike

 Pribor za  
rušenje  
in vrtanje

 Pribor za  
vrtanje

 Kronske  
žage

 Pribor za  
vijačenje

 Pribor za  
rezanje  
in  
brušenje

 Pribor za  
poliranje  
in  
brušenje

 Pribor za  
rezkanje  
in  
oblanje

 Pribor za  
multifunk  
orodje

 Pribor za  
žaganje

 Pribor za  
žebjalnike  
in  
spenjalnike

 Pribor za  
fene

 Pribor za  
sesanje

 Pribor  
orodja za  
uporabo  
na prostem

 Pribor za  
prijem  
orodja in  
zaščitna  
oprema

 Kovčki in  
torbe za  
orodje

 Ročno  
orodje

Razno

 Pribor za  
mešanje

## Specialized - žagini listi za aluminij



Žagini listi za stabilne prenosne in kotne žage z izjemno rezalno zmogljivostjo pri rezanju aluminija, svinca, medenine, bronca ali drugih neželeznih materialov. List za natančno in ravno namestitev omogoča natančnejše rezanje. Izjemna kvaliteta rezanja v neželezne materiale. Na zobeh morate redno namestiti vosek za žagine liste, saj s tem preprečujete nabiranje žaganja in odrezkov. Izjemno tanki in dobro uravnoteženi jekleni žagini listi omogočajo natančno delo. Odlična rezalna zmogljivost pri rezanju mehkih kovin zahvaljujoč posebnemu profilu zob.



Koda	Žagin list (Ø) (mm)	Luknja žaginega lista (Ø) (mm)	Debelina rezila (mm)	Število zob	Debelina reza (mm)	Rezalni kot (°)	Oblika zob	Največje število obratov (min <sup>-1</sup> )	Cena z DDV
B-40294	136	20	1,0	50	1,6	0	ATB	4.500	
B-47020	150	20	1	52	1,6	0	ATB	4.680	
B-09553	160	20	1,8	60	2,4	0	TCG	9.540	
B-09569	160	30	1,8	60	2,4	0	TCG	9.540	
B-09307	165	20	1,7	56	2,4	-3	TCG	9.250	
B-09575	180	30	1,8	60	2,4	0	TCG	8.480	
B-09581	185	15,88	1,8	60	2,4	0	TCG	8.250	
B-09597	190	30	1,8	60	2,4	0	TCG	8.040	
B-09612	190	20	1,4	60	2	-5	TCG	8.040	
B-09690	200	30	2,2	64	2,8	0	TCG	7.630	
B-12435	210	30	1,8	60	2,4	0	TCG	/	
B-09628	216	30	1,6	64	2,2	-5	TCG	7.070	
B-09606	235	30	1,8	80	2,4	0	TCG	6.500	
B-09634	250	30	1,8	80	2,4	-5	TCG	6.110	
B-09640	250	30	1,8	100	2,4	-5	TCG	6.110	
B-09709	250	30	2,2	80	2,8	0	TCG	6.110	
B-09656	260	30	1,8	80	2,4	-5	TCG	5.870	
B-09662	260	30	1,8	100	2,4	-5	TCG	5.870	
B-09715	260	30	2,2	80	2,8	0	TCG	5.870	
E-06317	260	30	1,5	81	1,85	-3	SMTCCG	5.870	
B-09721	300	30	2,2	80	2,8	0	TCG	5.090	
B-09678	305	30	1,8	80	2,4	-5	TCG	5.000	
B-09684	305	30	1,8	100	2,4	-5	TCG	5.000	
B-09737	350	30	2,6	100	3,2	0	TCG	4.360	



## Žagini listi za aluminij

Koda	Žagin list (Ø) (mm)	Luknja žaginega lista (Ø) (mm)	Debelina rezila (mm)	Število zob	Debelina reza (mm)	Rezalni kot (°)	Oblika zob	Največje število obratov (min <sup>-1</sup> )	Cena z DDV
D-72970	190	30 (20)	1,4	60	2,2	5	TCG	8.040	
D-72986	210	30	1,6	60	2,4	5	TCG	7.170	
D-72992	235	30	1,6	80	2,4	5	TCG	6.500	
D-73003	260	30	1,8	70	2,8	5	TCG	5.870	
D-73019	305	30	2,0	80	2,8	5	TCG	5.000	
D-73025	305	30	2,0	100	2,8	5	TCG	5.000	



## Specialized - žagini listi za gradbeništvo

Žagini listi za rezanje v gradbeništvu so zasnovani za delo na terenu in so dovolj močni za rezanje tramov, vezanih plošč in gradbenih elementov. Ko je hitrost bolj pomembna od pregledovanja lesa za žeblice, so žagini listi za delo v gradbeništvu prava izbira. Za ročne krožne žage. Posebej razviti za groba dela v gradbeništvu. Žagin list ima dobra rezila in močno ter robustno zasnovo.



Koda	Žagin list (Ø) (mm)	Luknja žaginega lista (Ø) (mm)	Debelina rezila (mm)	Število zob	Debelina reza (mm)	Rezalni kot (°)	Oblika zob	Največje število obratov (min <sup>-1</sup> )	Cena z DDV
B-13683	190	30	1,6	12	2,6	20	FTG	8.040	
B-13699	235	30	1,8	16	2,8	20	FTG	6.500	



## Specialized - žagini listi za sendvič panel

Žagini listi so izdelani za rezanje kovinskih kompozitnih materialov bolj znanih pod imenom sendvič paneli – dve tanki kovinski plošči obdajata izolativni material. Zasnovani so tako, da naredijo gladek in čist rez ter ne puščajo hrapave površine. Pri tem se ustvari le malo toplote, kar ščiti izolativno jedro sendvič panela pred poškodbami.



Koda	Žagin list (Ø) (mm)	Luknja žaginega lista (Ø) (mm)	Debelina rezila (mm)	Število zob	Debelina reza (mm)	Rezalni kot (°)	Oblika zob	Največje število obratov (min <sup>-1</sup> )	Cena z DDV
B-63133	165	20	1,4	42	1,75	0	SMTCC	9250	
B-17675	235	30	1,8	50	2,2	0	SMTCC	6.500	
B-17681	270	30	2	60	2,4	0	SMTCC	5.650	
B-17697	355	30	2,2	80	2,6	0	SMTCC	4.300	



## Specialized - žagini listi za laminat

Za stabilne in kotne žage. Posebej razviti za rezanje laminata. Omogočajo tiho rezanje in izdelavo gladkih rezov.



Koda	Žagin list (Ø) (mm)	Luknja žaginega lista (Ø) (mm)	Debelina rezila (mm)	Število zob	Debelina reza (mm)	Rezalni kot (°)	Oblika zob	Največje število obratov (min <sup>-1</sup> )	Cena z DDV
B-29446	136	20	1,0	48	1,4	10	ATAF	4.500	
B-53198	165	20	1,0	44	1,45	23	ATAFR	4.770	
B-57364	165	20	1,0	56	1,45	23	ATAFR	9.250	
B-29480	250	30	1,8	84	2,5	5	TCG	6.110	
B-29496	260	30	1,8	84	2,5	5	TCG	5.870	
B-29505	305	30	1,8	96	2,5	5	TCG	5.000	

 Akumulat  
orji in  
poinliniki

 Pribor za  
akumulat  
orsko  
orodje

 Akumulat  
orske  
svetilke  
in pribor

 Pribor za  
lasarske  
merilnike

 Pribor za  
rušenje  
in vrtanje

 Pribor za  
vrtanje

 Kronske  
žage

 Pribor za  
vijačenje

 Pribor za  
rezanje  
in  
brušenje

 Pribor za  
poliranje  
in  
brušenje

 Pribor za  
režkanje  
in  
oblanje

 Pribor za  
multifunk  
ciljsko  
orodje

 Pribor za  
žaganje

 Pribor za  
žebjalnike  
in  
spenjalnike

 Pribor za  
fene

 Pribor za  
sesanje

 Pribor  
orodja za  
uporabo  
na prostem

 Pribor za  
ročno  
orodje in  
zaščitna  
oprema

 Kovčki in  
torbe za  
orodje

 Ročno  
orodje

Razno

 Pribor za  
mešanje



## TCT žagini listi za sendvič plošče s cementnim vezivom

TCT žagin list za sendvič plošče s cementnim vezivom in ojačitvijo iz steklenih vlaken



Koda	Žagin list (Ø) (mm)	Luknja žaginega lista (Ø) (mm)	Debelina rezila (mm)	Število zob	Debelina reza (mm)	Rezalni kot (°)	Oblika zob	Največje število obratov (min <sup>-1</sup> )	Cena z DDV
B-22997	165	20	1,6	4	2,3	12	FTG	9.250	
B-23014	260	30	1,8	6	2,5	8	FTG	5.870	



## Specialized - 2712



Koda	Žagin list (Ø) (mm)	Luknja žaginega lista (Ø) (mm)	Debelina rezila (mm)	Število zob	Debelina reza (mm)	Rezalni kot (°)	Oblika zob	Največje število obratov (min <sup>-1</sup> )	Cena z DDV
B-46171	315	30	2,0	28	2,8	20	ATB	4.850	
B-46187	315	30	2,0	48	2,8	10	ATB	4.850	
B-46193	315	30	2,0	60	2,8	10	ATB	4.850	
JM27170001	315	30	2	40	2,8	16		4.850	



## Večnamenski žagini listi za krožne žage

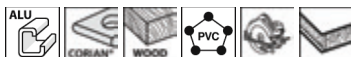

Koda	Žagin list (Ø) (mm)	Luknja žaginega lista (Ø) (mm)	Debelina rezila (mm)	Število zob	Debelina reza (mm)	Rezalni kot (°)	Oblika zob	Največje število obratov (min <sup>-1</sup> )	Cena z DDV
D-65567	160	20	1,4	60	2,2	5	TCG	9.450	
D-65573	165	20	1,4	60	2,2	5	TCG	9.250	
D-65589	185	30	1,4	60	2,2	5	TCG	8.300	
D-65595	190	30	1,4	60	2,2	5	TCG	8.040	
D-65604	210	30	1,6	60	2,4	5	TCG	7.170	
D-65632	235	30/25,4	1,6	60	2,4	5	TCG	6.500	



## Večnamenski žagini listi za stabilne in kotne žage

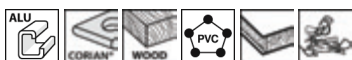

Koda	Žagin list (Ø) (mm)	Luknja žaginega lista (Ø) (mm)	Debelina rezila (mm)	Število zob	Debelina reza (mm)	Rezalni kot (°)	Oblika zob	Največje število obratov (min <sup>-1</sup> )	Cena z DDV
D-65610	216	30	1.6	60	2.4	5	TCG	7.070	
D-65626	216	30	1.6	80	2.4	5	TCG	7.070	
D-65648	260	30	1.8	80	2.6	5	TCG	5.870	
D-65654	260	30	1.8	100	2.6	5	TCG	5.870	
D-65660	260	30	1.8	120	2.6	5	TCG	5.870	
D-65676	305	30	2	80	2.8	5	TCG	5.000	
D-65682	305	30	2	100	2.8	5	TCG	5.000	
D-65698	305	30	2	120	2.8	5	TCG	5.000	
D-65707	355	30	2,2	100	3	5	TCG	4.300	

## EFFICUT - žagini listi za akumulatorske žage

Nova oblika poveča učinkovitost odvajanja odpadkov, omogoča 2,5× hitrejše rezanje in poveča količino dela z enim polnjenjem. Primerni so za akumulatorske ročne in stabilne kotne žage.



Koda	Žagin list (Ø) (mm)	Luknja žaginega lista (Ø) (mm)	Debelina rezila (mm)	Število zob	Debelina reza (mm)	Rezalni kot (°)	Oblika zob	Največje število obratov (min <sup>-1</sup> )	Cena z DDV
B-62979	165	20	1,0	25	1,4	23	ATAF	9.250	
B-64185	190	30	1,0	24	1,45	23	ATAF	8.040	
B-67234	260	30	1,65	60	2,15	10	ATAFR	5.870	
B-67240	260	30	1,65	80	2,15	10	ATAFR	5.870	
B-67256	305	30	1,65	60	2,15	10	ATAFR	5.000	
B-67262	305	30	1,65	80	2,15	10	ATAFR	5.000	
B-67278	305	30	1,65	100	2,15	10	ATAFR	5.000	
B-69858	165	20	1,35	60	1,85	10	ATBR	9.250	
E-06971	216	30	1,5	45	2	10	ATBR	7.070	
E-07696	260	30	1,5	24	2,15	23	ATAFR	5.870	
E-08676	185	30	1,0	24	1,45	23	ATAFR	8.250	
E-11140	190	20	1,35	25	1,85	10	ATBR	8.040	
E-11156	190	20	1,35	45	1,85	10	ATBR	8.040	
E-11162	190	20	1,35	60	1,85	10	ATBR	8.040	

 Akumulator  
orji in  
pnilniki

 Pribor za  
akumulator  
orsko  
orodje

 Akumulator  
orske  
svetilke  
in pribor

 Pribor za  
lasarske  
merilnike

 Pribor za  
rušenje  
in vrtanje

 Pribor za  
vrtanje

 Kronske  
žage

 Pribor za  
vijačenje

 Pribor za  
rezanje  
in  
brušenje

 Pribor za  
poliranje  
in  
brušenje

 Pribor za  
rezkanje  
in  
oblanje

 Pribor za  
multifunk  
ciljsko  
orodje

 Pribor za  
žaganje

 Pribor za  
žebjalnike  
in  
spenjalnike

 Pribor za  
fene

 Pribor za  
sesanje

 Pribor  
orodja za  
uporabo  
na prostem

 Pribor za  
ročno  
zaščitna  
oprema

 Kovčki in  
torbe za  
orodje

 Ročno  
orodje

Razno

 Pribor za  
mešanje





## Žagini listi za kompozitne materiale

Koda	Žagin list (Ø) (mm)	Luknja žaginega lista (Ø) (mm)	Debelina rezila (mm)	Število zob	Debelina reza (mm)	Rezalni kot (°)	Oblika zob	Cena z DDV
E-12142	165	20	1,0	24	1,5	15	ATAFR	
E-12158	165	20	1,0	40	1,5	15	ATAFR	
E-12164	185	30	1,0	24	1,5	15	ATAFR	
E-12170	185	30	1,0	40	1,5	15	ATAFR	
E-12186	190	20	1,35	50	1,85	8	ATAFR	
E-12192	216	30	1,5	60	2,0	8	ATAFR	
E-12201	260	30	1,65	75	2,15	8	ATAFR	



## Reducirni obroči za TCT žagine liste

Koda	Zunanji premer (mm)	Notranji premer (mm)	Debelina rezila (mm)	Cena z DDV
B-20987	20	15,88	1,2	
B-20993	20	15,88	1,8	
B-21004	30	15,88	1,2	
B-21010	30	15,88	1,8	
B-21026	30	20	1,2	
B-21032	30	20	1,4	
B-21048	30	20	1,8	
B-21060	30	25,4	1,4	
B-21076	30	25,4	2,2	

Akumulat orji in polnilniki  
 Pribor za akumulat orsko orodje  
 Akumulat orske svetilke in pribor  
 Pribor za lasarske mlinčke  
 Pribor za rušenje in vrtanje  
 Pribor za vrtanje  
 Kronske žage  
 Pribor za vijčenje  
 Pribor za rezanje in brušenje  
 Pribor za poliranje in brušenje  
 Pribor za rezkanje in oblanje  
 Pribor za multitank cisko orodje  
 Pribor za žaganje  
 Pribor za žebjalnike in spenjalnike  
 Pribor za fene  
 Pribor za sesanje  
 Pribor orodja za uporabo na prostem  
 Pribor za nosenje orodja in zaščitna oprema  
 Kovčki in torbe za orodje  
 Ročno orodje  
 Razno  
 Pribor za mešanje

# ŽAGINI LISTI ZA VBODNE ŽAGE

## VRSTA OZOBJA

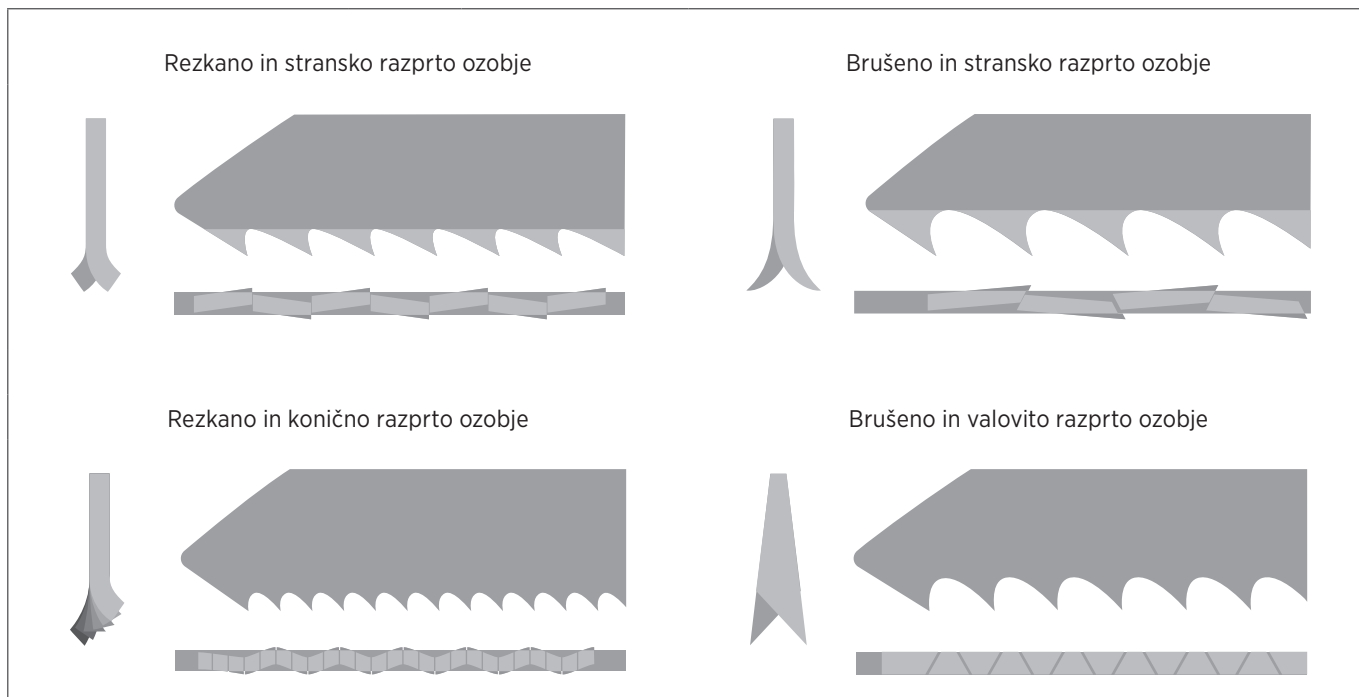

## PRIMERJAVA OBLIKE IN RAZPRTOSTI

REZKANO OZOBJE	BRUŠENO OZOBJE
<p>Zelo ostri Natančen, čisti rez Mehki do srednje trdi materiali</p> 	<p>Univerzalni rez Mehki do trdi materiali Dolga življenjska doba rezila</p> 

STRANSKA RAZPRTOST	VALOVITA RAZPRTOST	KONIČNA RAZPRTOST
<p>Vsak posamezen zob je izmenično upognjen v levo in desno. Primer: desno, levo, naravnost, itd.</p> 	<p>Zobje imajo obliko valov.</p> 	<p>Rezilo se razširi proti vrhu rezila (stožčast).</p> 

## MATERIALI

**HCS (hitrorezno jeklo)** za rezanje mehkejših materialov, kot so mehek les ali mehke umetne mase.

**HSS (visoko učinkovito hitrorezno jeklo)** za rezanje trših materialov, kot so kovine.

**BIM (Bi-metal, HCS telo in HSS zob)** za rezanje trdih materialov, kot so trd les, kovina, trde umetne mase.

**TC (Volframov karbid)** za rezanje steklenih vlaken, armirane plastike, vlaknenih ali mavčnih plošč, vezanih s cementom.

## Vbodne žage

## HCS žagini listi za les, grobi rez



	Koda	Vrsta rezila	Delovna dolžina (mm)	Število zob na colo	Mehak / trd les (mm)	Umetne mase (mm)	Enota (kos/set)	Cena z DDV
	A-85656	B-13	70	8	4-65	4-65	5/1	
	A-85662	B-14	51	18	2-35	2-35	5/1	
	A-85678	B-15	50	12	3-35	3-35	5/1	
	A-85709	B-18	44	14	2-35	2-35	5/1	
	A-85793	BR-13	64	9	5-65		5/1	
	D-34877	B-13	74	8	4-50		5/1	

## HCS žagini listi za les, čisti rez



	Koda	Vrsta rezila	Delovna dolžina (mm)	Število zob na colo	Iverne plošče (mm)	Mehak / trd les (mm)	Umetne mase (mm)	Enota (kos/set)	Cena z DDV
	A-85628	B-10	76	9	3-65	3-65	3-65	5/1	
	A-85634	B-11	73	9	3-60	3-60	3-60	5/1	
	A-85640	B-12	74	6	5-65	5-65	5-65	5/1	
	A-85715	B-19	63	12	3-50	3-50	3-50	5/1	
	A-86290	L-1	101	6	5-90	5-90	5-90	5/1	
	D-72718	B-10	74	9	4-50	4-50	4-50	5/1	

## HCS žagini listi za les, hitri rez



	Koda	Vrsta rezila	Delovna dolžina (mm)	Število zob na colo	Mehak / trd les (mm)	Umetne mase (mm)	Enota (kos/set)	Cena z DDV
	A-85232	B-8	75	8	4-65	4-65	5/1	
	A-85684	B-16	75	6	5-65	5-65	5/1	
	A-85690	B-17	71	6	5-60	5-60	5/1	
	A-86309	L-2	101	6	5-90	5-90	5/1	
	A-86315	L-10	151	6	5-135	5-135	5/1	
	A-86577	58	75	8	4-65	4-65	5/1	
	D-34883	B-16	74	6	4-50	4-50	5/1	
	D-34899	/	74	6	4-50	4-50	5/1	

# Pribor za žaganje

## HSS žagini listi za kovino, univerzalen rez



Koda	Vrsta rezila	Delovna dolžina (mm)	Število zob na colo	Aluminij (mm)	Umetne mase (mm)	Nerjavno jeklo (mm)	Kovina (mm)	Enota (kos/set)	Cena z DDV	
A-85721	B-21	73	12	1-10	3-60			5/1		
A-85737	B-22	52	24	1-3	1-6	1-3	1-3	5/1		
A-85743	B-23	51	14	2-6	3-35	2-6	2-6	5/1		
A-85759	B-24	52	32	1-2	1-3	0,5-2	0,5-2	5/1		
A-85771	B-26	71	9	3-10	3-60	3-10	3-10	5/1		
A-85787	B-27	52	24	1-3	1-6	1-3	1-3	5/1		
B-04961	B-30	50	24	1-3	1-6	1-3	1-3	5/1		
D-34908	B-22	51	21	1-3			1-3	5/1		

## BiM žagini listi za laminat



Koda	Vrsta rezila	Delovna dolžina (mm)	Število zob na colo	Laminat (mm)	Zavito rezanje	Gladek rez	Enota (kos/set)	Cena z DDV	
B-10970	B-53	59	15	1,5-15		•	5/1		
B-10986	B-54	59	18	1,5-15	•	•	5/1		
B-31887	B-55	77	15	2-30		•	5/1		

## HM žagini listi za steklena vlakna



Koda	Delovna dolžina (mm)	Razmak med zobmi (mm)	Steklena vlakna (mm)	Zavito rezanje	Debeli materiali	Primerno za	Enota (kos/set)	Material rezila	Cena z DDV	
P-38766	75	4,2		•	•	steklena vlakna, ojačane plastike, MDF	3/1	HM		
P-38788	54	/	1-15	•		rezanje nekovnih, steklenih vlaken, PVC	3/1			

## Specializirani žagini listi za različne materijale





Koda	Vrsta rezila	Material rezila	Delovna dolžina (mm)	Število zob na colo	Primerno za	Enota (kos/set)	Cena z DDV	
A-80416	B-K	HCS	75		papir, plutovina, guma, usnje	5/1		
A-85765	B-25	HSS	74	9	trdi les, les z žebliki, trše plastike, kovina, barvne kovine	5/1		
B-06890	B-60	HM	75	6	mavčne plošče 5 -50 mm, FRP/ plastika 5 -20 mm	3/1		

Nadaljevanje...

- Akumulat orji in polnilniki
- Pribor za akumulat orsko orodje
- Akumulat orske svetilke in pribor
- Pribor za lasarske mlinčke
- Pribor za rušenje in vrtanje
- Pribor za vrtanje
- Kronske žage
- Pribor za vijačenje
- Pribor za rezanje in brušenje
- Pribor za poliranje in brušenje
- Pribor za rezanje in oblanje
- Pribor za multitfunkcijsko orodje
- Pribor za žaganje
- Pribor za žebličke in spenjalnike
- Pribor za fene
- Pribor za sesanje
- Pribor orodja za uporabo na prostem
- Pribor za čiščenje orodja in zaščitna oprema
- Kovčki in torbe za orodje
- Ročno orodje
- Razno
- Pribor za mešanje

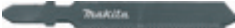

# Pribor za žaganje

	Koda	Vrsta rezila	Material rezila	Delovna dolžina (mm)	Število zob na colo	Primerno za	Enota (kos/set)	Cena z DDV
	B-06909	B-61	HM	105	6	mavčne plošče 5-80 mm, FRP/plastika 5-50 mm	3/1	
	P-05929	/	HM	50	24	kovine, nerjavno jeklo	1	
	P-47204	/	Bi-Metal	105	24	obloge 80mm, sendvič materiali, lepenke, kovine	5/1	
	P-49622	/	Bi-Metal	75	10	les z žebli, kovine	5/1	
	P-49644	/	Bi-Metal	155	24	debele obloge, lepenke	5/1	

## Žagini listi Super Express, super hitri rez



Revolucionarna rezalna moč. "Super Express" rezila imajo progresivno zasnovano zob, ki lahko enostavno zarezujejo v tanke in debele obdelovance. Makita Super Express rezila so ozka, kar omogoča izjemno hitro rezanje in visokokvalitetne reze. Rezila so idealna za akumulatorske žage, saj zaradi ozke oblike porabijo manj energije, kar omogoča več opravljenega dela z enim akumulatorjem.



	Koda	Vrsta rezila	Material rezila	Delovna dolžina (mm)	Število zob na colo	Aluminij (mm)	Umetne mase (mm)	Nerjavno jeklo (mm)	Enota (kos/set)	Cena z DDV
	B-06460	B-50	HCS	73	8,5-10,6		5-50		5/1	
	B-06476	B-51	HSS	73	9,8-18,1	1-10	1-3	1-3	5/1	
	B-06482	B-52	HSS	73	5,5-9,8	3-35	3-35	3-8	5/1	

## Seti različnih žaginskih listov



	Koda	Naziv	Vrsta rezila	Material rezila	Celotna dolžina (mm)	Enota (kos/set)	Cena z DDV
	A-86898	5-delni set žaginskih listov za vbojno žago	B-13, B-16, B-22, B-23, B-10S	HCS, HSS		5/1	
	B-06292	3-delni set Express žaginskih listov za vbojno žago	B-50, B-51, B-52	HSS		3/1	
	B-44426	Žagin list za vbojno žago (različni)-set B	4x B-50, 2x (B-51, B-52, B-53)	HCS, HSS	2x 82 mm, 8x 100 mm	10/1	



# Pribor za žaganje

## Seti žaginih listov - 100 kos









Koda	Vrsta rezila	Material rezila	Delovna dolžina (mm)	Razmak med zobmi (mm)	Število zob na colo	Primerno za	Enota (kos/set)	Cena z DDV
B-07674	B-10	HCS	76	2,9	9	les	100/1	
B-07680	B-11	HCS	73	2,8	9	les	100/1	
B-07696	B-12	HCS	74	4,2	6	les	100/1	
B-07705	B-13	HCS	70	3,2	8	les	100/1	
B-07727	B-18	HCS	44	1,8	14	les	100/1	
B-07733	B-22	HSS	52	1,1	24	kovina	100/1	
B-07749	B-23	HSS	51	1,8	14	kovina	100/1	
B-07755	B-25	HSS	74	2,8	9	les	100/1	
B-07761	B-29	HCS	44	1,6	77	les	100/1	
B-07777	BR-13	HCS	70	2,8	90	les	100/1	
B-07783	No.1	HSS	61	1,1	24	kovina	100/1	
B-07799	No.2	HSS	60	1,8	14	les	100/1	

[Nadaljevanje...](#)







- Akumulat orji in polnilniki
- Pribor za akumulat orsko orodje
- Akumulat orske svetilke in pribor
- Pribor za lasarske mešalnike
- Pribor za rušenje in vrtanje
- Pribor za vrtanje
- Kronske žage
- Pribor za vijačenje
- Pribor za rezanje in brušenje
- Pribor za poliranje in brušenje
- Pribor za rezkanje in oblanje
- Pribor za multitfunkcijsko orodje
- Pribor za žaganje**
- Pribor za žebjalnike in spenjalnike
- Pribor za fene
- Pribor za sesanje
- Pribor orodja za uporabo na prostem
- Pribor za klesanje in zaščita oprema
- Kovčki in torbe za orodje
- Ročno orodje
- Razno
- Pribor za mešanje

# Pribor za žaganje

Akumulat orji in polnilniki  
 Pribor za akumulat orsko orodje  
 Akumulat orske svetilke in pribor  
 Pribor za lasarske mliničke  
 Pribor za rušenje in vrтанje  
 Pribor za vrтанje  
 Kronske žage  
 Pribor za vijačenje  
 Pribor za rezanje in brušenje  
 Pribor za poliranje in brušenje  
 Pribor za rezkanje in oblanje  
 Pribor za multitank cijsko orodje  
 Pribor za žaganje  
 Pribor za žebjalnice in spenjalnice  
 Pribor za fene  
 Pribor za sesanje  
 Pribor orodja za uporabo na prostem  
 Pribor za nosenje orodja in zaščitna oprema  
 Kovčki in torbe za orodje  
 Ročno orodje  
 Razno  
 Pribor za mešanje

	Koda	Vrsta rezila	Material rezila	Delovna dolžina (mm)	Razmak med zobmi (mm)	Število zob na colo	Primerno za	Enota (kos/set)	Cena z DDV
	B-07808	No.3	HCS	59	2,8	9	les	100/1	
	B-07814	No.8	HCS	60	3,2	8	les	100/1	
	B-07820	Nr.10	HCS	60	2,9	9	les	100/1	
	B-07836	No.51	HSS	66	1,1	24	kovina	100/1	
	B-07842	No.58	HCS	75	2,9	9	les	100/1	
	B-07858	No.59	HCS	75	3,2	8	les	100/1	





## Pribor za vboodne žage

	Koda	Naziv	Za model	Cena z DDV
	123030-5	Krožno vodilo	4300BA, 4300BV	
	164113-2	Vzporedni prislon	4300BV, JV2000	
	192557-6	Zaščita proti cepljenju lesa	DJV184	
	192561-5	Krožno vodilo	4304T, 4331, 4333	
	192732-4	Vzporedni prislon in krožno vodilo	JV100D, JV101D, JV102D, JV103D, JV143D, JV183D, 4326/M, 4327/M, 4328, 4329, JV0600, DJV184	
	193516-3	Vzporedni prislon in krožno vodilo	DJV141, DJV142, DJV180, DJV181, DJV182, 4350T/CT/FCT, 4351T/CT/FCT	

[Nadaljevanje...](#)

# Pribor za žaganje

239

Koda	Naziv	Za model	Cena z DDV	
197252-3	Adapter za vodilo A, B in JV za namestitvev na vodilno letev	DHS630, DHS710, HS7101, HS6101, 4350CT, 4350FCT, 4351CT, 4351FCT, DJV180, DJV181, DJV182		
415524-7	Zaščita proti cepljenju lesa	4329, 4340CT, 4340FCT, 4341CT, 4341FCT, 4350CT, 4350FCT, 4351CT, 4351FCT, DJV180, DJV181, DJV182, JV103		
416477-3	Zaščita proti cepljenju lesa	4323		
417852-6	Zaščitni pokrov	4350CT, 4350FCT, 4351CT, 4351FCT, DJV180, DJV181, DJV182, DJV184		
458191-5	Zaščitni protiprašni pokrov	DJV184		

Akumulat orji in polnilniki

Pribor za akumulat orsko orodje

Akumulat orske svetilke in pribor

Pribor za laserske merilnike

Pribor za rušenje in vrtanje

Pribor za vrtanje









Kronske žage

Pribor za vijačenje

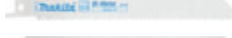
## Sabljaste žage

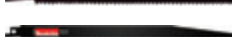
### Žagini listi za les



Koda	Material rezila	Debelina rezila (mm)	Celotna dolžina (mm)	Število zob na colo	Mehak / trd les (mm)	Umetne mase (mm)	Les z žebli (mm)	Enota (kos/set)	Cena z DDV	
B-03030	HCS	1,25	300	6	5-250	135-280		5/1		
B-05175	Bi-Metal	1,25	152	6	50-100	5-135	10-100	5/1		
B-31843	Bi-Metal	0,9	152	10	5-100		5-100	5/1		
B-31859	Bi-Metal	0,9	225	10	5-175		5-175	5/1		
P-04999	HSS	0,9	150	4	8-100	0-100		5/1		
P-05000	HSS	0,9	150	10	5-100			5/1		
P-05016	HCS	0,9	300	6	6-250	6-250		5/1		
P-05022	HSS	0,9	150	6	6-100	6-100		5/1		
P-05072	HSS	1,27	300	4-6,5	3-250			5/1		

Pribor za rezanje in brušenje

Pribor za poliranje in brušenje

Pribor za rezkanje in oblanje

Pribor za multitank orodje

Pribor za žabljanske spenjalnike

Pribor za fene

Pribor za sesanje

Pribor orodja za uporabo na prostem

Pribor za ročno orodje in zaščitna oprema

Kovčki in torbe za orodje

Ročno orodje

Razno

Pribor za mešanje

# Pribor za žaganje

## Žagini listi za kovino



	Koda	Material rezila	Celotna dolžina (mm)	Debelina rezila (mm)	Število zob na colo	Aluminij (mm)	Kovina (mm)	Nerjavno jeklo (mm)	Enota (kos/set)	Cena z DDV
	B-05169	Bi-Metal	152	0,9	18	1,5-3	1,5-4		5/1	
	B-05169-2	Bi-Metal	152	0,9	18	1,5-3	1,5-4		2/1	
	B-05169-25	Bi-Metal	152	0,9	18	1,5-3	1,5-4		25/1	
	B-16776	Bi-Metal	225	0,9	14		3-8		5/1	
	B-16776-2	Bi-Metal	225	0,9	14		3-8		2/1	
	B-16776-25	Bi-Metal	225	0,9	14		3-8		25/1	
	B-16782-25	Bi-Metal	228	0,9	18		1,5-4		25/1	
	B-16841-25	Bi-Metal	152	0,9	14		3-8		25/1	
	B-16857	Bi-Metal	305	0,9	10-14	5-20	5-20		5/1	
	B-16857-2	Bi-Metal	305	0,9	10-14	5-320	5-20		2/1	
	B-43175	Bi-Metal	225	1,1	14-18		0,7-3		5/1	
	B-55815	Bi-Metal	152	1,1	14-18		3-8		5/1	
	B-55821	Bi-Metal	228	1,1	14-19		3-8		5/1	
	B-55837	Bi-Metal	305	1,1	14-20		3-8		5/1	
	P-04874	Bi-Metal	100	0,9	18		1,5-2,5	1,5-3	5/1	
	P-04880	Bi-Metal	150	0,9	18		1,5-2,5	1,5-3	5/1	
	P-04896	Bi-Metal	100	0,9	24	1-6	1,2-2	1,5-3	5/1	
	P-04905	Bi-Metal	150	0,9	24	1,5-4	1,2-3	1,2-3	5/1	
	P-04911	Bi-Metal	150	0,9	14		2,5-3,5		5/1	
	P-04927	Bi-Metal	200	0,9	14	1,2-3,5	2,5-3,5	1,2-3,5	5/1	
	P-04933	Bi-Metal	200	0,9	18		1,5-3	1,5-3	5/1	
	P-04949	Bi-Metal	200	0,9	24	1,5-3	1,2-3	1,2-2	5/1	
	P-04955	Bi-Metal	150	0,9	32	1,2-3,5	1,2	0,5-1	5/1	
	P-04983	Bi-Metal	280	0,9	10	3,5-5	3,5-5	3,5-5	5/1	
	P-05088	Bi-Metal	150	1,27	6				5/1	





## Žagini listi za gradbene materiale



	Koda	Material rezila	Debelina rezila (mm)	Celotna dolžina (mm)	Število zob na colo	Eternit, lito železo (mm)	Siporeks, opeka (mm)	Porobeton, Pu-pena (mm)	Les z žebli (mm)	Cena z DDV
	B-10394	HM	1,5	305	2		0-215			
	B-10403	HM	1,5	455	2		0-365			
	B-49834	TC/HM	1,25	152	6-8				5-100	
	B-49834-10	TC/HM	1,25	152	6-8				5-100	
	B-49840	TC/HM	1,25	228	6-8				5-175	
	B-49840-10	TC/HM	1,25	228	6-8				5-175	
	B-49856	TC/HM	1,25	305	6-8				5-250	

Nadaljevanje...

# Pribor za žaganje

Koda	Material rezila	Debelina rezila (mm)	Celotna dolžina (mm)	Število zob na colo	Eternit, lito železo (mm)	Siporeks, opeka (mm)	Porobeton, Pu-pena (mm)	Les z žebli (mm)	Cena z DDV
B-49856-10	TC/HM	1,25	305	6-8				5-250	
P-05038	HM	1,3	90	6	0-75	0-75	0-75		
P-05044	HM	1,3	150	6	0-130	0-130	0-130		
P-05050	HM	1,3	300	6	0-280	0-280	0-280		
P-05066	HM	1,3	400	3	0-380	0-380	0-380		

## Specializirani žagini listi za različne materijale

Koda	Material rezila	Celotna dolžina (mm)	Debelina rezila (mm)	Število zob na colo	Primerne za	Enota (kos/set)	Cena z DDV
B-55566	TC/HM	100	1,25	8	kovina, lito železo, nerjavno jeklo	1	
B-07250	TC/HM	152	1,0	18	plošče iz nerjavnega jekla 2-4 mm, cevi iz nerjavnega jekla s premerom do 80 mm, steklena vlakna	2/1	
B-55572	TC/HM	152	1,25	8	kovina, lito železo, nerjavno jeklo	1	
B-56580	HCS	190	0,6	8,5	veje s premerom do 100 mm, les do 100 mm	1	
B-56596	HCS	190	0,6	15	bambus s premerom do 100 mm, les do 100 mm, PVC do 100 mm	1	
B-51312	TC/HM	203	1,0	18	plošče iz nerjavnega jekla 2-4 mm, cevi iz nerjavnega jekla s premerom do 150 mm, steklena vlakna	2/1	
B-52118	HCS	225	1,5	18	izolacijski material, steklena volna, kamena volna	2/1	
B-57386	BiM	225	0,9	8,5	rezanje mehkega lesa	1	
B-57392	BiM	225	0,9	15	bambus s premerom do 100 mm, les do 100 mm, PVC do 100 mm	1	
B-31871	diamond grit	228	1,0		Cevi iz litega jekla s premerom do 150 mm, opeka 10-175 mm, FRP/epoksi 3-175 mm	2/1	
B-55588	TC/HM	228	1,25	8	kovina, lito železo, nerjavno jeklo	1	
B-62016	HCS	250	0,9	8,5	veje s premerom do 160 mm, bambus s premerom do 160 mm	1	
B-52124	HCS	300	1,5		izolacijski material, steklena volna, kamena volna	2/1	
B-55594	TC/HM	305	1,25	8	kovina, lito železo, nerjavno jeklo	1	
B-63585	HM	305	1,5	3	porobeton, ognjevarno opeko, peščenjak, mavec	1	
B-52130	HCS	400	1,5		izolacijski material, steklena volna, kamena volna	1	

Nadaljevanje...

- Akumulat orj in polnilnik
- Pribor za akumulat orsko svetilko in pribor
- Akumulat orske svetilke in pribor
- Pribor za lasarske merilnike
- Pribor za rušenje in vrtanje
- Pribor za vrtanje
- Kronске žage
- Pribor za vijačenje
- Pribor za rezanje in brušenje
- Pribor za poliranje in brušenje
- Pribor za rezkanje in oblanje
- Pribor za multitank cjsko orodje
- Pribor za žaganje**
- Pribor za žebjalnike in spenjalnike
- Pribor za fene
- Pribor za sesanje
- Pribor orodja za uporabo na prostem
- Pribor za ročno orodje in zaščitna oprema
- Kovčki in torbe za orodje
- Ročno orodje
- Razno
- Pribor za mešanje







# Pribor za žaganje

	Koda	Material rezila	Celotna dolžina (mm)	Debelina rezila (mm)	Število zob na colo	Primerno za	Enota (kos/set)	Cena z DDV
	B-63591	HM	400	1,5	2	porobeton, ognjevarno opeko, peščenjak, mavec	1	

## Žagini listi Super Express, super hiter rez

Revolucionarna rezalna moč. "Super Express" rezila imajo progresivno zasnovano zob, ki lahko enostavno zarezujejo v tanke in debele obdelovance. Makita Super Express rezila so ozka, kar omogoča izjemno hitro rezanje in visokokvalitetne reze. Rezila so idealna za akumulatorske žage, saj zaradi ozke oblike porabijo manj energije, kar omogoča več opravljenega dela z enim akumulatorjem.



	Koda	Material rezila	Celotna dolžina (mm)	Debelina rezila (mm)	Število zob na colo	Primerno za	Enota (kos/set)	Cena z DDV
	B-05038	Bi-Metal	152	0,9	7-18	hitri rez v kovino (železo/jeklo) 1,5-8 mm, aluminij 1-10 mm, plastiko 5-77 mm	5/1	
	B-05038-2	Bi-Metal	152	0,9	7-18	hitri rez v kovino (železo/jeklo) 1,5-8 mm, aluminij 1-10 mm, plastiko 5-77 mm	2/1	
	B-05038-25	Bi-Metal	152	0,9	7-18	hitri rez v kovino (železo/jeklo) 1,5-8 mm, aluminij 1-10 mm, plastiko 5-77 mm	25/1	
	B-05044	Bi-Metal	152	0,9	6-11	hitri rez v barvno kovino (železo/jeklo/aluminij) 5-8 mm, plastiko 5-77 mm in les 5-77 mm	5/1	
	B-05044-2	Bi-Metal	152	0,9	6-11	hitri rez v barvno kovino (železo/jeklo/aluminij) 5-8 mm, plastiko 5-77 mm in les 5-77 mm	2/1	
	B-05044-25	Bi-Metal	152	0,9	6-11	hitri rez v barvno kovino (železo/jeklo/aluminij) 5-8 mm, plastiko 5-77 mm in les 5-77 mm	25/1	
	B-05153	HCS	203	1,0	6-10	hitri rez za les 5-150 mm, plastiko 5-150 mm, iverne plošče/furnir 6-60 mm	5/1	
	B-05153-2	HCS	203	1,0	6-10	hitri rez za les 5-150 mm, plastiko 5-150 mm, iverne plošče/furnir 6-60 mm	2/1	
	B-05153-25	HCS	203	1,0	6-10	hitri rez za les 5-150 mm, plastiko 5-150 mm, iverne plošče/furnir 6-60 mm	25/1	

# Pribor za žaganje

## Žagini listi za živila



Koda	Material rezila	Celotna dolžina (mm)	Debelina rezila (mm)	Število zob na colo	Primerno za	Cena z DDV
B-10609	nerjavno jeklo	305	1,25	3	led/zmrznjene materiale 10-250 mm	
B-23248	nerjavno jeklo	300	1,2	6	led/zmrznjene materiale 10-250 mm	
B-23254	nerjavno jeklo	300	1,2	10	led/zmrznjene materiale 10-250 mm	
B-30564	nerjavno jeklo	228	1,2	6	led/zmrznjene materiale 10-175 mm	
B-30570	nerjavno jeklo	228	1,2	10	led/zmrznjene materiale 10-175 mm	

## Seti različnih žaginskih listov

Koda	Naziv	Material rezila	Vrsta rezila	Celotna dolžina (mm)	Debelina rezila (mm)	Enota (kos/set)	Cena z DDV	
792003-5	Komplet žaginskih listov za sabljasto žago	HCS, HSS	B-00804, B-00810, B-00826	125, 2x165	0,9, 0,9, 1,0	3/1		
B-13677	Komplet žaginskih listov za sabljasto žago	Bi-Metal, HCS	B-05038, B-05044, B-05153	152, 152, 203	0,9, 0,9, 1,0	3/1		
B-44432	Žagin list za sablj. žago (različni)-seta A	Bi-Metal, HCS	2x (B-16798, B-05175, B-05153)	4x 152, 2x 203 mm	1,0 / 1,25 / 1,25	6/1		
B-44448	Žagin list za sablj. žago (različni)-seta B	Bi-Metal	2x (B-05044, B-16776, B-16782)	2x 152, 4x 225	0,9	6/1		

## Žagini listi za JR100D

Koda	Material rezila	Celotna dolžina (mm)	Število zob na colo	Primerno za	Enota (kos/set)	Cena z DDV	
B-20432	Bi-Metal	100	6	trdi les, les z žebli	5/1		
B-20448	Bi-Metal	100	6	mavčne plošče	5/1		
B-20454	Bi-Metal	100	14-18	les in kovine	5/1		

Akumulat orji in polnilniki

Pribor za akumulat orsko orodje

Akumulat orske svetilke in pribor

Pribor za lasarske merilnike

Pribor za rušenje in vrtanje

Pribor za vrtanje

Kronske žage

Pribor za vijačenje

Pribor za rezanje in brušenje

Pribor za poliranje in brušenje

Pribor za rezanje in oblanje

Pribor za multitank ciljsko orodje

Pribor za žaganje

Pribor za žebjalnike in spenjalnike

Pribor za fene

Pribor za sesanje

Pribor orodja za uporabo na prostem

Pribor za čiščenje orodja in zaščitna oprema





Kovčki in torbe za orodje

Ročno orodje

Razno

Pribor za mešanje

## Pribor za JR100D/JR1000FTK

	Koda	Naziv	Celotna dolžina (mm)	Delovna dolžina (mm)	Za model	Enota (kos/set)	Cena z DDV
	A-40945	Okrogla pila	153	60	JR1000FTK	3/1	
	A-40967	Brusilni adapter	153	90	JR1000FTK	1	
	B-04977	Brusni papir	/	95 x 22	JR1000FTK	10/1	
	B-04983	Brusni papir	/	95 x 22	JR1000FTK	10/1	

## Tračne žage



## Žagini listi

Koda	Material rezila	Dolžina rezila tračne žage (mm)	Širina rezila tračne žage (mm)	Največja zmogljivost rezanja (mm)	Število zob na colo	Primerno za	Za model	Enota (kos/set)	Cena z DDV
194692-6	HSS	1.140	13	< 4	24	plastika, barvne kovine, jeklo, lito železo, litine, nerjavno jeklo, kaljeno jeklo	2106, 2107FK, DPB180, PB002G	1	
792556-4	HSS	1.140	13	4-5	18	plastika, barvne kovine, jeklo, lito železo, litine, nerjavno jeklo, kaljeno jeklo	2106, 2107FK, DPB180, PB002G	1	
792557-2	HSS	1.140	13	> 5	14	plastika, barvne kovine, jeklo, lito železo, litine, nerjavno jeklo, kaljeno jeklo	2106, 2107FK, DPB180, PB002G	1	
792558-0	ogljikovo legirano jeklo	1.140	13	< 4	24	plastika, barvne kovine, mehko jeklo, lito železo, litine	2106, 2107FK, DPB180, PB002G	3/1	
792559-8	ogljikovo legirano jeklo	1.140	13	4-5	18	plastika, barvne kovine, mehko jeklo, lito železo, litine	2106, 2107FK, DPB180, PB002G	3/1	
792560-3	ogljikovo legirano jeklo	1.140	13	> 5	14	plastika, barvne kovine, mehko jeklo, lito železo, litine	2106, 2107FK, DPB180, PB002G	3/1	
792567-9	ogljikovo legirano jeklo	1.140	13	/	6	les	2106, 2107FK, DPB180, PB002G	3/1	
B-30128	BiM	1.140	13	> 6	10	kovine, nerjavno jeklo	2106, 2107FK, DPB180, PB002G		
B-40543	BiM	835	13	3-6	14	plastika, barvne kovine, jeklo, lito železo, litine, nerjavno jeklo, kaljeno jeklo	DPB181, DPB182, DPB183	5/1	
B-40559	BiM	835	13	2-3	18	plastika, barvne kovine, jeklo, lito železo, litine, nerjavno jeklo, kaljeno jeklo	DPB181, DPB182, DPB183	5/1	
B-40565	BiM	835	13	< 2	24	plastika, barvne kovine, jeklo, lito železo, litine, nerjavno jeklo, kaljeno jeklo	DPB181, DPB182, DPB183	5/1	
E-04101	BiM	730	13	3-6	14	kovina	DPB184	5/1	
E-04117	BiM	730	13	2-3	18	kovina	DPB184	5/1	

[Nadaljevanje...](#)

# Pribor za žaganje

Koda	Material rezila	Dolžina rezila tračne žage (mm)	Širina rezila tračne žage (mm)	Največja zmogljivost rezanja (mm)	Število zob na colo	Primerno za	Za model	Enota (kos/set)	Cena z DDV
E-04123	BiM	730	13	< 2	24	kovina	DPB184	5/1	
B-16673	HCS	2.240	13	/	4	les	LB1200F	3/1	
B-16689	HCS	2.240	6	/	6	les	LB1200F	3/1	
B-16695	HCS	2.240	16	/	14	kovina	LB1200F	3/1	
JM21080294	/	2.240	6	/	6	les	LB1200F	1	
JM21080295	/	2.240	13	/	4	les	LB1200F	1	
JM21080296	/	2.240	16	/	4	les	LB1200F	1	
JM21080297	/	2.240	16	/	14	kovina	LB1200F	1	

## Ostali pribor

Koda	Naziv	Za model	Cena z DDV	
194069-5	Pokrov in stojalo za tračno žago	2106, 2107FK, DPB180		
194070-0	Pokrov plošče	2106, 2107FK, DPB180		
197975-3	Pokrov plošče	DPB181, DPB182		
JM21000300	Podaljšek mize	LB1200F		
JM21000320	Priključek za rezanje	LB1200F		
JM21000330	Priključek za brušenje (papir 2.240x20 mm)	LB1200F		
JM21080230	Vzporedni prislon	LB1200F		
JM21080260	Kotno vodilo	LB1200F		
JM21080290	Potisna palica	LB1200F, LH1200FL		
191897-9	Rezalni vosek za prenosno tračno žago	LC1230, 2106, 2107FK, DPB180, DPB181, DPB182, DPB183, DPB184		

Nadaljevanje...

Akumulat  
ori in  
polnilnik

Pribor za  
akumulat  
orsko  
svetilke  
in pribor

Akumulat  
orske  
svetilke  
in pribor

Pribor za  
lasarske  
merilnike

Pribor za  
rušenje  
in vrtanje

Pribor za  
vrtanje

Kronske  
žage

Pribor za  
vijačenje

Pribor za  
rezanje  
in  
brušenje

Pribor za  
poliranje  
in  
brušenje

Pribor za  
rezkanje  
in  
oblanje

Pribor za  
multifunk  
cijsko  
orodje

Pribor za  
žaganje

Pribor za  
žebjalnike  
in  
spenjalnike

Pribor za  
fene

Pribor za  
sesanje

Pribor  
orodja za  
uporabo  
na prostem

Pribor za  
prosta  
orodja in  
zaščitna  
oprema

Kovčki in  
torbe za  
orodje

Ročno  
orodje

Razno  
orodje

Pribor za  
mešanje

# Pribor za žaganje

	Koda	Naziv	Za model	Cena z DDV
	JM23300008	Vzporedni prislon	LH1200FL	

## Verižni rezkarji

### Pribor

	Koda	Naziv	Širina reza (mm)	Za model	Cena z DDV
	A-16570	Rezalna veriga	16,5	7104L	
	A-16586	Rezalna veriga	18	7104L	
	A-16592	Rezalna veriga	21	7104L	
	A-16601	Rezalna veriga	24	7104L	
	P-22084	Rezalna veriga	40	KC100	
	P-22090	Rezalna veriga	50	KC100	
	P-22109	Meč	30	KC100	
	P-22115	Meč	40	KC100	
	P-22121	Meč	50	KC100	
	P-22137	Verižnik	30	KC100	
	P-22143	Verižnik	40	KC100	



## Ostali pribor za žaganje

### Vodilne letve in torbe



Koda vodilne letve	Dolžina	Koda torbe
199140-0	1,0 m	E-05670
199141-8	1,5 m	E-05664
194925-9	1,9 m	E-10920
194367-7	3,0 m	E-10936

### Spone za vodilne letve



Koda	Naziv	Enota (kos/set)
194385-5	Spona vodilne letve	2/1
199826-6	Hitra spona za vodilne letve	2/1
198885-7	Set za spajanje vodilnih letev	2/1

### Nastavljiva kotna vodila za vodilne letve



Koda	Naziv	Razpon
196664-7	Nastavljivo kotno vodilo za vodilne letve	0 - 180°

### Trakovi za vodilne letve

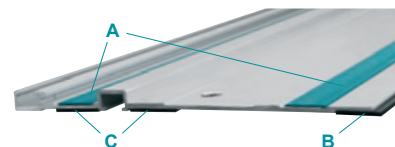

Koda	Naziv	Tip	Dolžina
413101-9	Drсни trak	A	1,4 m
413102-7	Drсни trak	A	3,0 m
194416-0	Drсни trak	A	10,0 m
423359-2	Gumijasti vodilni trak	B	1,4 m
423360-7	Gumijasti vodilni trak	B	3,0 m
423361-5	Protizdrsni penasti trak	C	1,4 m
423362-3	Protizdrsni penasti trak	C	3,0 m
194417-8	Protizdrsni penasti trak	C	10,0 m

### Vzporedni prisloni



Koda	Za model
165153-3*	DRS780, RS001G, RS002G
164367-1	HS0600, N5900B
165447-6*	DSP600, DSP601, SP6000
165084-6	5103R, 5104S, 5903R
164021-7	5800BR, 5900BR
164095-8*	4131, 5008MG, DCS552, DCS553, DHS630, DHS660, DHS680, DHS710, HS301D, HS7101, HS7601, HS7611, M5802
165108-8	5017RKB, 5603R, 5705R
152498-8	5143R

\*Krilni vijak za prislon - 265701-9

Akumulat orji in polnilniki  
 Pribor za akumulat orsko orodje  
 Akumulat orske svetilke in pribor  
 Pribor za lasarske merilnike  
 Pribor za rušenje in vrtanje  
 Pribor za vrtanje  
 Pribor za kronске žage  
 Pribor za vijachenje  
 Pribor za rezanje in brušenje  
 Pribor za poliranje in brušenje  
 Pribor za rezkanje in oblanje  
 Pribor za multitank ciljsko orodje  
 Pribor za žaganje  
 Pribor za žebjalnike in spenjalnike  
 Pribor za fene  
 Pribor za sesanje  
 Pribor orodja za uporabo na prostem  
 Pribor za nošenje orodja in zaščitna oprema  
 Kovčki in torbe za orodje  
 Ročno orodje  
 Razno  
 Pribor za mešanje

## Adapterji za vodilne letve

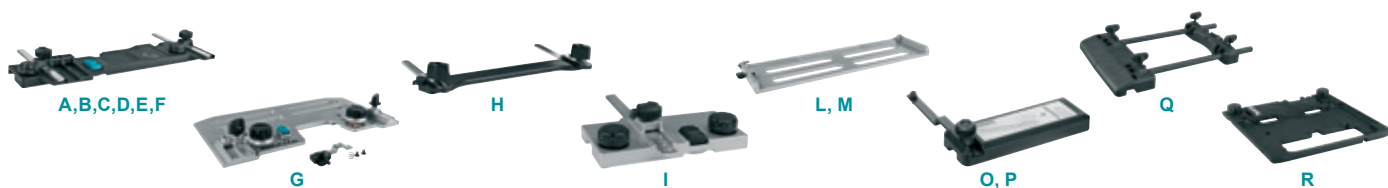

	A	B	C	D	E	F	G	H	I	L	M	O	P	Q	R
	Krožne žage											Vbodne žage	Rezarji, nadrezkarji	Rezalniki	
Za model	HS7100, HS7101	DHS630, HS6100, HS6101	HS7601, HS7610, HS7611	DHS680	HS6600, HS6601	DHS630, HS6100, HS6101, HS7100, HS7101	HS0600	5705R	DHS660, DHS661	5903R	5103R	DJV180, DJV181, DJV182, 4350FCT, 4351FCT	JV102D, JV103D	DRT50* RT0702C*, RP0900, RP1110C, RP1111C, RP1800, RP1801, RP1803, RP2300FC, RP2301FC, RP2302FC, RP2303FC	DCC500, 4100KB
Koda	195837-9	195838-7	197005-0	196953-0	197462-2	197252-3	198570-2	192505-5	199232-5	192506-3	192507-1	193517-1	198704-7	194579-2	198673-2

\*Uporabiti s potopnim podnožjem 195563-0











# Pribor za žaganje

249

## Ostali pribor za žaganje

### Mize za stabilne žage

Koda	Naziv	Mere (D x Š x V) (mm)	Za model	Cena z DDV	
194093-8	Zložljiva miza	655 x 810 x 630	2704		
198687-1	Zložljiva miza WST01N	2.750 x 660 x 840	LS0713, DLS713, LS1040, LS1440, MT230, MLS100, LS1213, LS1016, LS1216, LS1018		
198688-9	Stojalo	740 x 750 x 835	LS1019L		
198689-7	Stojalo za skobeljnik	170 x 1.055 x 790	2012NB		
DEAWST05	Delovna miza za namizne žage	2.700 x 500 x 800/500	LS0714FB, LS1016, LS1018L, LS1019, LS1040F, LS1216, LS1440, LH1040, LH1200, MLS100, DLS211, LS003G		
DEAWST07	Nastavljiva delovna miza za namizne žage WST07	3.830/1765 x 750 x 860	Not for DLS600, LH1040F, LH1201FL		
DEBWST06	Delovna miza za namizne žage	2.550/1.150 x 750 x 850	LS0714FB, LS1016, LS1018L, LS1019, LS1040F, LS1216, LS1440, MLS100, LS003G		
JM27000300	Zložljiva miza	1.015 x 590 x 560	MLT100N, 2702, 2703		

### Pribor za žage

Koda	Naziv	Za model	Enota (kos/set)	Cena z DDV	
122536-0	Navpični primež	LH1040/F, LS1040/F	1		
122538-6	Navpični primež	LS1013/F/L	1		

[Nadaljevanje...](#)

Akumulat  
orji in  
poinliniki

Pribor za  
akumulat  
orsko  
orodje

Akumulat  
orske  
svetilke  
in pribor

Pribor za  
lasarske  
merilnike

Pribor za  
rušenje  
in vrtanje

Pribor za  
vrtanje

Kronске  
žage

Pribor za  
vijačenje

Pribor za  
rezanje  
in  
brušenje

Pribor za  
poliranje  
in  
brušenje

Pribor za  
rezkanje  
in  
oblanje

Pribor za  
multifunk  
cijsko  
orodje

Pribor za  
žaganje

Pribor za  
žebjalnike  
in  
spenjalnike

Pribor za  
fene

Pribor za  
sesanje

Pribor  
orodja za  
uporabo  
na prostem

Pribor za  
nosače  
orodja in  
zaščitna  
oprema















Kovčki in  
torbe za  
orodje

Ročno  
orodje

Razno

Pribor za  
mešanje

# Pribor za žaganje

	Koda	Naziv	Za model	Enota (kos/set)	Cena z DDV
Akumulat orji in poinliniki					
Pribor za akumulat orsko orodje	 122540-9	Navpični primež	LS1214/L/F	1	
Akumulat orske svetilke in pribor	 122556-4	Vzporedni prislon	2702	1	
Pribor za laserske merilnike	 122563-7	Vodoravni primež	DLS713, LS0714/FL, LH1040/F, LS1040/F, DLS211, LS002G	1	
Pribor za rušenje in vrtanje	 122571-8	Navpični primež	DLS713, DLS714, LS0714, LS0714FL, LS1214, LS1214FL	1	
Pribor za vrtnje	 122707-9	Vzporedni prislon	LH1040/F, LS1040	1	
Kronske žage	 122728-1	Navpični primež	LF1000	1	
Pribor za vijačenje	 122729-9	Vzporedni prislon	LF1000	1	
Pribor za rezanje in brušenje	 122731-2	Pokrov	LF1000	1	
Pribor za poliranje in brušenje	 122739-6	Vzporedni prislon	2704	1	
Pribor za rezkanje in oblanje	 122740-1	Vzporedni prislon	2704	1	
Pribor za multitank cjsko orodje	 122854-6	Navpični primež	LS1216L, LS1016L	1	
Pribor za žaganje	 122930-6	Vodoravni primež	LS1216L, LS1018L	1	
Pribor za žebjalnike in spenjalnike	 123101-8	Držalo	LS1040/F, DLS713	1	
Pribor za fene	 126617-2	Navpični primež	LS1019L, DLS211, LS003G	1	
Pribor za sesanje	 127069-0	Kotni prislon	2704	1	
Pribor orodja za uporabo na prostem					
Pribor za nosenje orodja in zaščita oprema					
Kovčki in torbe za orodje					
Ročno orodje					
Razno					
Pribor za mešanje					

[Nadaljevanje...](#)



# Pribor za žaganje

251

Koda	Naziv	Za model	Enota (kos/set)	Cena z DDV	
153896-9	Pomožni desni prislon	LS1013/L/F, LS1214/F/L	1		
191U61-8	Set za podnožje	LS004G	1		
192625-5	Navpični primež	LH1040	1		
192628-9	Omejilnik (levi in desni)	LS1013, LS1019/L, LS1214, LS003G	2/1		
193730-1	Fluorescentna svetilka, 5 W	2107F, LS0714, LS1013, LS1040F, LS1214F	1		
194086-5	Levi podaljšek mize	2704	1		
194087-3	Zadnji podaljšek mize	2704	1		
194241-9	Dršno vodilo	2704	1		
195253-5	Omejilnik	LS1216L, DLS211	1		
322932-4	Podaljšek mize	LS1013/F/L, LS1214/F/L	1		
JM00000219	Premično podnožje za WST07	WST07, WST06	2/1		
JM21080290	Potisna palica	LB1200F, LH1200FL			
JM23000127	Podaljšek mize	MLS100, LS0815	1		
JM23000131	Navpični primež	MT230	1		

[Nadaljevanje...](#)

Akumulator  
orj in  
poinliniki

Pribor za  
akumulator  
orsko  
orodje

Akumulator  
orske  
svetilke  
in pribor

Pribor za  
lasarske  
merilnike

Pribor za  
rušenje  
in vrtanje

Pribor za  
vrtanje

Kronске  
žage

Pribor za  
vijačenje

Pribor za  
rezanje  
in  
brušenje

Pribor za  
poliranje  
in  
brušenje

Pribor za  
rezkanje  
in  
oblanje

Pribor za  
multifunk  
cljsko  
orodje

Pribor za  
žaganje

Pribor za  
žebjalnike  
in  
spenjalnike

Pribor za  
fene

Pribor za  
sesanje

Pribor  
orodja za  
uporabo  
na prostem

Pribor za  
ročna  
orodja in  
zaščitna  
oprema

Kovčki in  
torbe za  
orodje









Ročno  
orodje

Razno  
orodje

Pribor za  
mešanje



# Pribor za žaganje

	Koda	Naziv	Za model	Enota (kos/set)	Cena z DDV
	JM23100500	Podaljšek mize	LS1018L, LH1200FL	1	
	JM23100502	Navpični primež	LS1018L, LH1200FL	1	
	JM23610050	Premično podnožje za WST06	WST06	2/1	
	JM27000046	Zadnji podaljšek mize	MLT100	1	
	JM27000068	Desni podaljšek mize	MLT100	1	
	JM27000201	Vzporedni prislon	MLT100	1	
	JM27000202	Vzporedni prislon	MLT100X	1	
	JM27000224	Kotni prislon	MLT100X	1	
	JM27000328	Nastavitveni trikotnik	MLT100, LS1018L, LH1200L	1	

- Akumulat orji in polnilniki
- Pribor za akumulat orsko orodje
- Akumulat orske svetilke in pribor
- Pribor za laserske merilnike
- Pribor za rušenje in vrtanje
- Pribor za vrtanje
- Kronske žage
- Pribor za vijačenje
- Pribor za rezanje in brušenje
- Pribor za poliranje in brušenje
- Pribor za rezanje in oblanje
- Pribor za multitank cijsko orodje
- Pribor za žaganje**
- Pribor za žebjalnike in spenjalnike
- Pribor za fene
- Pribor za sesanje
- Pribor orodja za uporabo na prostem
- Pribor za nošenje orodja in zaščita oprema
- Kovčki in torbe za orodje
- Ročno orodje
- Razno
- Pribor za mešanje

# PRIBOR ZA ŽEBLJALNIKE IN SPENJALNIKE

Žebli, speti z žico



Žebli, speti s papirjem



Posamično/rafalno zabijanje



## Žebjalniki

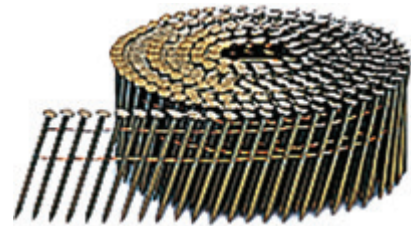

## Kolut z gladkimi žebli



Koda	Premer (Ø) (mm)	Celotna dolžina (mm)	Naklon (°)	Prevleka	Za model	Enota (kos/set)	Cena z DDV
F-30810	2,5	45	16	protikorozijska	AN621, AN901, AN902, AN610H, AN620H, AN711H, AN911H, AN960, AN961, AN635H, AN935H, AN613	10.800/1	
F-30900	2,5	65	16	protikorozijska	AN621, AN901, AN902, AN610H, AN620H, AN711H, AN911H, AN960, AN961, AN635H, AN935H, AN613	8.100/1	
F-31243	2,5	50	16	protikorozijska	AN621, AN901, AN902, AN610H, AN620H, AN711H, AN911H, AN960, AN961, AN635H, AN935H, AN613	10.800/1	
F-30823	2,8	50	16	protikorozijska	AN621, AN901, AN902, AN610H, AN620H, AN711H, AN911H, AN960, AN961, AN635H, AN935H	9.000/1	
F-30849	2,9	50	16	protikorozijska	AN621, AN901, AN902, AN610H, AN620H, AN711H, AN911H, AN960, AN961, AN635H, AN935H	9.000/1	
F-30836	3,1	65	16	protikorozijska	AN621, AN901, AN902, AN610H, AN620H, AN711H, AN911H, AN960, AN961, AN635H, AN935H	6.750/1	
F-31298	3,1	75	16	protikorozijska	AN621, AN901, AN902, AN610H, AN620H, AN711H, AN911H, AN960, AN961, AN635H, AN935H	4.050/1	
F-31304	3,1	83	16	protikorozijska	AN621, AN901, AN902, AN610H, AN620H, AN711H, AN911H, AN960, AN961, AN635H, AN935H	4.050/1	
F-31317	3,1	90	16	protikorozijska	AN621, AN901, AN902, AN610H, AN620H, AN711H, AN911H, AN960, AN961, AN635H, AN935H	4.050/1	
F-30852	3,3	65	16	protikorozijska	AN621, AN901, AN902, AN610H, AN620H, AN711H, AN911H, AN960, AN961, AN635H, AN935H	4.050/1	
F-31359	3,4	75	16	protikorozijska	AN621, AN901, AN902, AN610H, AN620H, AN711H, AN911H, AN960, AN961, AN635H, AN935H	3.600/1	
F-31362	3,8	90	16	protikorozijska	AN621, AN901, AN902, AN610H, AN620H, AN711H, AN911H, AN960, AN961, AN635H, AN935H	2.700/1	

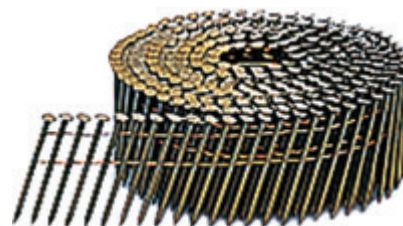

## Kolut z vijačnimi žebli



Koda	Premer (Ø) (mm)	Celotna dolžina (mm)	Naklon (°)	Prevleka	Za model	Enota (kos/set)	Cena z DDV
F-30865	2,5	50	16	protikorozijska	AN610H, AN620H, AN621, AN711H, AN901, AN902, AN911H, AN930H, AN960, AN961, AN935, AN635H	10.800/1	
F-31269	2,5	65	16	protikorozijska	AN610H, AN620H, AN621, AN711H, AN901, AN902, AN911H, AN930H, AN960, AN961, AN935, AN635H	8.100/1	
F-30881	2,9	65	16	protikorozijska	AN610H, AN620H, AN621, AN711H, AN901, AN902, AN911H, AN930H, AN960, AN961, AN935, AN635H	6.750/1	
F-30971	2,9	50	16	protikorozijska	AN610H, AN620H, AN621, AN711H, AN901, AN902, AN911H, AN930H, AN960, AN961, AN935, AN635H	9.000/1	
F-31272	2,9	57	16	protikorozijska	AN610H, AN620H, AN621, AN711H, AN901, AN902, AN911H, AN930H, AN960, AN961, AN935, AN635H	6.750/1	
F-31285	2,9	71	16	protikorozijska	AN610H, AN620H, AN621, AN711H, AN901, AN902, AN911H, AN930H, AN960, AN961, AN935, AN635H	6.750/1	
F-31333	3,1	85	16	protikorozijska	AN610H, AN620H, AN621, AN711H, AN901, AN902, AN911H, AN930H, AN960, AN961, AN935, AN635H	4.050/1	
F-31320	3,2	75	16	protikorozijska	AN610H, AN620H, AN621, AN711H, AN901, AN902, AN911H, AN930H, AN960, AN961, AN935, AN635H	4.050/1	
F-31346	3,2	90	16	protikorozijska	AN610H, AN620H, AN621, AN711H, AN901, AN902, AN911H, AN930H, AN960, AN961, AN935, AN635H	4.050/1	

 Akumulat  
orji in  
poinliniki

 Pribor za  
akumulat  
orsko  
orodje

 Akumulat  
orske  
svetilke  
in pribor

 Pribor za  
lasarske  
merilnike

 Pribor za  
rušenje  
in vrtanje

 Pribor za  
vrtanje

 Kronske  
žage

 Pribor za  
vijačenje

 Pribor za  
rezanje  
in  
brušenje

 Pribor za  
poliranje  
in  
brušenje

 Pribor za  
rezkanje  
in  
oblanje

 Pribor za  
multifunk  
ciljsko  
orodje

 Pribor za  
žaganje

 Pribor za  
žebjalnike  
in  
spenjalnike

 Pribor za  
fene

 Pribor za  
sesanje

 Pribor  
orodja za  
uporabo  
na prostem

 Pribor za  
prosto  
orodje in  
zaščitna  
oprema

 Kovčki in  
torbe za  
orodje

 Ročno  
orodje

Razno

 Pribor za  
mešanje



## Gladki žebli (D-glava) na papirnem traku



Koda	Premer (Ø) (mm)	Celotna dolžina (mm)	Naklon (°)	Prevleka	Za model	Enota (kos/set)	Cena z DDV
P-45783	2,9	50	34	galvanizirana	AN943	3.300/1	
F-30579	3,1	75	34	brez	AN943	3.000/1	
F-30601	3,1	83	34	brez	AN943	3.000/1	
F-31645	3,3	90	34	galvanizirana	AN943	3.000/1	

## Žeblički 18GA



Koda	Celotna dolžina (mm)	Prevleka	Za model	Enota (kos/set)	Cena z DDV
F-31867	15	galvanizirana	AF505, AF506, AF550H, DBN500, DFN350	5.000/1	
F-31870	20	galvanizirana	AF505, AF506, AF550H, DBN500, DFN350	5.000/1	
F-31883	25	galvanizirana	AF505, AF506, AF550H, DBN500, DFN350	5.000/1	
F-31896	30	galvanizirana	AF505, AF506, AF550H, DBN500, DFN350	5.000/1	
F-31902	32	galvanizirana	AF505, AF506	5.000/1	
F-31915	35	galvanizirana	AF505, AF506, AF550H, DBN500, DFN350	5.000/1	
F-31928	38	galvanizirana	AF505, AF506, AF550H, DBN500	5.000/1	
F-31931	40	galvanizirana	AF505, AF506, AF550H, DBN500	5.000/1	
F-31944	45	galvanizirana	AF505, AF506, AF550H, DBN500	5.000/1	
F-31957	50	galvanizirana	AF505, AF506, AF550H, DBN500	5.000/1	
F-32946	55	galvanizirana	AF550H	5.000/1	

## Iglice 23GA



Koda	Celotna dolžina (mm)	Prevleka	Za model	Enota (kos/set)	Cena z DDV
F-31825	18	galvanizirana	AF201Z, DPT351, DPT353, AF353, PT354D	10.000/1	
F-32142	18	nerjaveči	AF201Z, DPT351, DPT353, AF353, PT354D	10.000/1	

[Nadaljevanje...](#)



# Pribor za žebjalnike in spenjalnike

257

Koda	Celotna dolžina (mm)	Prevleka	Za model	Enota (kos/set)	Cena z DDV
F-31838	25	galvanizirana	AF201Z, DPT351, DPT353, AF353, PT354D	10.000/1	
F-32155	25	nerjaveči	AF201Z, DPT351, DPT353, AF353, PT354D	10.000/1	
F-31841	30	galvanizirana	DPT351, DPT353, AF353, PT354D	10.000/1	
F-32168	30	nerjaveči	DPT351, DPT353, AF353, PT354D	10.000/1	
F-31854	35	galvanizirana	DPT351, DPT353, AF353, PT354D	10.000/1	
F-32171	35	nerjaveči	DPT351, DPT353, AF353, PT354D	10.000/1	

## Spenjalniki



### Sponke 16GA

Koda	Širina (mm)	Celotna dolžina (mm)	Prevleka	Za model	Enota (kos/set)	Cena z DDV
P-75091	11	25	galvanizirana	AT1150A	28.000/1	
P-75100	11	28	galvanizirana	AT1150A	14.000/1	
P-75116	11	32	galvanizirana	AT1150A	14.000/1	
P-75122	11	35	galvanizirana	AT1150A	14.000/1	
P-75138	11	40	galvanizirana	AT1150A	14.000/1	

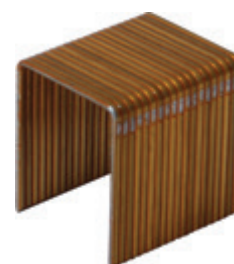

### Sponke 16GA

Koda	Širina (mm)	Celotna dolžina (mm)	Prevleka	Za model	Enota (kos/set)	Cena z DDV
F-32023	25	25	galvanizirana	AT2550A	10.000/1	
F-32036	25	32	galvanizirana	AT2550A	10.000/1	
F-32049	25	38	galvanizirana	AT2550A	10.000/1	
P-75079	25	38	galvanizirana	AT2550A	9.200/1	
F-32052	25	45	galvanizirana	AT2550A	10.000/1	

Akumulat  
orji in  
poinliniki

Pribor za  
akumulat  
orsko  
orodje

Akumulat  
orske  
svetilke  
in pribor

Pribor za  
lasarske  
merilnike

Pribor za  
rušenje  
in vrtanje

Pribor za  
vrtanje

Kronske  
žage

Pribor za  
vijačenje

Pribor za  
rezanje  
in  
brušenje

Pribor za  
poliranje  
in  
brušenje

Pribor za  
rezanje  
in  
oblanje

Pribor za  
multifunk  
cijsko  
orodje

Pribor za  
žaganje

Pribor za  
žebjalnike  
in  
spenjalnike

Pribor za  
fene

Pribor za  
sesanje

Pribor  
orodja za  
uporabo  
na prostem

Pribor za  
ročno  
orodje in  
zaščitna  
oprema

Kovčki in  
torbe za  
orodje

Ročno  
orodje

Razno

Pribor za  
mešanje

# Pribor za žebjalnike in spenjalnike



## Sponke 18GA

Koda	Širina (mm)	Celotna dolžina (mm)	Prevleka	Za model	Enota (kos/set)	Cena z DDV
F-33607	6,3	25	brez	AT638	5.000/1	
F-33610	6,3	28	brez	AT638	5.000/1	
F-33623	6,3	30	brez	AT638	5000/1	
F-33636	6,3	32	brez	AT638	5.000/1	
F-33649	6,3	38	brez	AT638	5.000/1	



## Sponke za akumulatorske spenjalnike

Koda	Širina (mm)	Celotna dolžina (mm)	Debelina žice (mm)	Širina žice (mm)	Za model	Enota (kos/set)	Cena z DDV
F-32904	10	6	0,6	1,2	DST221	5.040/1	
F-81518	10	7	0,5	0,75	DST110, ST113D, DST112	2.500/1	
F-32917	10	8	0,6	1,2	DST221	5.040/1	
F-32647	10	10	0,6	1,2	DST220, DST221, T221D	5.040/1	
F-81521	10	10	0,5	0,75	DST110, ST113D, DST112	2.500/1	
F-32650	10	13	0,6	1,2	DST220, DST221, T221D	5.040/1	
F-32663	10	16	0,6	1,2	DST220, DST221, T221D	5.040/1	
F-32676	10	19	0,6	1,2	DST220, DST221, T221D	5.040/1	
F-32689	10	22	0,6	1,2	DST220, DST221, T221D	5.040/1	

## Pribor

Koda	Naziv	Za model	Cena z DDV
181434-7	Strojno olje, 30 ml	/	





422464-2

Ščitnik

DFN350

[Nadaljevanje...](#)

# Pribor za žebjalnike in spenjalnike

Koda	Naziv	Za model	Cena z DDV	
422665-2	Gumirana zaščita FN001G	FN001G		
HY00000561	Gumirana zaščita AF353	AF353		

- Akumulat orji in polnilniki
- Pribor za akumulat orsko orodje
- Akumulat orske svetilke in pribor
- Pribor za lasarske mešanike
- Pribor za rušenje in vrtanje
- Pribor za vrtanje
- Kronske žage
- Pribor za vijačenje
- Pribor za rezanje in brušenje
- Pribor za poliranje in brušenje
- Pribor za rezkanje in oblanje
- Pribor za multitfunkcijsko orodje
- Pribor za žaganje
- Pribor za žebjalnike in spenjalnike**
- Pribor za fene
- Pribor za sesanje
- Pribor orodja za uporabo na prostem
- Pribor za ročno orodje in zaščitna oprema
- Kovčki in torbe za orodje
- Ročno orodje
- Razno
- Pribor za mešanje

# PRIBOR ZA FENE



# IZBOR STROKOVNJAKOV



Šoba za zaščito stekla

Široka šoba

Reducirna šoba

Reflektorska šoba



Varilna šoba

Šoba za hitro varjenje

Varilna šoba

Spajkalni odbojnik



Valjček za potiskanje

Strgalo

4delni set za strganje

Varilne žice (PP, HDPE, ABS)



A Ustrezna uporaba  
B Priložen pribor ob nakupu

PRIBOR	KODA	HG6030K	HG5030K	HG6031VK	HG6531CK	DHG180	DHG181
1 Šoba za zaščito stekla	PR00000028	A	A	A	A / B	A / B	A / B
2 Široka šoba	PR00000029	A	A	A	A / B	A / B	A / B
3 Reducirna šoba	PR00000031	A	A	A	A / B	A / B	A / B
4 Reflektorska šoba	PR00000030	A	A	A	A / B	A / B	A / B
5 Varilna šoba	PR00000034	A	A	A	A / B	A	A
6 Šoba za hitro varjenje	PR00000039	A	A	A	A	A	A
7 Varilna šoba	PR00000032	A	A	A	A / B	A	A
8 Šoba za spajkanje	PR00000033	A	A	A	A / B	A	A
9 Valjček za potiskanje	PR00000035	A	A	A	A / B	A	A
10 Strgalo	PR00000040 PR00000042	A A	A A	A A	A A	A A	A A
11 4 delni set za strganje	PR00000041	A	A	A	A	A	A
12 Varilne žice	PP	PR00000038	-	-	-	A	A
	HDPE	PR00000037	-	-	-	A	A
	ABS	PR00000036	-	-	-	A	A
Kovček		B	B	B	B	B	B



# PRIBOR ZA SESANJE





# Pribor za akumulatorske sesalnike

## ZA MODELE Z ZBIRALNO POSODO

CL001G, DCL281F, DCL280F, CL183D, DCL180, CL111D, CL106FD, CL070D, CL100D, CL108FD

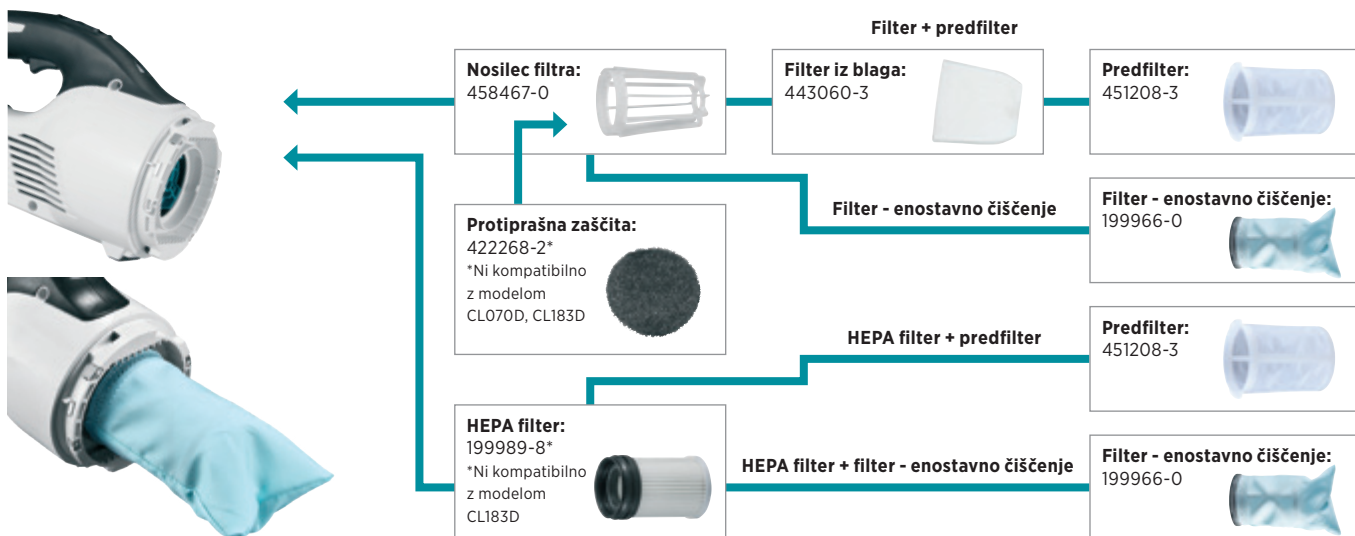

## ZA MODELE Z VREČKO ZA PRAH

CL002G, DCL184, CL114F, CL121D, CL107FD, CL104D, CL121D



## AKUMULATORSKI NAHRBTNI SESALNIK

DVC261, DVC265

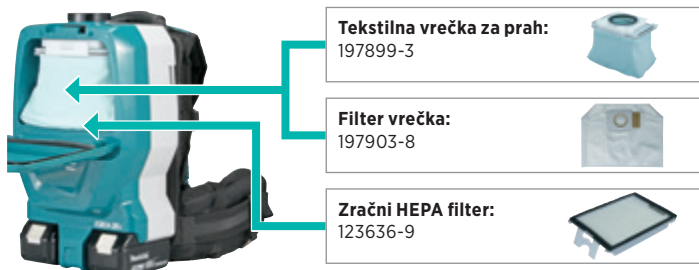

## AKUMULATORSKI NAHRBTNI SESALNIK

VC008G, VC009G, DVC660

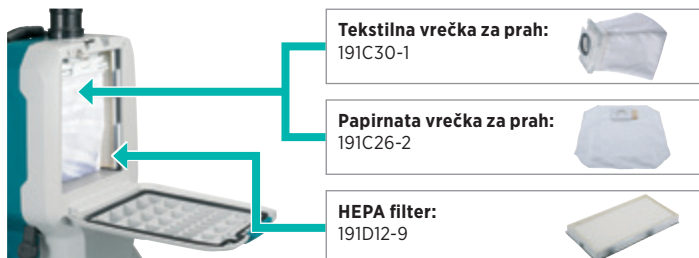





A	B	C	D	E	F
Z Ø28 mm cevjo	Z Ø28 mm cevjo	Z Ø38 mm cevjo	Z Ø28 mm cevjo	Z Ø32 mm cevjo	Z Ø32 mm cevjo
<b>Model</b> VC3211H / VC3211M VC2211M / VC3210L	<b>Model</b> DVC155L DVC864L / DVC865L DVC867L	<b>Model</b> VC001GL / VC003GL VC005GL DVC150L / DVC152L DVC157L / DVC860L DVC864L / DVC867L	<b>Model</b> DVC260 / DVC261 DVC265 / DVC660 VC009G / VC008G	<b>Model</b> VC2000L / VC2012L VC2512L / VC3011L	<b>Model</b> VC3012L / VC4210L VC4210M
<b>Priključki</b> 	<b>Priključki</b> 	<b>Adapter</b> 	<b>Priključki</b> 	<b>Adapter 24</b> P-81745 <b>Adapter 38</b> P-70421 	<b>Adapter 22</b> W107418678 <b>Adapter 24</b> P-70378 <b>Adapter 38</b> W107418688 
38 24 22	38 24 22	22-38	38 24 22	24 38	22 24 38

Za model	Tip sesalnih sistemov
----------	-----------------------

## Rušilna in vrtna kladiva



Za model	Tip sesalnih sistemov
----------	-----------------------

## Vrtna kladiva

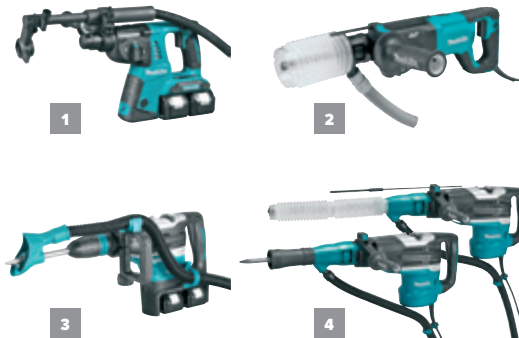

	Model	Odsevalni nastavek	Velikost priključka
Rušilno kladivo	HM1501, HM1502, HM1512	191M21-2 (brez cevi)	Cev ø28 direktno
		191M20-4 (s cevjo)	Prikljček 24 ali 38
	HM1307C, HM1317C, HM1802, HM1812	197168-2 (brez cevi)	Cev ø28 direktno
		197148-8 (s cevjo)	Prikljček 24 ali 38
HM001G, HM002G, HM0870C, HM0871C, HM1101C, HM1111C, HM1203C, HM1205C, HM1213C, HM1214C	199143-4 (brez cevi)	Cev ø28 direktno	
	199144-2 (s cevjo)	Prikljček 24 ali 38	
Vrtno kladivo	HR5212C, HR5202C, HR4001C, HR4002, HR4501C, HR4511C, HR4013C, HR4003C, HR3541C, DHR400, HR005G, HR006G	199143-4 (brez cevi)	Cev ø28 direktno
		samo za dletenje 199144-2 (s cevjo)	Prikljček 24 ali 38

	Model	Odsevalni nastavek	Velikost priključka
Vrtno kladivo	HR140D, HR166D, DHR165, DHR171, DHR182, DHR202, DHR263, HR1840, HR2470, HR2800, HR2810, HR2810T, HR2811FT	samo za vrtnanje	193472-7 Prikljček 22
		*HR140D, *HR166D, *DHR165, *DHR171, *DHR182, *DHR202, *DHR241, *HR1840, DHR263, HR2470, HR2800, HR2810 *uporabi z 194581-5	198362-9 Prikljček 22
		DHR280, HR001G, HR003G, HR007G, HR2300, HR2630, HR2631F, HR2641, HR2651, HR2652, HR2653, HR3001C, HR3011F	195173-3 Prikljček 22
		DHR243, DHR283, HR002G, HR004G, HR2320T, HR2630T, HR2631FT, HR2653T, HR3012F	195179-1 Prikljček 22
		DHR400, HR005G, HR4013C, HR4003C	197148-8 Prikljček 22
	HR5212C, HR5202C	vrtnanje/dletenje	196858-4 Prikljček 22
		HR4001C, HR4002, HR4010C, HR4501C, HR4510C, HR4511C, vrtnanje/dletenje	195866-2 Prikljček 22
		DHR400, HR4013C, HR4003C, vrtnanje/dletenje	199142-6 Prikljček 22



## Za model Tip sesalnih sistemov

### Ročne in potopne krožne žage



Šoba za prah + Prikluček



Prikluček



Prikluček 22 ali 38

 Adapter 24 + Spojka za cev 192349-3 ali Adapter 24\*  
 \*ni potreben prikluček 24

Model	Odsesovalni nastavek	Velikost priključka
DHS630	1 194314-8	Prikluček 22
DHS660, DHS661	1 199230-9	Prikluček 24
DHS680	1 196961-1	Prikluček 24
DHS710	1 196520-1	Prikluček 24
DHS782, DHS783	1 196520-1	Prikluček 24
DSS610	1 419283-5	Prikluček 22
5008MG	1 194489-3	Prikluček 38
5103R	1 415426-7 (brez vijaka) 192419-8 (2x vijak)	Prikluček 38
5104S	1 450316-7	Prikluček 38
5143R	1 192490-2	Prikluček 38
N5900B	1 193068-4	Prikluček 38
5903R	1 192419-8	Prikluček 38
HS0036/HS0046	1 196520-1	Prikluček 24
HS301D, HS300D	1 195334-5	Prikluček 22
HS0600	1 198263-1	Prikluček 24
HS6100, HS6101	1 453289-3	Prikluček 24
HS6601	1 196520-1	Prikluček 24
HS7010	1 196520-1	Prikluček 24
HS7100, HS7101	1 453289-3	Prikluček 24
HS7611	1 196520-1	Prikluček 24
HS7601, HS7611	1 196520-1	Prikluček 24
DHS900, DSP600, DSP601	2 ---	Prikluček 24
RS001G	2 ---	Prikluček 24
RS002G, 5017RKB	2 ---	Prikluček 38
DSP600, DSP601, SP6000, SP0001G	2 ---	Prikluček 24
HS0096, HS011G	2 ---	Prikluček 24

## Za model Tip sesalnih sistemov

### Kotne brusilke z diamantno rezalno ploščo



Prikluček 22 ali 38



Adapter 24



































Model	Odsesovalni nastavek	Velikost priključka
115/125 mm modeli s tremi priklonimi utori	3 196845-3	Prikluček 38
115/125 mm modeli z enim priklonim utorom	1 198415-4	Prikluček 38
	2 192968-5 (s spojko) 192972-4 (brez spojke)	Prikluček 38
	3 196846-1	Prikluček 38
125 mm X-Lock modeli	3 191605-4	Prikluček 38
125 mm modeli z zaščitnim pokrovom za namestitve brez orodja	3 191606-2	Prikluček 38
230 mm modeli s tremi priklonimi utori brez zavore motorja	4 198440-5	Prikluček 38
230 mm modeli z enim/dvema priklonima utoroma	2 194044-1	Prikluček 38

### Kotne brusilke z diamantno rezalno ploščo



Model	Odsesovalni nastavek	Velikost priključka
125 mm modeli z zaščitnim pokrovom za namestitve brez orodja	191F81-2	Prikluček 38
115/125 mm modeli s tremi priklonimi utori	195239-9	Prikluček 38
230 mm modeli s tremi priklonimi utori	195385-8	Prikluček 38

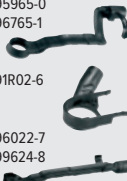









Za model		Tip sesalnih sistemov			
<b>Tračni brusilnik</b> 9032 <b>Aku. tračni brusilnik</b> DBS180 	<b>Spojka</b> 122652-8 	<b>A</b>  Prikluček 22	<b>Potopni rezalnik utorov za aluminij</b> CA5000 	<b>Prikluček 24</b> 195546-0 	<b>A</b>  Prikluček 22
<b>Tračni brusilnik</b> 9031 		<b>B</b>  Prikluček 22	<b>Aku. vbodna žaga</b> DJV180, DJV181, DJV182 <b>Vbodna žaga</b> 4350CT, 4350FCT, 4351CT, 4351FCT 	<b>Šoba za prah</b> 126331-0 	<b>B</b>  Prikluček 22
<b>Vibracijski brusilnik</b> 9046, BO3710, BO3711, BO4900V, BO4901, BO4555, BO4565, BO4557 <b>Aku. vibracijski brusilnik</b> DBO380, DBO381 		<b>C</b>  Adapter 22-38	<b>JV103D**, JV102D**</b> DJV184 	<b>457801-1</b> <b>+ Prikluček 24</b> 195546-0 	<b>C</b>  Adapter 22-38
<b>Ekscentrični brusilnik</b> BO5030, BO5031, BO5041, BO6030, BO6040 <b>Aku. ekscentrični brusilnik</b> DBO180 		<b>D</b>  Prikluček 22	<b>Vbodna žaga</b> JV100D, JV143D, 4326, 4327, 4329, JV0600 		<b>D</b>  Adapter 22-38
<b>Ekscentrični brusilnik</b> BO6050 	<b>Prikluček 24</b> 195546-0 	<b>E</b>  Adapter 24 + Spojka za cev 192349-3 ali Adapter 24* *ni potreben priključek 24	<b>Aku. vbodna žaga</b> DJV180, DJV181, DJV182 <b>Vbodna žaga</b> 4350CT, 4350FCT, 4351CT, 4351FCT 	<b>Šoba za odsesovanje prahu</b> 417853-4 	<b>E</b>  Adapter 24 + Spojka za cev 192349-3 ali Adapter 24* *ni potreben priključek 24
<b>Tračni brusilnik</b> 9404, 9903, 9910, 9911, 9920 		<b>F</b>  Adapter 38 + Spojka za cev 195548-6 ali Adapter 24* *ni potreben priključek 24	<b>Aku. ročna krožna žaga</b> DHS630 DSS611, DSS610 HS300D, HS301D 	<b>Šoba za prah</b> 194314-8 419283-5 195334-5 	<b>F</b>  Adapter 38 + Spojka za cev 195548-6 ali Adapter 24* *ni potreben priključek 24
<b>Aku. multifunkcijsko orodje</b> DTM50 DTM51  DTM52  <b>Multifunkcijsko orodje</b> TM3000C TM3010C 	<b>Šoba za prah</b> 195965-0 196765-1  191R02-6  196022-7 199624-8 		<b>Aku. brusilnik za stene</b> DSL800, DSL801 	<b>+ Prikluček 24</b> 195546-0 	

















**Za model** | **Tip sesalnih sistemov**

<p>Kotni rezalnik 4112HS</p> 	<p>Kolenska spojka 192613-2</p> 
<p>Diamantni rezalnik 4100KB Akumulatorski diamantni rezalnik DCC500</p> 	
<p>Diamantni rezalnik z odsesovanjem 4157KB</p> 	
<p>Rezalnik za zidne utore SG1251, SG1250</p> 	
<p>Brusilnik za beton PC5000C, PC5001C</p> 	
<p>Krtačni brusilnik 9741</p> 	<p>Spojka 410899-9</p> 







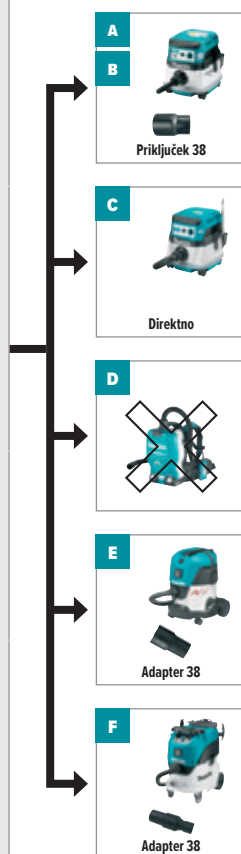

**Za model** | **Tip sesalnih sistemov**

<p>Akumulatorska stabilna kotna žaga DLS713, DLS714, DLS600 Stabilna in kotna žaga LS0714FL, LS0815FL, LS1016L, LS1018L, LS1216, LS1216L, LS1040</p> 	<p>A</p>  <p>B</p> 
<p>Stabilna in kotna žaga (flip sistem) LF1000</p> 	<p>C</p>  <p>D</p> 
<p>Stabilna in kotna žaga LH1040, LH1201FL</p> 	<p>E</p> 
<p>Stabilna in kotna žaga LS1019, LS1019L, LS1219L Aku. stabilna kotna žaga DLS111, DLS211, LS002G LS003G, LS004G</p> 	<p>+ Priključek 24 195546-0</p>  <p>F</p> 





Za model	Tip sesalnih sistemov
Namizna krožna žaga 2704N 	Spojka 419093-0 
Namizna krožna žaga 2712 	
Namizna krožna žaga MLT100N 	Spojka JM27000090 
Tračna žaga LB1200F 	Spojka 419093-0 

**A**



**B**



Priključek 38

**C**



Direktno

**D**



**E**











Adapter 38

**F**



Adapter 38

Za model	Tip sesalnih sistemov
Akumulatorski oblič DKP181, KP001G Oblič KP0810, KP0810C 	Kolenska cev ***191C20-4  <p>***Opcijska uporaba</p>
Akumulatorski oblič DKP180 Oblič KP0800 	Adapter za cev 451329-1 
Široki oblič 1911B 	Adapter za cev 192082-7 
Oblič N1923B, KP0800, 1806B, KP312S 	 + 

**A**



**B**



Priključek 38

**C**



Direktno

**D**



Priključek 38

**E**



Adapter 38

**F**



Adapter 38

Model	Koda	Model	Koda
N1923B	181572-5	N1923B	JPA122275
KP0800, DKP180	451329-1	DKP180, KP0810, KP0810C, KP0800	416368-8
1806B	122397-8	1806B, KP312S	181575-9
KP312S	193733-5		





**Za model**      **Tip sesalnih sistemov**

<p><b>Aku. lamelni rezkar</b> DPJ180 <b>Lamelni rezkar</b> PJ7000, 3901</p> 	
<p><b>Rotacijski rezalnik</b> 3706</p> 	<p><b>Šoba za prah</b> 193449-2</p> 
<p><b>Akumulatorski izrezovalnik</b> DC0180, DC0181</p> 	
<p><b>Akumulatorska žaga za suhomontažne plošče</b> DSD180, SD100D</p> 	
<p><b>Nadrezkar</b> RP0910, RP1100C RP1110C</p> 	

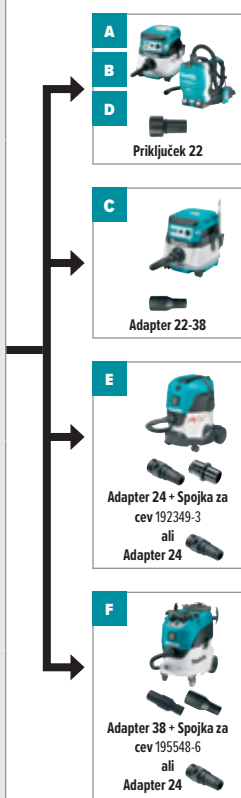

**Za model**      **Tip sesalnih sistemov**

<p><b>Nadrezkar</b> RP1801F, RP1800, RP1800F, RP1803F RP2301FC, RP2300FC, RP2303F</p> 	<p><b>Šoba za prah</b> 194934-8</p> 
<p><b>Nadrezkar</b> RP0900, ***RT0700C ***RT0702C</p> <p><b>Akumulatorski rezalnik</b> ***DRT50</p>  <p>***Uporabi s potopnim podnožjem</p>	<p><b>Šoba za prah</b> 194733-8</p> 
<p><b>Rezalnik</b> RT0700C</p> <p><b>Akumulatorski rezalnik</b> DRT50</p> 	<p><b>Šoba za prah</b> 195559-1</p> 

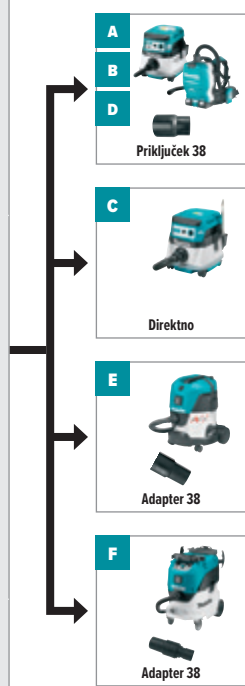

Makita pri uporabi nadrezkarjev in rezalnikov priporoča uporabo Ø38 mm cevi.



## PRIKLJUČKI IN ADAPTERJI

**Cev Ø28 mm**  
s priključkoma 22/38



**Zadni priključek**

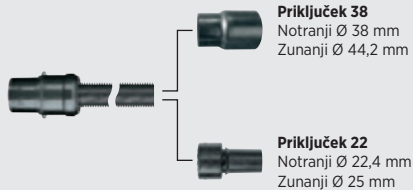

**Cev Ø38 mm**  
s priključkom 38



**Zadni priključek**

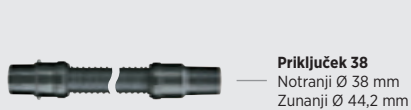

**Povezave priključkov 22, 38 in 24**

**Cev Ø28 mm**  
s priključkom 22



**Cev Ø28 mm**  
s priključkom 38



**Cev Ø38 mm**  
s priključkom 38



**Priključek 24**  
195546-0

+



**Povezave med cevmi**

Cev Ø28 mm/Priključek 38



Cev Ø28 mm/Zadni priključek



Cev Ø38 mm/Priključek 38



Cev Ø38 mm/Zadni priključek



**Povezave adapterja 22-38**

Cev Ø28 mm/Priključek 38



+



**Adapter 22-38**  
Notranji Ø 38 mm  
Zunanji Ø 44,2 mm



## ZA ODESAVANJE PRAHU

**Model**  
DVC150L / DVC152L  
DVC155L / DVC157L  
DVC860L / DVC862L  
DVC864L  
DVC865L  
DVC867L  
VC001GL  
VC003GL  
VC005GL



**Model**  
DVC260 / DVC261  
DVC660 / DVC265  
VC008G / VC009G



**Model**  
VC3211H  
VC3211M  
VC2211M  
VC3210L



**Model**  
DVC750L



**Model**  
VC2000L  
VC2012L  
VC2512L  
VC3011L



**Model**  
VC3012L  
VC4210L  
VC4210M



**Cev Ø28 mm**

\*143787-2 (1,0 m)  
direktna povezava  
A-34235 (1,5 m)  
priključek 22, 38  
195433-3 (3,5 m)  
priključek 22, 24, 38



\*primerno za modele  
DVC260, DVC261, DVC660,  
DVC265, VC008G, VC009G

**Cev Ø38 mm**

195434-1 (2,5 m)  
priključek 38



**Cev Ø32 mm**

P-81739 (3,5 m)



**Cev Ø32 mm**

P-84084 (4 m)



**Priključek**



**Adapter**



**Adapter**



**Adapter**



**Nastavki**

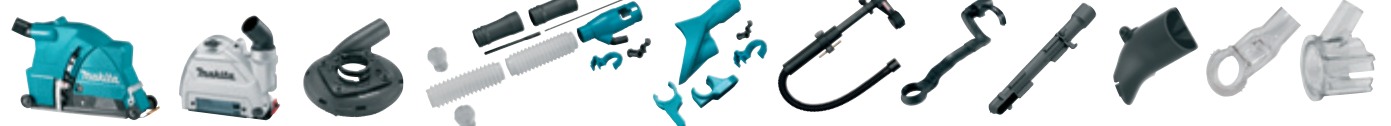



## A Gibljive cevi

Koda	Opis	Dožina	Premer	Priključki	Model sesalnika							
					VC2000L	VC2012L	VC2512L	VC3011L	VC3012L	VC4210L	VC4210M	
1	P-70362 ● ⚡	Plastična z zaklepom in vrtljivim priklpom za sesalnik	3,0 m	36						✓	✓	✓
2	P-70487 ● ⚡	Plastična z vrtljivim priklpom za sesalnik	3,5 m	27	24					✓	✓	✓
3	P-84084 ● ⚡	Plastična z zaklepom in vrtljivim priklpom za sesalnik	4,0 m	32	32B					P	P	P
4	P-81739 ●	Plastična z zaklepom in priloženo ukrivljeno cevjo	3,5 m	32	32B	P	P	P	P			

⚡: antistatična P: priloženo ✓: opsijsko

## B Ukrivljene cevi in seti

Koda	Opis	1	2	3	4
		P-70362	P-70487	P-84084	P-81739
5	P-70346 ●	Iz nerjavnega jekla	✓	✓	✓
6	W107413340 ●	Plastična z zaklepom			✓
7	W107418349 ●	Set za čiščenje vsebuje P-70346 ukrivljeno cev, W107418350 ravne cevi, P-81789 talno krtačo in W6084 ozki nastavek	✓	✓	✓

## C Ravne cevi

Koda	Opis	5	6
		P-70346	W107413340
8	P-70437 ●	Set 2 kosov 505 mm iz nerjavnega jekla	✓
9	W107418350 ●	Set 3 kosov 350 mm iz nerjavnega jekla	✓
10	P-72942 ●	Set 2 kosov 520 mm iz jekla	✓

## D Sesalni nastavi

Tip nastavka	Opis	8	9	10
		P-70437	W107418350	P-72942
P-81789	Talna krtača za suho in mokro čiščenje, 300 mm	✓	✓	
W107402706	Talna krtača za suho in mokro čiščenje, 260 mm			✓
W14295	Univerzalni sesalni nastavek za suho in mokro čiščenje, 120 mm			✓
W29541	Ozki nastavek, 200 mm*			✓
W6084	Ozki nastavek, 300 mm	✓	✓	

\*Uporabiti z P-81745 adapterjem z regulacijo



## A Gibljive cevi

Koda	Opis	Dolžina	Premer	Priključki	Model sesalnika										
					VC2211M	VC3210L	VC3211H	VC3211M	DVC150L	DVC152L	DVC155L	DVC860L	DVC865L	DVC867L	
1	144408-9	● (☒)	Plastična	1,5 m	28		✓	✓	✓	✓	✓	✓	✓	✓	✓
2	152992-0	● (☒)	Plastična	1,5 m	28	38	✓	✓	✓	✓	✓	✓	✓	✓	✓
3	A-34235	● (☒)	Plastična	1,5 m	28	22/38	✓	✓	✓	✓	✓	✓	✓	✓	✓
4	195433-3	● (☒)	Plastična	3,5 m	28	22/24/38	✓	P	✓	✓	✓	✓	✓	✓	✓
5	191G76-1	● (☒)	Plastična ojačana z najlonsko mrežico	5,0 m	28	22/24/38	✓	✓	✓	✓	✓	✓	✓	✓	✓
6	199493-7	● (☒)	Plastična ojačana z zaklepom	1,7 m	32	32A	✓	✓	✓	✓	✓	P	✓	P	✓
7	195434-1	● (☒)	Plastična	2,5 m	38	38	P	P	P	P	P	✓	P	✓	p

☒: antistatična P: priloženo ✓: opcijsko

## B Ukrivljene cevi

Koda	Opis	1	2	3	4	5	6	7
		144408-9	152992-0	A-34235	195433-3	191G76-1	199493-7	195434-1
8	126756-8	●	Plastična z vrtljivim priklpom	✓	✓	✓	✓	✓
9	127093-3	●	Plastična z vrtljivim priklpom in zaklepom	✓	✓	✓	✓	✓
10	458184-2	●	Plastična				✓	
11	140G26-3	●	Plastična z zaklepom					✓
12	192562-3	●	Aluminijasta	✓	✓	✓	✓	✓

## C Ravne cevi

Koda	Opis	8	9	10	11	12
		126756-8	127093-3	458184-2	140G26-3	192562-3
13	191D80-2	●	320 mm plastična	✓	✓	
14	451241-5	○	465 mm plastična	✓	✓	
15	451244-9	●		✓	✓	
16	456587-4	●		✓	✓	
17	198559-0	○		500-850 mm plastična	✓	✓
18	199844-4	●	465 mm aluminijasta	Uporabi kot komplet	✓	
19	199843-6	●	465 mm aluminijasta		✓	
20	191D76-3	○	340 mm plastična z zaklepom	✓	✓	✓
21	191D77-1	●		✓	✓	✓
22	191D78-9	●		✓	✓	✓
23	459356-2	●	480 mm plastična z zaklepom	✓	✓	✓
24	140G19-0	●	590-942 mm aluminijasta z zaklepom	✓	✓	
25	192563-1	●	565 mm aluminijasta			✓

## D Sesalni nastavki

Tip nastavka	13	14	15	16	17	18	19	20	21	22	23	24	25
	191D80-2	451241-5	451244-9	456587-4	198559-0	199844-4	199843-6	191D76-3	191D77-1	191D78-9	459356-2	140G19-0	192563-1
28 nastavki	✓	✓	✓	✓	✓			✓	✓	✓	✓	✓	
32 nastavki						✓	✓						
38 nastavki													✓



- Akumulat orji in polnilniki
- Pribor za akumulat orsko orodje
- Akumulat orske svetilke in pribor
- Pribor za lasarske merilnike
- Pribor za rušenje in vrtanje
- Pribor za vrtanje
- Kronske žage
- Pribor za vijačenje
- Pribor za rezanje in brušenje
- Pribor za poliranje in brušenje
- Pribor za rezkanje in oblanje
- Pribor za multifunkcijsko orodje
- Pribor za žaganje
- Pribor za žebjalnike in spenjalnike
- Pribor za fene
- Pribor za sesanje
- Pribor orodja za uporabo na prostem
- Pribor za nošenje orodja za zaščita oprema
- Kovčki in torbe za orodje
- Ročno orodje
- Razno
- Pribor za mešanje

## A Gibljive cevi

Koda	Opis	Dolžina	Premer	Priključki	Model sesalnika				
					DVC260	DVC261	DVC265	DVC660	
1	143787-2 ● ⚡	Plastična	1,0 m	28		P	P	✓	✓
2	144408-9 ● ⚡	Plastična	1,5 m	28		✓	✓	✓	✓
3	152992-0 ● ⚡	Plastična	1,5 m	28	38	✓	✓	✓	✓
4	A-34235 ● ⚡	Plastična	1,5 m	28	22/38	✓	✓	P	✓
5	140F62-3 ●	Plastična ojačana z zaklepom	1,0 m	32	32A	✓	✓	✓	P
6	199493-7 ●	Plastična ojačana z zaklepom	1,7 m	32	32A	✓	✓	✓	✓

⚡ antistatična P: priloženo ✓: opcijso

## B Ukrivljene cevi

Koda	Opis	1	2	3	4	5	6
		143787-2	144408-9	152992-0	A-34235	140F62-3	199493-7
7	126756-8 ● Plastična z vrtljivim priklpom	✓	✓	✓	✓		
8	127093-3 ● Plastična z vrtljivim priklpom in zaklepom	✓	✓	✓	✓		
9	458184-2 ● Plastična					✓	✓
10	140G26-3 ● Plastična z zaklepom					✓	✓
11	192562-3 ● Aluminijasta			✓	✓		

## C Ciklonski nastavki in ravne cevi

Koda	Opis	7	8	9	10	11
		126756-8	127093-3	458184-2	140G26-3	192562-3
12	191D75-5 ● Ciklonski nastavek	✓		✓		
13	191D80-2 ● 320 mm plastična za ciklonski nastavek	✓		✓		
14	451241-5 ○			✓		
15	451244-9 ● 465 mm plastična	✓		✓		
16	456587-4 ●	✓		✓		
17	198559-0 ○ 500-850 mm plastična	✓		✓		
18	199844-4 ● 465 mm aluminijasta	✓		✓		
19	199843-6 ● 465 mm aluminijasta	✓		✓		
20	191D73-9 ● Ciklonski nastavek z zaklepom		✓		✓	
21	191D76-3 ○		✓		✓	
22	191D77-1 ● 340 mm plastična z zaklepom za ciklonski nastavek		✓		✓	
23	191D78-9 ●		✓		✓	
24	459356-2 ● 480 mm plastična z zaklepom		✓		✓	
25	140G19-0 ● 590-942 mm aluminijasta z zaklepom		✓		✓	
26	192563-1 ● 565 mm aluminijasta					✓

## D Sesalni nastavki

Tip nastavka	13	14	15	16	17	18	19	21	22	23	24	25	26
	191D80-2	451241-5	451244-9	456587-4	198559-0	199844-4	199843-6	191D76-3	191D77-1	191D78-9	459356-2	140G19-0	192563-1
28 nastavki	✓	✓	✓	✓	✓			✓	✓	✓	✓	✓	
32 nastavki						✓	✓						
38 nastavki													✓





## 28 nastavki

Koda	Naziv	
127082-8	Tanek sesalni nastavek, 285 mm	
191G86-8	Sesalni nastavek za tla in preproge z gumbom, 320 mm	
198532-0	Sesalni nastavek za tla in preproge z gumbom, 320 mm	
123486-2	Sesalni nastavek za tla, 220 mm	
123488-8		
123539-7		
198528-1		
198527-3	Sesalni nastavek za preproge, 220 mm	
198529-9		
198528-1		
199038-1	Nastavek za sesanje sedežev, 180 mm	
199041-2		
199039-9		
191M30-1	Krtača za prah, 165 mm	
451240-7	Ozki nastavek, 160 mm	
451243-1		
456586-6		
413770-6	Ozki nastavek, 160 mm	
413859-0		
413809-5		
198919-6	Nastavek za sesanje v kotih, 330 mm	
198990-0		
198992-6		
199439-3	Ozki nastavek, 415 mm	
140H95-0	Nastavek za sedeže, 120 mm	
127825-8	Sesalni nastavek za tla, 220 mm	
127827-4		
459056-4	Sesalni nastavek za preproge, 120 mm	
198878-4	Okrogla krtača, 120x60 mm	
198553-2		
198555-8		
198873-4	Sesalni nastavek s krtačo, 180 mm	
198538-8		
198540-1		
140H94-2		Mehka krtača, 360 mm
422437-5	Gumiran nastavek, 330 mm	
197901-2	Ozki gumiran nastavek, 155 mm	
122234-6	Sesalni nastavek, 225 mm	

## 32 nastavki

Koda	Naziv	
P-81789	Talna krtača za suho in mokro čiščenje, 300 mm	
W107402706	Talna krtača za suho in mokro čiščenje, 260 mm	
W14295	Univerzalni sesalni nastavek za suho in mokro čiščenje, 120 mm	
W29541	Ozki nastavek, 200 mm*	
W6084	Ozki nastavek, 300 mm	



































\*Uporabi z P-81745 adapterjem z regulacijo

## 38 nastavki

Koda	Naziv	
127083-6	Tanek sesalni nastavek, 285 mm	
198533-8	Sesalni nastavek za tla in preproge z gumbom za suho čiščenje, 320 mm	
195551-7	Sesalni nastavek za suho in mokro čiščenje, 320 mm	
191G87-6	Sesalni nastavek za tla in preproge z gumbom, 320 mm	
195549-4	Sesalni nastavek za suho čiščenje, 210 mm	
195550-9	Sesalni nastavek za mokro čiščenje, 210 mm	
191657-9	Okrogla krtača, 130x60 mm	
410306-2	Ozki nastavek, 330 mm	
458891-7	Sesalni nastavek, 130 mm	

- Akumulat orji in polnilniki
- Pribor za akumulat orsko orodje
- Akumulat orske svetilke in pribor
- Pribor za lasarske mlinčke
- Pribor za rušenje in vrtnje
- Pribor za vrtnje
- Kronske žage
- Pribor za vijčenje
- Pribor za rezanje in brušenje
- Pribor za poliranje in brušenje
- Pribor za rezkanje in oblanje
- Pribor za multifunkcijsko orodje
- Pribor za žaganje
- Pribor za žebjalnike in spenjalnike
- Pribor za fene
- Pribor za sesanje
- Pribor za ročno orodje na prostem
- Pribor za ročno orodje za zaščito oprema
- Kovčki in torbe za orodje
- Ročno orodje
- Razno
- Pribor za mešanje

## Filtri

	Suho	Suho/mokro	Suho/mokro	Suho/mokro	Suho/mokro	Suho/mokro
	DVC156L DVC157L DVC861L DVC866L DVC867L	DVC155L DVC865L DVC860L	VC3211H VC3211M VC2211M	VC3210L	VC001GL VC003GL	VC002GL VC004GL VC005GL
						
Uporabi kot set	<b>Filter prahu</b>	 197166-6*	 VC3211H: 196251-2* VC3211M, VC2211M: 196252-0*	 195441-4	 191V70-3*	 191V70-3*
	<b>Filter iz pene</b>	 195552-5	 196254-6	 195552-5	 191V68-0	 191V68-0
	<b>Predfilter</b>	 195553-3	 196253-8	 195612-3	 191V69-8	 191V69-8
	<b>Tkani filter</b> Suho in mokro čiščenje	 140248-3			 144625-1	 144625-1, 191V71-1 (samo za VC005G)
	<b>Vodni filter</b> Samo mokro čiščenje Pri sesanju velike količine vode je priporočljivo uporabiti vodni filter.	 195555-9 (samo za DVC155L, DVC865L, DVC860L)		 195611-5	 191V67-2	
	<b>Vrečka za prah 15L</b> (za suho čiščenje)	 195557-5				
	<b>Vrečka za prah 25L</b> (za suho čiščenje)		 195558-3	 195558-3		
	<b>Plastična vrečka za sesanje</b>	 195432-5	 195440-6	 195440-6	 195432-5	 195432-5



## Za suho čiščenje

- Filter prahu
- Filter iz pene
- Predfilter
- Papirnata ali plastična vrečka za prah

## Za suho in mokro čiščenje

- Tkani ali vodni filter (mokro čiščenje)

## Zdržljivost s plastičnimi vrečkami

- Omogoča hitro in enostavno praznjenje
- Nižji stroški v primerjavi s papirnatimi vrečkami



## Filtri









### Filtri

Koda	Naziv	Za model	Cena z DDV	
127725-2	Zračni HEPA filter	DVC260		
140248-3	Filter iz blaga	DVC150L, DVC155L, DVC865L, DVC860L		
144625-1	Filter iz klobučevine	VC001G, VC003G, VC004G		
162518-0	Zračni filter za DVC750	DVC750		
162635-6	Predfilter	DVC750		
191E39-5	HEPA filter DVC560Z	DVC560		
191G88-4	Tkani filter za prah	DVC866L, DVC156L		
191M39-3	Filter iz pene za mokro sesanje	DVC750		
191V67-2	Vodni filter	VC001G, VC003G		
191V68-0	Filter iz pene	VC004G		
191V69-8	Predfilter	VC004G		
191V70-3	Filter	VC004G		

[Nadaljevanje...](#)

- Akumulat orji in polnilniki
- Pribor za akumulat orsko orodje
- Akumulat orske svetilke in pribor
- Pribor za laserske merilnike
- Pribor za rušenje in vrtanje
- Pribor za vrtanje
- Kronске žage
- Pribor za vijačenje
- Pribor za rezanje in brušenje
- Pribor za poliranje in brušenje
- Pribor za rezkanje in oblanje
- Pribor za multitfunkcijsko orodje
- Pribor za žaganje
- Pribor za žebjalnike in spenjalnike
- Pribor za fene
- Pribor za sesanje**
- Pribor za ročno orodje in zaščitna oprema
- Kovčki in torbe za orodje
- Ročno orodje
- Razno
- Pribor za mešanje

# Pribor za sesanje

	Koda	Naziv	Za model	Cena z DDV
Akumulat orji in polnilniki				
Pribor za akumulat orsko orodje				
Akumulat orske svetilke in pribor				
Pribor za lasarske mehanike				
Pribor za rušenje in vrtnanje				
Pribor za vrtnanje				
Kronske žage				
Pribor za vijačenje				
Pribor za rezanje in brušenje				
Pribor za poliranje in brušenje				
Pribor za rezkanje in oblanje				
Pribor za multitank ciklo orodje				
Pribor za žaganje				
Pribor za žebjalnike in spenjalnike				
Pribor za fene				
<b>Pribor za sesanje</b>				
Pribor orodja za uporabo na prostem				
Pribor za nošenje orodja in zaščitna oprema				
Kovčki in torbe za orodje				
Ročno orodje				
Razno				
Pribor za mešanje				
	191V71-1	Tekstilni filter	VC005G	
	195441-4	Filter	VC2510L, VC3210L	
	195552-5	Filter iz pene	DVC150L, DVC155L, DVC865L, DVC860L, DVC151L, DVC156L, DVC157L, DVC861L, DVC866L, DVC867L, VC3210L, VC2510L, VC1310L	
	195553-3	Prefilter	DVC150L, DVC155L, DVC865L, DVC860L, DVC151L, DVC156L, DVC157L, DVC861L, DVC866L, DVC867L, VC1310L	
	195555-9	Filter sesalnika (za vodo)	DVC150L, DVC155L, DVC865L, DVC860L, VC1310L	
	195611-5	Filter sesalnika	VC3210L	
	195612-3	Prefilter	VC3210L	
	196251-2	Filter za prah H	VC3211H	
	196252-0	Filter za prah M	VC3211M, VC2211M, VC2201M	
	196253-8	Prefilter	VC3211H, VC3211M, VC2211M, VC2201M	
	196254-6	Filter iz pene	VC3211H, VC3211M, VC2211M, VC2201M	
	197166-6	HEPA filter	DVC150L, DVC155L, DVC865L, DVC860L, DVC151L, DVC156L, DVC157L, DVC861L, DVC866L, DVC867L	
	199827-4	Set predfiltrov	DVC750	

[Nadaljevanje...](#)

# Pribor za sesanje

Koda	Naziv	Za model	Cena z DDV	
199966-0	Filter, enostavno čistljiv	DCL281F, DCL280F, DCL181F, DCL180F, DCL180, CL183D, CL111D, CL106FD, CL070D		
199989-8	Hepa filter	DCL281F, DCL280F, DCL181F, DCL180F, DCL180, CL183D, CL111D, CL106FD		
422268-2	Protiprašna zaščita 57 za sesalnike	DCL281F, DCL280F, DCL180, CL111D, CL106FD, CL100D, CL108FD		
422449-8	Filter iz pene	DVC750		
443060-3	Filter iz blaga	DCL281F, DCL280F, DCL181F, DCL180F, DCL180, CL183D, CL111D, CL106FD, CL070D		
451208-3	Predfilter	DCL281F, DCL280F, DCL181F, DCL180F, DCL180, CL183D, CL111D, CL106FD, CL070D, CL001G		
83035BHB	Filter iz pene za mokro sesanje	440, 448, 445X		
83035H0B	Filter iz pene za mokro sesanje	449		
83140H0G	Filtrski vložek	449		
P-70219	Filtrski vložek	VC3012M/L, VC2512L, VC3011L, VC2000L		
P-70225	Filtrski vložek	447L, 447M		
W107418351	Filter PTFE	VC4210L/M		
W107418352	Filter motorni	VC4210L/M		

Nadaljevanje...

- Akumulat orji in polnilniki
- Pribor za akumulat orske orodje
- Akumulat orske svetilke in pribor
- Pribor za lasarske mehanike
- Pribor za rušenje in vrtanje
- Pribor za vrtanje
- Kronske žage
- Pribor za vijačenje
- Pribor za rezanje in brušenje
- Pribor za poliranje in brušenje
- Pribor za rezkanje in oblanje
- Pribor za multitfunkcijsko orodje
- Pribor za žaganje
- Pribor za žebjalnike in spenjalnike
- Pribor za fene
- Pribor za sesanje**
- Pribor orodja za uporabo na prostem
- Pribor za čiščenje in zaščitna oprema
- Kovčki in torbe za orodje
- Ročno orodje
- Razno
- Pribor za mešanje











# Pribor za sesanje

	Koda	Naziv	Za model	Cena z DDV
	W29747	Filterjski vložek	442, 443	
	W302000525	Filter iz blaga	447L	
	W302000606	Filter iz blaga	446L	

## Vrečke za prah

### Vrečke za prah na orodju

	Koda	Naziv	Za model	Enota (kos/set)	Cena z DDV
	122296-4	Vrečka za prah	9924DB, 9900B	1	
	122297-2	Vrečka za prah	9401, 9402	1	
	122329-5	Vrečka za prah	9901	1	
	122330-0	Vrečka za prah	LS1440	1	
	122469-9	Vrečka za prah	1050D, 1051D	1	
	122474-6	Vrečka za prah	3901	1	
	122548-3	Vrečka za prah	9910, 9911	1	
	122562-9	Vrečka za prah	9403	1	

[Nadaljevanje...](#)











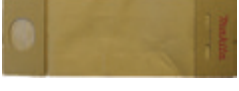

# Pribor za sesanje

Koda	Naziv	Za model	Enota (kos/set)	Cena z DDV	
122591-2	Vrečka za prah	9404, 9920, 9903	1		
122708-7	Vrečka za prah	HR2432	1		
122793-0	Vrečka za prah	KP0810, KP0810C, KP0800, BKP180, DKP180	1		
122852-0	Vrečka za prah	DLS713, LS1016, LS1016L, LS1216, LS1216L, LH1040, LH1040F, LS1018, DLS211, LS003G	1		
122853-8	Vrečka za prah	PC5000C, PC5001C	1		
122884-7	Vrečka za prah	DLS600	1		
123150-5	Vrečka za prah	PJ7000	1		
123185-6	Vrečka za prah	4105KB	1		
123328-0	Vrečka za prah	M9400	1		
126599-8	Vrečka za prah	DSP600, DSP601	1		
126738-0	Vrečka za prah	4100KB, DCC500	1		
135132-5	Vrečka za prah	MT941	1		
135222-4	Vrečka za prah	BO4555, BO4556, BO4565, BO4566, MT924	1		
135246-0	Držalo s papirnato vrečko	DBO140, DBO180, BO4555, BO4556, BO4557, BO4558, BO4565, BO4566, BO5030, BO5031, BO5040, BO5041	1		

[Nadaljevanje...](#)













- Akumulat orji in polnilniki
- Pribor za akumulat orsko orodje
- Akumulat orske svetilke in pribor
- Pribor za lasarske merilnike
- Pribor za rušenje in vrtanje
- Pribor za vrtanje
- Kronske žage
- Pribor za vijačenje
- Pribor za rezanje in brušenje
- Pribor za poliranje in brušenje
- Pribor za rezkanje in oblanje
- Pribor za multitank ciljsko orodje
- Pribor za žaganje
- Pribor za žebjalnike in spenjalnike
- Pribor za fene
- Pribor za sesanje
- Pribor orodja za uporabo na prostem
- Pribor za hroščje orodja in zaščitna oprema
- Kovčki in torbe za orodje
- Ročno orodje
- Razno
- Pribor za mešanje

# Pribor za sesanje

	Koda	Naziv	Za model	Enota (kos/set)	Cena z DDV
	136402-5	Vrečka za prah	M9204	1	
	140115-2	Vrečka za prah	BO3710, BO3711	1	
	168557-8	Vrečka za prah	BO3710, BO3711	1	
	191C21-2	Vrečka za prah	DKP181, KP001G	1	
	193293-7	Papirnata vrečka za prah	9046,BO6030, BO5020, BO5021, BO3700, BO4900V	5/1	
	193294-5	Držalo za papirnato vrečko za prah	9046, BO3700, BO4900V, BO6030, BO5021	2/1	
	193712-3	Papirnata vrečka za prah	BO4553, BO4554, BO4561, BO4563, BO5011, BO5011, BO5012, BO5010, BO5011	5/1	
	194175-6	Ciklonski zbiralnik prahu	LS0714, LS0714F, LS0714FL, LS0814FL, LS1216, LS1216FL, LS1216L	1	
	194746-9	Papirnata vrečka za prah	BO4565, BO4555, BO4557, BO3700, BO3710, BO3711, BO5030, BO5031, BO5041, BBO180	5/1	
	196299-4	Vrečka za prah	N1923B	1	
	196300-5	Vrečka za prah	1911B	1	
	JM23100501	Vrečka za prah	LS1018L, LH1200FL	1	
	STEX122269	Vrečka za prah	1902	1	

# Pribor za sesanje

## Vrečke za sesalnike

Koda	Naziv	Za model	Enota (kos/set)	Gena z DDV	
122918-6	Vrečka za prah	DVC340, DVC350	1		
143677-9	Nosilec vrečke z loputo CL sesalniki	DCL182, DCL182F, CL121D, CL107FD, CL105D, CL104D, CL072D, CL121D	1		
161471-7	Papirnata filter vrečka	VC008G	1		
1910M4-5	Vrečka za prah	CL002G	1		
191C26-2	Vrečka za prah	DVC660, DVC665	10/1		
191C30-1	Vrečka za prah	DVC660, DVC665	1/1		
191D63-2	Vrečka za prah	DVC560	10/1		
192632-8	Papirnata vrečka za prah	4072D, 4073D, 4013D, 4093D, CL102D, CL104D, CL107FD, DCL142, DCL182, DCL184, CL002G	5/1		
195432-5	Plastična vrečka za sesalnik	DVC150L, DVC151L, DVC155L, DVC156L, DVC157L, DVC860L, DVC861L, DVC865L, DVC866L, DVC867L, VC1310L, VC001G, VC003G, VC004G, VC005G	10/1		
195440-6	Plastična vrečka za sesalnik	VC2510L, VC3210L, VC3211H, VC3211M, VC2211M	10/1		
195557-5	Filter vrečka	DVC150L DVC151L DVC155L DVC156L DVC157L DVC860L DVC861L DVC865L DVC866L DVC867L VC1310L VC2510L, VC001G, VC003, VC004G, VC005G	5/1		
195558-3	Filter vrečka	VC3210L, VC3211H, VC3211M, VC2211M	5/1		
197899-3	Tekstilna vrečka za prah	DVC260, DVC261, DVC265	1		

Nadaljevanje...

- Akumulat orji in pomliniki
- Pribor za akumulat orske orodje
- Akumulat orske svetilke in pribor
- Pribor za laserske merilnike
- Pribor za rušenje in vrtanje
- Pribor za vrtanje
- Kronske žage
- Pribor za vijačenje
- Pribor za rezanje in brušenje
- Pribor za poliranje in brušenje
- Pribor za rezkanje in oblanje
- Pribor za multitfunkcijsko orodje
- Pribor za žaganje
- Pribor za žebjalnike in spenjalnike
- Pribor za fene
- Pribor za sesanje
- Pribor za uporabo na prostem
- Pribor za ploščice in zaščitna oprema
- Kovčki in torbe za orodje
- Ročno orodje
- Razno
- Pribor za mešanje





# Pribor za sesanje

	Koda	Naziv	Za model	Enota (kos/set)	Cena z DDV
	197903-8	Filter vreča	DVC260, DVC261, DVC265	10/1	
	198747-9	Vrečka za prah	DCL282F, DCL182, DCL182F, CL121D, CL107FD, CL105D, CL104D, CL072D, CL121D, DCL184, CL002G	1	
	198749-5	Vrečka za prah	DCL282F, DCL182, DCL182F, CL121D, CL107FD, CL105D, CL104D, CL072D, CL121D, CL002G	1	
	198753-4	Vrečka za prah, enostavno čistljiva	CL107DF, DCL181	1	
	83132B8I	Papirnata filter vrečka, 20 l	440	5/1	
	83133B8K	Dvoslojna papirnata filter vrečka, 25 l	440	5/1	
	83134B8I	Papirnata filter vrečka	448	5/1	
	83139H0B	Plastična vrečka za sesalnik	449	5/1	
	P-70194	Papirnata filter vrečka	446L	5/1	
	P-70203	Papirnata filter vrečka	447L, 447M	5/1	
	P-70297	Plastična vrečka za sesalnik	446L, VC2012L, VC2512L, VC3011L, VC3012L/M, VC2010L, VC2511, VC3511L, VC2000L	5/1	
	P-70306	Plastična vrečka za sesalnik	447L, 447M	5/1	
	P-72899	Platnena vrečka za prah	VC2012L, VC2512L, VC3011L, VC2010L, VC2511, 446L, VC2000L	5/1	
	P-78293	Platnena vrečka za prah	VC3511L	5/1	

[Nadaljevanje...](#)



# Pribor za sesanje

Koda	Naziv	Za model	Enota (kos/set)	Cena z DDV	
P-84078	Platnena vrečka za prah	VC3012M / L, VC2512L, VC3011L	5/1		
W107418353	Filter vrečka - tekstilna	VC4210L/M	5/1		
W107418354	Filter vrečka - mikrofibra	VC4210L/M	1		
W107418355	Filter vrečka - plastična	VC4210L/M	5/1		
W28547	Papirnata filter vrečka	443	5/1		

- Akumulat orji in pomliniki
- Pribor za akumulat orsko orodje
- Akumulat orske svetilke in pribor
- Pribor za lasarske mešalnike
- Pribor za rušenje in vrtanje
- Pribor za vrtanje
- Kronske žage
- Pribor za vijačenje
- Pribor za rezanje in brušenje
- Pribor za poliranje in brušenje
- Pribor za rezkanje in oblanje
- Pribor za multitfunkcijsko orodje
- Pribor za žaganje
- Pribor za žebjalnike in spenjalnike
- Pribor za fene
- Pribor za sesanje**
- Pribor orodja za uporabo na prostem
- Pribor za nožna orodja in zaščitna oprema
- Kovčki in torbe za orodje
- Ročno orodje
- Razno
- Pribor za mešanje

# PRIBOR ORODJA ZA UPORABO NA PROSTEM



## Verižne žage

### Meči



Koda	Naziv	Dožina meča (mm)	Korak verige (")	Širina vodila verige (mm)	Število členov	Cena z DDV
161848-6	Meč z verižnikom	200	3/8	1,1	33	
161846-0	Meč z verižnikom	250	3/8	1,1	40	
165695-7	Meč z verižnikom	250	3/8	1,3	39	
168407-7	Meč za rezbarjenje	250	1/4	1,3	60	
168408-5	Meč z verižnikom	250	3/8	1,3	40	
191G22-4	Meč z verižnikom	250	3/8	1,3	40	
165200-0	Meč	300	3/8	1,3	46	
165245-8	Meč z verižnikom	300	3/8	1,1	46	
165201-8	Meč z verižnikom	350	3/8	1,3	52	
165246-6	Meč z verižnikom	350	3/8	1,1	52	
165456-5	Meč z verižnikom	350	3/8	1,3	52	
161420-4	Meč z verižnikom	380	0,325	1,3	64	
443038651	Meč z verižnikom	380	3/8	1,5	56	
445038631	Meč z verižnikom	380	0,325	1,5	64	
445038651	Meč z verižnikom	380	3/8	1,5	56	
445038655	Meč z verižnikom	380	3/8	1,5	60	
165202-6	Meč z verižnikom	400	3/8	1,3	56	
165247-4	Meč z verižnikom	400	3/8	1,1	56	
165390-9	Meč z verižnikom	450	3/8	1,3	62	
444045141	Meč z verižnikom	450	0,325	1,3	72	
445045651	Meč z verižnikom	450	3/8	1,5	64	
445045655	Meč z verižnikom	450	3/8	1,5	68	
445050655	Meč z verižnikom	500	3/8	1,5	72	
443053651	Meč z verižnikom	530	3/8	1,5	72	
445060455	Meč z verižnikom	600	3/8	1,5	84	
445070455	Meč s trdo konico	700	3/8	1,5	94	

### Verige



Koda	Dožina meča (mm)	Korak verige (")	Širina vodila verige (mm)	Število členov	Premer pile (mm)	Za model	Cena z DDV
791284-8	160	1/4	1,3	42	4,0-4,0	DUC121, DUC122	
199076-3	200	3/8	1,1	33		DUC254	
194098-8	250	1/4	1,3	60	4,0-4,0	DUC256C, DUC254C	
196142-7	250	3/8	1,3	39	4,0-4,0	EY2650H25H	
196205-9	250	3/8	1,3	40	4,0-4,0	DCS232T, DUC250, DUC302	
199075-5	250	3/8	1,1	40		DUC254, DUC256, DUC306, DUA301	
531291646	300	3/8	1,1	46	4,0-4,0	DUC302, UC3041A, DUC256, DUC306, DUA301	
531492646	300	3/8	1,3	46	4,0-4,0	UC3051A, UC3551A, UC4051A, UC4551A, EA3200S, EA3201S, EA3500S, EA3500F	
528086656	330	0,325	1,5	56	4,8-4,5	EA5000P, EA5001P	
531291652	350	3/8	1,1	52	4,0-4,0	DUC353, UC3541A	

[Nadaljevanje...](#)

 Akumulat  
orji in  
povlečki

 Pribor za  
akumulat  
orsko  
orodje

 Akumulat  
orske  
svetilke  
in pribor

 Pribor za  
lasarske  
merilnike

 Pribor za  
rušenje  
in vrtanje

 Pribor za  
vrtanje

 Kronske  
žage

 Pribor za  
vijačenje

 Pribor za  
rezanje  
in  
brušenje

 Pribor za  
poliranje  
in  
brušenje

 Pribor za  
rezkanje  
in  
oblanje

 Pribor za  
multifunk  
ciljsko  
orodje

 Pribor za  
žaganje

 Pribor za  
žebjalnike  
in  
spenjalnike

 Pribor za  
fene

 Pribor za  
sesanje

 Pribor  
orodja za  
uporabo  
na prostem

 Pribor za  
ploščne  
orodje in  
zaščitna  
oprema

 Kovčki in  
torbe za  
orodje

 Ročno  
orodje

Razno

 Pribor za  
mešanje

# Pribor orodja za uporabo na prostem

Koda	Dolžina meča (mm)	Korak verige (")	Širina vodila verige (mm)	Število členov	Premer pile (mm)	Za model	Cena z DDV
531492652	350	3/8	1,3	52	4,0-4,0	EA3200S, EA3201S, EA3500S, EA3500F, UC3051A, UC3551A, UC4051A, UC4551A	
528086664	380	0,325	1,5	64	4,8-4,5	DCS5121-45, EA5000P, EA5001P, EA5600F, EA6100P, EA6101P	
528099656	380	3/8	1,5	56	5,5-4,8	DCS5121-45, EA5000P, EA5001P, EA6100P, EA6101P	
532484064	380	0,325	1,3	64	4,8-4,5	EA4300F	
534686064	380	0,325	1,5	64	4,8-4,5	DCS5121-45, EA5000P, EA5001F, EA6100P, EA6101P	
196213-0	400	3/8	1,3	56	4,5-4,0	UC3541A, UC3051A, UC3551A, UC4051A, UC4551A, EA3200S, EA3201S, EA3501S, EA3502S, EA3600F, EA3601F, EA4300F	
531291656	400	3/8	1,1	56	4,0-4,0	UC4020A, UC4030A, UC4041A	
523093664	450	3/8	1,5	64	5,5-4,8	DCS5121-45, EA5000P, EA5001P, EA6100P, EA6101P, EA5600F	
528086672	450	0,325	1,5	72	4,8-4,5	DCS5121-45, EA5000P, EA5001F, EA6100P, EA6101P, EA5600F	
528099664	450	3/8	1,5	64	5,5-4,8	DCS5121-45, EA5000P, EA5001P, EA6100P, EA6101P	
531492662	450	3/8	1,3	62	4,0-4,0	UC3051A, UC3551A, UC4051A, UC4551A	
532484072	450	0,325	1,3	72	4,8-4,5	EA4300F, EA4301F	
534686072	450	0,325	1,5	72	4,8-4,5	DCS5121-45, EA5000P, EA5001F, EA6100P, EA6101P, EA5600F	
528099672	530	3/8	1,5	72	5,5-4,8	DCS5121-45, EA5000P, EA5600F, EA5001P, EA6100P, EA6101P, EA7300P, EA7900P	
528099680	600	3/8	1,5	80	5,5-4,8	DCS9010EA6100P, EA6101P	
528099684	600	3/8	1,5	84	5,5-4,8	DCS6400, EA6100P, EA6101P	



## Ščitniki za meč

Koda	Naziv	Dolžina meča (mm)	Cena z DDV
416311-7	Ščitnik za meč	160	
418845-6	Ščitnik za meč	250	
419242-9	Ščitnik za meč	400 - 450	
419288-5	Ščitnik za meč	300 - 350	
419559-0	Ščitnik za meč	300 - 350	
419560-5	Ščitnik za meč	350 - 450	
952020640	Ščitnik za meč	350 - 450	
952020650	Ščitnik za meč	450 - 530	
952020660	Ščitnik za meč	600	



# Pribor orodja za uporabo na prostem

291



















## Teleskopski podaljški za akumulatorske verižne žage

Koda	Naziv	Dimenzija (mm)	Opis	Za model	Gena z DDV	
195595-7	Teleskopski podaljšek	1.800x2.600	Primeren za BL1815N, BL1820B, BL1830B.	DUC122		

## Oprema za gozdarje

Koda	Naziv	Dolžina (mm)	Cena z DDV	
988070819	Plastična gozdarska zagozda	200		
988070824	Plastična gozdarska zagozda	250		

## Orodje za brušenje in vzdrževanje verig

Koda	Naziv	Enota (kos/set)	Cena z DDV	
744003-1	Pila	1		
950112031	Naprava za razstavljanje verige	1		
953003040	Okrogla pila brez ročaja 5,5 mm	1		
953004010	Ročaj za pilo, lesen	1		
953008020	Ročaj za pilo, plastični	1		
953009000	Držalo z vodilom za okroglo pilo 5,5 mm	1		
953030010	Držalo z vodilom za okroglo pilo 4 mm	1		
953030020	Držalo z vodilom za okroglo pilo 4,5 mm	1		
953030030	Držalo z vodilom za okroglo pilo 4,8 mm	1		
953030040	Vodilo za ročno brušenje	1		
D-67359	Okrogla pila brez ročaja 4,0 mm	2/1		
D-67371	Okrogla pila brez ročaja 4,5 mm	2/1		
D-67393	Okrogla pila brez ročaja 4,8 mm	2/1		
D-67402	Okrogla pila brez ročaja 4,8 mm	12/1		
D-67424	Okrogla pila brez ročaja 5,2 mm	12/1		
D-67430	Okrogla pila brez ročaja 5,5 mm	2/1		
D-67446	Okrogla pila brez ročaja 5,5 mm	12/1		
D-67452	Ploščata pila 15 mm	1		

Nadaljevanje...

Akumulat  
orji in  
poinliniki

Pribor za  
akumulat  
orsko  
svetilke  
in pribor

Akumulat  
orske  
svetilke  
in pribor

Pribor za  
laserske  
merilnike

Pribor za  
rušenje  
in vrtanje

Pribor za  
vrtanje

Kronske  
žage

Pribor za  
vijačenje

Pribor za  
rezanje  
in  
brušenje

Pribor za  
poliranje  
in  
brušenje

Pribor za  
rezkanje  
in  
oblanje

Pribor za  
multifunk  
ciljsko  
orodje

Pribor za  
žaganje

Pribor za  
žaganje  
in  
spenjalnike

Pribor za  
žebjalnike  
in  
spenjalnike

Pribor za  
fene

Pribor za  
sesanje

Pribor  
za  
uporabo  
na prostem

Pribor za  
ročno  
orodje  
in  
zaščitna  
oprema

Kovčki in  
torbe za  
orodje

Ročno  
orodje

Razno  
orodje

Pribor za  
mešanje



# Pribor orodja za uporabo na prostem

	Koda	Naziv	Enota (kos/set)	Cena z DDV
Akumulat orji in polnilniki	D-67474	Šablona za globino 143mm	1	
Pribor za akumulat orsko orodje	D-67480	Držalo za meč	1	
Akumulat orske svetilke in pribor	D-72154	Set za brušenje verige 4,0mm v torbici	1	
Pribor za lasarske merilnike	D-72160	Set za brušenje verige 4,5mm v torbici	1	
Pribor za rušenje in vrtanje	D-72176	Set za brušenje verige 4,8mm v torbici	1	
Pribor za vrtanje	D-72182	Set za brušenje verige 5,2mm v torbici	1	
Kronske žage	D-72198	Set za brušenje verige 5,5mm v torbici	1	
Pribor za vijachenje	D-73748	Pila 4.0mm	1	
Pribor za rezanje in brušenje	D-73754	Pila 4.5mm	1	
Pribor za poliranje in brušenje	D-73760	Pila 4.8mm	1	
Pribor za rezanje in oblanje	D-73776	Pila 5.2mm	1	
Pribor za multitank cijsko orodje	D-73782	Pila 5.5mm	1	
Pribor za žaganje				

## Olja in embalaža

	Koda	Naziv	Volumen (l)	Cena z DDV
Pribor za žebjalnike in spenjalnike	195532-1	Olje za 4-taktni motor, 10W-30	0,22	
Pribor za fene	197007-6	Olje za 4-taktni motor SL10W-40, 80ml	0,08	
Pribor za sesanje	980008606	Olje za 2-taktni motor	0,1	
Pribor za nosenje orodja in zaščita oprema	980008607	Olje za 2-taktni motor	1	
Kovčki in torbe za orodje				
Ročno orodje				
Razno				
Pribor za mešanje				

[Nadaljevanje...](#)

# Pribor orodja za uporabo na prostem

Koda	Naziv	Volumen (l)	Cena z DDV	
980008610	Biotop olje za verigo	1		
980008612	Olje za 2-taktni motor z merilno posodico	1		
980508620	Olje za 4-taktni motor, HD30	0,6		
988602656	Mineralno olje za verigo	1		
988602658	Mineralno olje za verigo	5		

Akumulat  
orj in  
pnilniki

Pribor za  
akumulat  
orsko  
orodje

Akumulat  
orske  
svetilke  
in pribor

Pribor za  
laserske  
merilnike







Pribor za  
rušenje  
in vrtnanje

Pribor za  
vrtnanje

Kronske  
žage

Pribor za  
vijačenje

## Kombinirane posode za gorivo

Koda	Naziv	Rezervoar za olje (l)	Rezervoar za gorivo (l)	Cena z DDV	
949000030	Kombinirana posoda za gorivo in olje, rdeča	3	5		
949000034	Kombinirana posoda za gorivo in olje, zelena	1,5	3,5		
949000035	Kombinirana posoda za gorivo in olje, bela	3	5		
949000036	Kombinirana posoda za gorivo in olje, transparentna	3	5		
949000050	Nastavek za dotakanje goriva in olja, navadni	/	/		
949100035	Nastavek za dotakanje olja z varnostno zaporo	/	/		
949100036	Nastavek za dotakanje goriva z varnostno zaporo	/	/		

Pribor za  
rezanje  
in  
brušenje

Pribor za  
poliranje  
in  
brušenje

Pribor za  
rezanje  
in  
oblanje

Pribor za  
multifunk  
ciljsko  
orodje

Pribor za  
žaganje

Pribor za  
žebjalnike  
in  
spenjalnike

Pribor za  
fene

Pribor za  
sesanje

Pribor  
orodja za  
uporabo  
na prostem

Pribor za  
prijem  
orodja in  
zaščitna  
oprema

Kovčki in  
torbe za  
orodje

Ročno  
orodje

Razno

Pribor za  
mešanje

# PRIBOR ZA MULTIFUNKCIJSKE GLAVE

## 191E24-8

Gred za podaljšanje  
LE400MP



## 191N39-9

Kosa  
EM408MP



## 191T38-7

Verižna žaga  
EY403MP

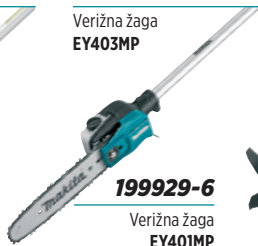

## 199183-2

Kultivator  
KR401MP



## 198062-1

Škarje za travo  
in živo mejo  
EN420MP



## 196257-0

Škarje za živo mejo  
EN401MP



## 199929-6

Verižna žaga  
EY401MP



## 197743-4

Ravne škarje  
za živo mejo  
EN410MP



## 196753-8

Nastavek za  
zaključevanje trate  
EE400MP



## 191M59-7

Rezalnik podrastja  
EM407MP



## 199341-0

Nastavek za pometanje  
SW400MP



## 199320-8

Nastavek za krtačenje  
BR400MP



## 191P76-5

Nastavek za pihanje  
UB401MP



## UX01 / DUX60 / DUX18

122906-3	Nahrbtni pas
125516-5	Ramenski pas
126012-6	Ramenski pas
195638-5	Torba za orodje

## EM408MP - kosa

198383-1	Rezilna glava s tremi plastičnimi rezili 255 mm
198426-9	Komplet plastičnih rezil za glavo 198383-1 (12/1)
191D89-4	Rezilna glava - najlonska nitka
B-14118	Rezilna plošča - 230 mm štirikraka
B-14130	Rezilna plošča - 230 mm, osemkraka

## EY403MP - verižna žaga

165245-8	Meč z verižnikom 300/1,1 mm, 3/8"
531291646	Veriga žage 300/1,1 mm, 3/8"
419288-5	Ščitnik za meč 300 mm

## EY401MP - verižna žaga

165695-7	Meč z verižnikom 250/1,3 mm, 3/8"
196142-7	Veriga žage 250/1,3 mm, 3/8"
418845-6	Ščitnik za meč 250 mm

## EN420MP - škarje za travo in živo mejo

458342-0	Ščitnik rezila za živo mejo
----------	-----------------------------

## SW400MP - nastavek za pometanje

XNR0000549	Rezervno kolo za pometanje
------------	----------------------------

## BR400MP - nastavek za krtačenje

XNR0000548	Rezervna krtača
------------	-----------------



## Rezila in zaščita rezil škarij za živo mejo

### A: ZAKRIVLJENO REZILO

Optimalna oblika rezil za gladko rezanje



Zelo ostri robovi rezil:  
Gornji del rezil je zakrivljen navzdol  
Spodnji del rezil je zakrivljen navzgor



Stična površina je le na vrhu rezila

Enostavno in čvrsto zagradi veje



Zagradi enostavno

Drži čvrsto in odreže



### B: VISOKO-KAKOVOSTNO REZILO

Zgornje in spodnje rezilo s tremi zelo ostrimi robovi za čisto rezanje



Rezilo s tremi zelo ostrimi robovi poskrbi za čist rez in minimalno poškodbo veje.



### C: REZILO BREZ MADEŽEV

Ne-elektrolizirana nikljeva prevleka

Enakomerno in močno nanešen površinski premaz z visoko odpornostjo proti obrabi za dolgo obstojnost površine.



Površina rezila

(po 10 urah obrezovanja okrasnega drevja)



Rezila brez madežev



Ostale vrste rezil

Za model	Celotna dolžina	Tip	Rezilo	Zaščita rezila
DUM168, UM164D, UH200D	200 mm	/	195243-8	452055-5
UH200D, DUM168, UM164	200 mm	/	195272-1	458342-0
DUM604, UH201D, UM600D, UM603	200 mm	C	198408-1	458342-0
UH4261	420 mm	C	140826-9	9101MA0201
UH4570	450 mm	C	194660-9	450489-6
DUN461W, UN460WD	460 mm	/	191P00-8	413720-1
UH4861	480 mm	C	140830-8	452685-2
DUH483	480 mm	C	195768-2	452685-2
DUN500	500 mm	A	191C14-9	458413-3
EH5000W	500 mm	B	196795-2	452328-6
DUH501	500 mm	A	199098-3	458413-3
DUH502	500 mm	B	199598-3	459120-1
UH5261	520 mm	C	140827-7	452685-2
DUH523	520 mm	C	195769-0	452685-2
UH5570	550 mm	C	194663-3	450489-6
DUH551	550 mm	C	196687-5	450489-6
DUN600	600 mm	A	191C13-1	458414-1
DUH604	600 mm	A	191D38-1	412769-8
UH004G	600 mm	A	191R53-9	412911-1
UH006G	600 mm	B	191R55-5	412911-1
UH008G	600 mm	B	191R57-1	459121-9
UH013G	600 mm	A	191Y03-6	413B98-4
EH6000W	600 mm	B	196797-8	452327-8
DUH601	600 mm	A	199099-1	458414-1
DUH602	600 mm	B	199599-1	459121-9
UH6570	650 mm	C	194666-7	450490-1
UH6580, DUH651	650 mm	C	194673-0	450490-1
DUH651	650 mm	C	196688-3	450490-1
DUH754	750 mm	A	191D39-9	412770-3
UH005G	750 mm	A	191R54-7	412912-9
UH007G	750 mm	B	191R56-3	412912-9
UH009G	750 mm	B	191R58-9	459122-7
UH014G	750 mm	A	191Y05-2	413B99-2
UH7580	750 mm	C	194675-6	450490-1
EH7500W	750 mm	B	196799-4	452326-0
DUH751	750 mm	A	199100-2	412912-9
DUH752	750 mm	B	199600-2	459122-7

Akumulat orji in polnilniki  
 Pribor za akumulat orsko orodje  
 Akumulat orske svetilke in pribor  
 Pribor za laserske merilnike  
 Pribor za rušenje in vrtanje  
 Pribor za vrtanje  
 Kronske žage  
 Pribor za vijachenje  
 Pribor za rezanje in brušenje  
 Pribor za poliranje in brušenje  
 Pribor za rezkanje in oblanje  
 Pribor za multifunk cliko orodje  
 Pribor za zaganje  
 Pribor za žebjalnike in spenjalnike  
 Pribor za fene  
 Pribor za sesanje  
 Pribor za posejle orodja za uporabo na prostem  
 Pribor za posejle orodja za zaščita oprema  
 Kovčki in torbe za orodje  
 Ročno orodje  
 Razno  
 Pribor za mešanje



## Škarje za živo mejo



## Zbiralni ščiti

Koda	Za model	Cena z DDV
191D33-1	DUH604	
191D34-9	DUH754	
191R51-3	UH004G, UH006G, UH008G	
191R52-1	UH005G, UH007G, UH009G	
191T43-4	DUN461W, UN460WD	
194681-1	DUH551, DUH651, UH4570, UH5570, UH5580, UH6580, UH6850, UH7580	
195050-9	DUH483, DUH523, UH4260, UH4261, UH4860, UH4861, UH5260, UH5261	
195279-7	UH200D, UM164, DUM168	
195321-4	EH6000W, EH7500S, EH7500W	
198401-5	DUM604, UH201, UM600D, UM603D, UM164, DUM111, UM110D	
199151-5	DUH501, DUH502, DUH601, DUH602, DUH751, DUH752	

## Držala za kabel

	Koda	Naziv	Za model	Cena z DDV
	158024-1	Držalo za kabel	UH4261, UH4570, UH4861, UH5570, UH5261, UH5580, UH6570, UH6580, UH7580	
	194677-2	Držalo za kabel - pas	UH4261, UH4570, UH4861, UH5570, UH5261, UH5580, UH6570, UH6580, UH7580	
	194679-8	Držalo za kabel - zapetnica	UH4261, UH4570, UH4861, UH5570, UH5261, UH5580, UH6570, UH6580, UH7580	







# Pribor orodja za uporabo na prostem

297

## Maziva

### Maziva

Koda	Naziv	Primerno za	Cena z DDV	
197439-7	Mast za multifunkcijsko glavo 80ml	Primerna za teleskopske škarje za živo mejo in večnamenske nastavke.		
199450-5	Mast 80 ml	Primerna za Makita rezalnike za živo mejo in kose.		

## Akumulatorske škarje za travo

### Pribor

Koda	Naziv	Za model	Cena z DDV	
191N23-4	Rezilo za travo 110mm	DUM111, DUM110, UM110D		
191N24-2	Rezilo za živo mejo 200mm	DUM111, DUM110, UM110D		
195187-2	Podaljšan ročaj za akumulatorske škarje za travo	DUM166, DUM168, UM164D, UM165D, UM167D, UH200D		
195267-4	Rezilo za travo 160 mm	DUM168, UM164, UH200, DUM604, DUM600		
198401-5	Zbiralni ščit za živo mejo	DUM604, UH201, UM600D, UM603D, UM164, DUM111, UM110D		
198486-1	Podaljšan ročaj na kolesih	DUM604, UM600D, UM603D, UH2011D, DUM111, UM110D		
452055-5	Zaščita rezila za travo	DUM168, UM164, UH200D, DUM604, UM600D		
452198-3	Zaščita rezila za travo	DUM111, UM110D		
454880-0	Zbiralni ščit za travo	DUM111, DUM110, UM110D		

[Nadaljevanje...](#)

Akumulat  
orji in  
pnilniki

Pribor za  
akumulat  
orsko  
orodje

Akumulat  
orske  
svetilke  
in pribor

Pribor za  
lasarske  
merilnike

Pribor za  
rušenje  
in vrtanje

Pribor za  
vrtanje

Kronske  
žage

Pribor za  
vijačenje

Pribor za  
rezanje  
in  
brušenje

Pribor za  
poliranje  
in  
brušenje

Pribor za  
rezkanje  
in  
oblanje

Pribor za  
multifunk  
cijsko  
orodje

Pribor za  
žaganje

Pribor za  
žebjalnike  
in  
spenjalnike

Pribor za  
fene

Pribor za  
sesanje

Pribor  
orodja za  
uporabo  
na prostem

Pribor za  
ploščje  
orodja in  
zaščitna  
oprema

Kovčki in  
torbe za  
orodje

Ročno  
orodje

Razno

Pribor za  
mešanje









# Pribor orodja za uporabo na prostem

	Koda	Naziv	Za model	Cena z DDV
	457426-1	Zbiralni ščit za travo 160 mm	DUM604, UM603D, UM600D, UM164, DUM168, UH200, DUM600, UH201	

## Akumulatorske škarje za obrezovanje



### Akumulatorske škarje za obrezovanje

	Koda	Naziv	Za model	Cena z DDV
	161377-9	Naramnice	DUP361, DUP362	
	161379-5	Tok za prenašanje	DUP361, DUP362	
	161603-6	Dvojni ramenski pas za akumulator za DUP361 - ozek	DUP361, DUP362	
	197366-8	Zgornje rezilo za škarje	DUP361, DUP362	
	197367-6	Spodnje rezilo za škarje	DUP361, DUP362	
	199168-8	Zgornje rezilo za rezanje debelejših vej	DUP361, DUP362	
	199169-6	Spodnje rezilo za rezanje debelejših vej	DUP361, DUP362	
	199171-9	Spodnje rezilo za rezanje tanjših vej	DUP361, DUP362	
	199314-3	Zgornje rezilo za rezanje tanjših vej	DUP361, DUP362	

Nadaljevanje...

# Pribor orodja za uporabo na prostem

Koda	Naziv	Za model	Cena z DDV	
661445-3	Povezovalni kabel	DUP361, DUP362		
794530-8	Diamantna pila	DUP361, DUP362		

Akumulat  
orji in  
pnilniki

Pribor za  
akumulat  
orsko  
orodje

Akumulat  
orske  
svetilke  
in pribor

Pribor za  
lasarske  
merilnike

Pribor za  
rušenje  
in vrtanje

Pribor za  
vrtanje

Kronske  
žage

Pribor za  
vijačenje

Pribor za  
rezanje  
in  
brušenje

Pribor za  
poliranje  
in  
brušenje

Pribor za  
rezkanje  
in  
oblanje

Pribor za  
multitfunk  
ciljsko  
orodje

Pribor za  
žaganje

Pribor za  
žebjalnike  
in  
spenjalnike

Pribor za  
fene

Pribor za  
sesanje

Pribor  
orodja za  
uporabo  
na prostem

Pribor za  
pomoč je  
orodja in  
zaščitna  
oprema









Kovčki in  
torbe za  
orodje

Ročno  
orodje

Razno

Pribor za  
mešanje

## REZILNE PLOŠČE IN GLAVE





TIP		ZA NIZKO MLADO TRAVO	ZA VISOKO STAREJŠO TRAVO	ZA GRMIČEVJE
<b>Rezilna glava</b> z najlonsko nitko		←→		
<b>Rezilna glava</b> s tremi plastičnimi rezili		←→		
<b>Rezilna plošča,</b> dvokraka		←→		
<b>Rezilna plošča,</b> štirikraka		←→		
<b>Rezilna plošča,</b> osemkraka		←→		
<b>Rezilna plošča,</b> trikraka		←→		
<b>Drobilna plošča,</b> dvokraka			←→	
<b>Rezilna plošča,</b> 80 zob				←→
<b>Rezilna plošča</b> v obliki dleta				←→

## HITRO-MENJALNE REZILNE GLAVE





**Enostavna namestitev najlonske nitke brez potrebe po razstavljanju rezalne glave**



čas namestitve najlonske nitke 0 → 85 s



Standardne rezilne glave					
	1. razstavi glavo	2. navij nitko na kolut	3. pritrdi kolut na glavo	4. sestavi glavo	5. zaključek





čas namestitve najlonske nitke 0 → 35 s

Hitro-menjalne rezilne glave				
	1. poravnaj trikotni oznaki	2. vstavi nitko	3. obrni gumb	4. zaključek







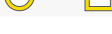



do **58%**  
hitrejša namestitev

# NAJLONSKE NITKE

OBLIKA	OSTRINA	ENERGIJSKA UČINKOVITOST	NIZKA GLASNOST
okrogla 		★	★
kvadratna 	★★		
štiri-delna 	★	★★	★★

TIP NITKE Diameter/Oblika	LAHKO DELO		ZAHTEVNO DELO	
	Nizka trava		Visoka trava	
	Nizka gostota	Visoka gostota	Nizka gostota	Visoka gostota
1,3 mm 	←→			
1,6-1,65 mm 	←→			
2,0 mm 		←→		
2,4 mm 		←→	←→	
2,7 mm 			←→	←→
3,0 mm 			←→	←→

## Standardne najlonske nitke

MODEL	Barva/oblika	Plasti	Diameter	Dolžina
E-02727		Enojna	1,3 mm	15 m
E-02733		Enojna	1,6 mm	15 m
E-02705		Enojna	2 mm	15 m
E-02711		Enojna	2 mm	126 m
E-02749		Enojna	2,4 mm	15 m
E-02761		Enojna	2,4 mm	87 m
E-02783		Enojna	2,4 mm	262 m
E-02808		Enojna	2,4 mm	15 m
E-02814		Enojna	2,4 mm	69 m
E-02820		Enojna	2,4 mm	206 m

## Štiridelne najlonske nitke

Nizka stopnja hrupa in boljši izkoristek energije



### Štiridelna oblika

Posebna štiridelna oblika pri vrtenju ustvarja vrtnec, ki zmanjša zračni upor, za nižjo stopnjo hrupa in boljši izkoristek energije. Idealna za akumulatorske kose.

### Okrogla - zračni tok

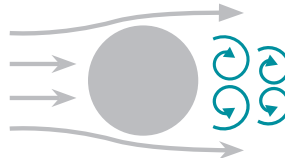

### Štiridelna - zračni tok



### Količina dela z enim polnjenjem aku.



### Primerjava hrupa

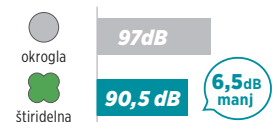







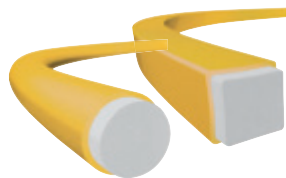







## Dvo-plastne najlonske nitke

Izboljšana vzdržljivost do 130%\* zahvaljujoč fleksibilnemu jedru ter zunanji plasti odporni na udarce in odrgnine.

\*v primerjavi s standarnimi najlonskimi nitkami



MODEL	Barva/oblika	Plasti	Diameter	Dolžina
E-02836		Dvojna	3,0 mm	15 m
E-02842		Dvojna	3,0 mm	56 m
E-02858		Dvojna	3,0 mm	168 m
E-02870		Dvojna	3,0 mm	15 m
E-02886		Dvojna	3,0 mm	44 m
E-02892		Dvojna	3,0 mm	132 m

MODEL	Barva/oblika	Plasti	Diameter	Dolžina
E-01731		Enojna	1,65 mm	15 m
E-01747		Enojna	1,65 mm	30 m
E-01753		Enojna	1,65 mm	445 m
E-01769		Enojna	2 mm	15 m
E-01775		Enojna	2 mm	30 m
E-01781		Enojna	2 mm	310 m
E-01797		Enojna	2,4 mm	15 m
E-01806		Enojna	2,4 mm	30 m
E-01812		Enojna	2,4 mm	225 m
E-01828		Enojna	2,7 mm	15 m
E-01834		Enojna	2,7 mm	30 m
E-01840		Enojna	2,7 mm	180 m



## Kose

## Rezilne glave z najlonsko nitko

	Koda	Naziv	Navoj vretena	Premer (Ø) (mm)	Za model	Cena z DDV
	122882-1	Rezilna glava, polavtomatska, 2 najlonski nitki	M10X1,25	2,4	UH4350UH	
	122931-4	Rezilna glava, polavtomatska, 2 najlonski nitki	M10X1,25 LH	2,4	EBH341R, EBH341L, EBH341U, EBH252, EBH253, EM2651L, EM2651U, RBC413, RBC414	
	122977-0	Rezilna glava z najlonsko nitko	M8 x 1.25	2,4	DBC260L	
	123235-7	Rezilna glava z dvema najlonskima nitkama	M8X1,25LH	2	DUR182L, DUR187, DUR188	
	191D89-4	Hitro menjalna rezilna glava	M10x1.25LH	2	UR101C, DUR190L, DUR190U, DUR191L, DUR191U, DUR194, UR201C, UR202C, UR002G, DUR365, DUR366, DUR368L, DUR369A, DUR369L, DUR369N	
	191D90-9	Hitro menjalna rezilna glava	M10x1.25LH	2,4	EBH252L, EBH252U, EBH253L, EBH253U, EM2510L, EM2511L, EM3650U, EM2651L, EM2651U, EM2653L, EM2654L, EM400MP, EM401MP, EM403MP, EM404MP, EM405MP, EM406P, UR101C, UR201C, UR202C, DUR369A, DUR369L, DUR369N	
	191D92-5	Hitro menjalna rezilna glava	M8x1,25 RH	2	DUR189	
	191Y39-5	Rezilna glava za najlonsko nitko DUR193	/	1,65	DUR193	
	195149-0	Rezilna glava, polavtomatska, 2 najlonski nitki	M10x1,25 LH	2,4	BBC231U, EBH252U, EBH253U, EM2651UH, BUX361, DUR365U, DUR366L	
	196146-9	Rezilna glava z najlonsko nitko	/	2	DUR141, DUR181, UR140D, UR180D	
	196324-1	Hitro menjalna rezilna glava	M10x1.25L	2,4	EM2654LH, UR002G	
	197030-1	Rezilna glava z najlonsko nitko	M10x1.25LH	3,0	EBH341U/L/R, EM4350UH/LH/RH, EM4351UH, RBC411U, RBC412U, RBC413U, RBC414U	

[Nadaljevanje...](#)

# Pribor orodja za uporabo na prostem

Koda	Naziv	Navoj vretena	Premer (Ø) (mm)	Za model	Cena z DDV	
197993-1	Rezilna glava	M10x1,25LH	2,4	UR006G, UR007G, UR012G, DUR369, UR101, UR201		
198266-5	Hitro menjalna rezilna glava	M10x1,25LH	2,4	UR007, UR006, DUR369, UR101, UR201		
198385-7	Rezilna glava	M8X1,25LH	2	DUR187L/U, DUR188L/U, DUR182		
198854-8	Rezilna glava	M8x1,25RH	1,65	UR100D		
198893-8	Rezilna glava	95-M10L	2	DUR190, DUR191, DUR192L, DUDUR365U, DUR366L, DUR368A/L, DUR369A/L, EBH252U/L, EBH253U/L, EM2510LH, EM2511LH, EM2650UH/LH, EM2651UH/LH, EM2653LH, EM2654LH, UR101C, UR201C, UR202C, UR002G, UR003G, UR006G, UR007G, EM400MP, EM401MP, EM403MP, EM404MP, EM405MP		
198971-4	Rezilna glava z najlonsko nitko	M8x1,25RH	2	DUR189		
384224503	Rezilna glava z dvema najlonskima nitkama, avtomatska	M10x1,25 LH	3	DBC4010, DBC4510		
957385030	Rezilna glava z dvema najlonskima nitkama	M12X1,5LH	2	DBC4010, DBC4510		
B-01959	Rezilna glava z dvema najlonskima nitkama	M8	2	RBC261		
B-02945	Rezilna glava z dvema najlonskima nitkama z adapterjem, avtomatska Ultra Auto 4L	M8&M10x1,25 LH	2,4	Univerzalna leva		
B-03006	Rezilna glava z dvema najlonskima nitkama, avtomatska Ultra Auto 4R	M8&M10X 1,25 RH	2	Univerzalna desna		
DA00000454	Rezilna glava z najlonsko nitko	M8X1,25LH	2,5	EM2600L, EM2600U		
YA00000649	Rezilna glava	M8X1,25	2	UR3500, UR3501		







Nadaljevanje...

- Akumulat orji in polnilniki
- Pribor za akumulat orsko orodje
- Akumulat orske svetilke in pribor
- Pribor za laserske merilnike
- Pribor za rušenje in vrtanje
- Pribor za vrtanje
- Kronске žage
- Pribor za vijačenje
- Pribor za rezanje in brušenje
- Pribor za poliranje in brušenje
- Pribor za rezkanje in oblanje
- Pribor za multifunkcijsko orodje
- Pribor za žaganje
- Pribor za žebjalnike in spenjalnike
- Pribor za fene
- Pribor za sesanje
- Pribor za uporabo na prostem
- Pribor za ročno orodje in zaščitna oprema
- Kovčki in torbe za orodje
- Ročno orodje
- Razno
- Pribor za mešanje





# Pribor orodja za uporabo na prostem

	Koda	Naziv	Navoj vretena	Premer (Ø) (mm)	Za model	Cena z DDV
	YA00000651	Rezilna glava z nitko	M8X1,25	1,65	UR3500, UR3501	

## Rezilne glave s plastičnimi rezili



	Koda	Naziv	Navoj vretena	Za model	Enota (kos/set)	Cena z DDV
	198383-1	Rezilna glava s tremi plastičnimi rezili	M8 & M10 x 1,25 LH, M8 x 1,25 RH	DUR190, DUR191, DUR194, DUR187L/U, DUR188L/U, DUR189, DUR364L, DUR365U, DUR366L, DUR368A/L, DUR369A/L/N, UR101C, UR201C, UR002G, UR003G, UR012G, EM403MP, EM404MP, EM405MP, EM406MP	1	
	198426-9	Komplet plastičnih rezil		198383-1	12/1	
	198848-3	Rezilna glava s plastičnim rezilom	M8 x 1,25 RH	UR100D	1	
	198851-4	Komplet plastičnih rezil		198848-3	5/1	
	199868-0	Rezilna glava s tremi plastičnimi rezili	M10 x 1,25 LH	UR012G	1	
	199870-3	Komplet plastičnih rezil		199868-0	12/1	

## Rezilne plošče

	Koda	Naziv	Premer (Ø) (mm)	Premer luknje (Ø) (mm)	Število zob	Za model	Cena z DDV
	191M75-9	Reznik podrastja EM407MP (za kose)	230	/	/	DUR369, UR101C, UR201C, UR006G, UR007G, EM2511LH, EM2651UH, EM2654LH	
	191W97-9	Komplet pribora za rezilno ploščo	/	25,4	/	DUR190L, DUR190U, DUR191L, DUR191U	
	195624-6	Rezilna plošča na dva kraka	305	25,4	2	RBC414U	
	198345-9	Rezilna plošča, dvokraka	255	25,4	2	DUR369, UR101C, UR201C, UR006G, UR007G	

[Nadaljevanje...](#)

# Pribor orodja za uporabo na prostem

Koda	Naziv	Premer (Ø) (mm)	Premer luknje (Ø) (mm)	Število zob	Za model	Cena z DDV	
199874-5	Droblilna plošča, dvokraka	270	25,4	2	UR012G		
D-66058	Rezilna plošča, dvokraka	230	25,4	2	DUR361U, DUR362U, EBH252U, EBH253U, EM2500U/L, EM2510LH, EM2511LH, EM2600U/L, EM2650LH/UH, EM2651LH/UH, EM2653LH, EM2654LH, EM400MP, EM401MP, EM402MP, EM403MP, EM404MP		
D-66064	Rezilna plošča, dvokraka	255	25,4	2	EBH340U/R, EBH341L/U/R, EM3400U/L, EM4350UH/LH/RH, EM4351UH, RBC411U, RBC412U, RBC413U, RBC414U, DUR369A/L, UR101C, UR201C		
195298-3	Rezilna plošča, trikraka	230	25,4	3	EM2600U/L, EM2650UH, EM2651UH, UR002G, UR006G, UR007G		
195299-1	Rezilna plošča, trikraka	255	25,4	3	EBH341U, RBC411U, RBC412U, EM4351UH, EM4350UH/RH, EM3400U, UR006G, UR007G		
385224350	Rezilna plošča, trikraka	225	20	3	DBC340		
D-66020	Rezilna plošča, trikraka	230	25,4	3	EBH341U, RBC411U, RBC412U, EM4351UH, EM4350UH/RH, EM3400U		
D-66036	Rezilna plošča, trikraka	257	25,4	3	EBH340U/R, EBH341L/U/R, EM3400U/L, EM4350UH/LH/RH, EM4351UH, RBC411U, RBC412U, RBC413U, RBC414U		
D-66042	Rezilna plošča, trikraka	305	25,4	3	EBH341L/U, EM4350LH/UH, EM4351UH, RBC411U, RBC412U, RBC413U, RBC414U		
372224140	Rezilna plošča, štirikraka	200	20	4	DBC310		
385224140	Rezilna plošča, štirikraka	255	20	4	DBC4010, DBC4510		
B-14118	Rezilna plošča, štirikraka	230	25,4	4	BBC231U, BUX361, DUR182, EBH341L/R/U, EBH252L/U, EBH253L/U, EM2600U, EM2651L/U, RBC2500, RBC3101, RBC420E, DUR361U, DUR365, DUR364, DUR366L, DUR368A/L		

Nadaljevanje...

- Akumulat orji in polnilniki
- Pribor za akumulat orsko orodje
- Akumulat orske svetilke in pribor
- Pribor za lasarske merilnike
- Pribor za rušenje in vrtanje
- Pribor za vrtanje
- Kronske žage
- Pribor za vijachenje
- Pribor za rezanje in brušenje
- Pribor za poliranje in brušenje
- Pribor za rezkanje in oblanje
- Pribor za multitfunkcijsko orodje
- Pribor za žaganje
- Pribor za žebjalnike in spenjalnike
- Pribor za fene
- Pribor za sesanje
- Pribor orodja za uporabo na prostem
- Pribor za ploščne orodje in zaščitna oprema
- Kovčki in torbe za orodje
- Ročno orodje
- Razno
- Pribor za mešanje

# Pribor orodja za uporabo na prostem

	Koda	Naziv	Premer (Ø) (mm)	Premer luknje (Ø) (mm)	Število zob	Za model	Cena z DDV
Akumulat orji in polnilniki							
Pribor za akumulat orsko orodje	B-14124	Rezilna plošča, štirikraka	255	25,4	4	EBH341U/L/R, RBC420E	
Akumulat orske svetilke in pribor							
Pribor za lasarske merilnike	D-66008	Rezilna plošča, štirikraka	230	25,4	4	BBC231U, BUX361, DUR182, EBH341L/R/U, EBH252L/U, EBH253L/U, EM2600U, EM2651L/U, RBC2500, RBC3101, RBC420E, DUR361U, DUR365, DUR364, DUR366L, UR003G	
Pribor za rušenje in vrtanje							
Pribor za vrtanje	D-66014	Rezilna plošča, štirikraka	255	25,4	4	ER2550LH	
Kronске žage							
Pribor za vijačenje	191Y44-2	Rezilna plošča, osemkraka	200	25,4	8	DUR194	
Pribor za rezanje in brušenje							
Pribor za rezanje in brušenje	380224180	Rezilna plošča, osemkraka	200	20	8	DBC300, DBC310	
Pribor za poliranje in brušenje							
Pribor za poliranje in brušenje	385224180	Rezilna plošča, osemkraka	250	20	8	DBC4010D, DBC4510D	
Pribor za rezkanje in oblanje							
Pribor za rezkanje in oblanje	6418501900	Rezilna plošča, osemkraka	255	25,4	8	EBH341R, EM4350UH/RH, EM4351UH, EM3400U	
Pribor za multitank orodje							
Pribor za multitank orodje	B-14130	Rezilna plošča, osemkraka	230	25,4	8	DUR182, DUR366L, EBH341U/L/R, EBH252L/U, EBH253L/U, EM2600U, EM2651L/U, RBC2100, RBC2110, RBC2500, RBC3101, RBC420E	
Pribor za žebjalnike in spenjalnike							
Pribor za žebjalnike in spenjalnike	199872-9	Rezilna plošča z zobmi v obliki dleta	225	25,4	24	UR012G	
Pribor za fene							
Pribor za sesanje	385224161	Rezilna plošča z zobmi v obliki dleta	255	20	24	DBC4010, DBC4510	
Pribor za rosanje orodja za uporabo na prostem							
Pribor za rosanje orodja za uporabo na prostem	B-14152	Rezilna plošča, 80 - zob	230	25,4	80	EBH252L/U, EBH253L/U, EBH341U/L/R, EBH341L/R, EM2651L/U, RBC2500, RBC3101, RBC420E	
Pribor za rosanje orodja za uporabo na prostem							
Kovčki in torbe za orodje							
Ročno orodje							
Razno							
Pribor za mešanje							



# Pribor orodja za uporabo na prostem

307

## Ščitniki rezil in najlonskih glav

Koda	Naziv	Za model	Gena z DDV	
010341612	Ščitnik rezila	DBC4010D, DBC4510D		
135398-7	Spodnji ščitnik za nitko	EBH250U, EBH252U, EBH253U, EBH341U, EM2650UH, EM2651UH		
135753-3	Spodnji ščitnik za nitko	EBH252, EBH253, EBH341, EM2651, EM2654, EM4350, EM4351		
135950-1	Ščitnik UR100D	UR100D		
140424-9	Spodnji ščitnik za nitko	EM3400U/L, EM4350, EM4351		
140583-9	Spodnji ščitnik za nitko	BBC231U, BC231UD		
140X35-4	Podaljšek ščitnika EM408MP	EM408MP		
141015-9	Spodnji ščitnik za nitko	ER2550LH		
144316-4	Spodnji ščitnik za nitko	UR101C, UR201C, DUR369A, DUR369L		
191B54-1	Ščitnik rezila	DUR369A, DUR369L, UR101C, UR201C, UR003G		
196577-2	Ščitnik rezila	DUR182L		
197294-7	Ščitnik rezila za kose	DUR368A, DUR368L		
197295-5	Ščitnik za nitko	DUR365U, DUR368A/L, UR003G		

[Nadaljevanje...](#)

Akumulat  
orji in  
povlečni

Pribor za  
akumulat  
orsko  
orodje

Akumulat  
orske  
svetilke  
in pribor

Pribor za  
laserske  
merilnike

Pribor za  
rušenje  
in vrtanje

Pribor za  
vrtanje

Kronske  
žage

Pribor za  
vijačenje

Pribor za  
rezanje  
in  
brušenje

Pribor za  
poliranje  
in  
brušenje

Pribor za  
rezkanje  
in  
oblanje

Pribor za  
multitank  
ciljsko  
orodje

Pribor za  
žaganje

Pribor za  
žebjalnike  
in  
spenjalnike

Pribor za  
fene

Pribor za  
sesanje

Pribor  
orodja za  
uporabo  
na prostem

Pribor za  
nogoje  
orodja in  
zaščitna  
oprema

Kovčki in  
torbe za  
orodje

Ročno  
orodje

Razno

Pribor za  
mešanje

# Pribor orodja za uporabo na prostem

	Koda	Naziv	Za model	Cena z DDV
Akumulat orji in polnilniki				
Pribor za akumulat orsko orodje	197806-6	Ščitnik za najlonsko nitko	EM2511LH	
Akumulat orske svetilke in pribor	199873-7	Ščitnik za rezilno ploščo	UR012G	
Pribor za lasarske mešalnike	199875-3	Ščitnik za drobilno ploščo	UR012G	
Pribor za rušenje in vrtanje	412392-9	Ščitnik za nitko	DUR190L, DUR190U, DUR191L, DUR191U	
Pribor za vrtanje	412580-8	Ščitnik rezila	DUR192L	
Kronske žage	412969-0	Ščitnik za EM408MP	EM408MP	
Pribor za vijačenje	413F73-4	Ščitnik DUR193	DUR193	
Pribor za rezanje in brušenje	450573-7	Zaščita rezila	EBH252U	
Pribor za poliranje in brušenje	451252-0	Ščitnik rezila	EBH341U, EM2650UH, EM2651UH	
Pribor za rezkanje in oblanje	451566-7	Ščitnik rezila	BBC231U, BC231UD	
Pribor za multitank cijsko orodje	451878-8	Ščitnik za nož	EM3400U/L	
Pribor za žaganje	452259-9	Ščitnik rezila	EBH341U, EM4350UH, EM4351UH, RBC413U	
Pribor za žebjalnike in spenjalnike	452260-4	Ščitnik rezila	EBH252U, EBH253U, EM2650UH, EM2651UH, EM2654LH, EM2511LH	
Pribor za fene	453353-0	Ščitnik za nitko	DUR181	
Pribor za sesanje				
Pribor za uporabo na prostem				
Pribor za nosenje orodja in zaščitna oprema				
Kovčki in torbe za orodje				
Ročno orodje				
Razno				
Pribor za mešanje				

[Nadaljevanje...](#)

# Pribor orodja za uporabo na prostem

Koda	Naziv	Za model	Cena z DDV	
454640-0	Ščitnik za nitko	DUR182L		
455172-0	Ščitnik rezila	DUR361U		
455622-5	Ščitnik za nitko	DUR364L		
455815-4	Ščitnik rezila	DUR365U, DUR368A/L		
455926-5	Ščitnik za nitko	DUR365, DUR366		
456651-1	Ščitnik za nitko	DUR184L		
457271-4	Ščitnik rezila	UR101C, UR201C, DUR369A, DUR369L		
457324-9	Ščitnik za nitko	DUR187, DUR188		
6258061002	Ščitnik rezila	RBC2100		
6258064001	Ščitnik rezila	DBC260U		
6278011002	Ščitnik rezila	RBC3101		
6358008004	Ščitnik rezila	RBC420E		
6418027000	Ščitnik rezila	DBC260U, EBH341R, RBC250, RBC2500, RBC420E, EM4250		
DA00000525	Ščitnik za nož	EM2500U/L, EM2600U/L		











[Nadaljevanje...](#)

- Akumulat orji in polnilniki
- Pribor za akumulat orodje
- Akumulat orske svetilke in pribor
- Pribor za lasarske merilnike
- Pribor za rušenje in vrtanje
- Pribor za vrtanje
- Kronske žage
- Pribor za vijačenje
- Pribor za rezanje in brušenje
- Pribor za poliranje in brušenje
- Pribor za rezkanje in oblanje
- Pribor za multitank orodje
- Pribor za rezkanje in žaganje
- Pribor za žebjalnike in spenjalnike
- Pribor za fene
- Pribor za sesanje
- Pribor orodja za uporabo na prostem
- Pribor za ploščice orodja in zaščitna oprema
- Kovčki in torbe za orodje
- Ročno orodje
- Razno
- Pribor za mešanje

# Pribor orodja za uporabo na prostem

	Koda	Naziv	Za model	Cena z DDV
	DA00000526	Spodnji ščitnik za nitko	EM2500U	
	XNR0000501	Zaščita rezila	EBH341R	

## Naramni in navadni pasovi

	Koda	Naziv	Za model	Cena z DDV
	122906-3	Ramenski pas	DUR369A, EBH252U, EBH253U, EBH341U, EM2650UH, EM2651UH, EM4350UH, RBC411U, RBC412U, RBC413U, RBC414U, UR002G, UR006G, UR007G	
	122907-1	Pas	BBC, BC, EBH, EM	
	122A37-4	Ramenski pas	UR006G, UR007G, UR012G	
	125516-5	Ramenski pas	DUN500W, DUN501W, DUR181, DUR184L, DUR187L, DUR188L, DUR189, DUR190L, DUR191L, DUR192L, DUR194, DUR364L, DUR368A, DUR368L, UR100D, UR180D, DUR366L, DUX60	
	125520-4	Ramenski pas za kose	DUR191, DUR191, DUR187U, DUR188U, DUR368A/L, DUR369L, RBC413U, RBC414U	
	126012-6	Ramenski pas	RBC2500, RBC2510, RBC3110	
	127508-0	Ramenski pas	DUX18, DUR192L, DUR193, DUR194, UR002G, UR003G, UX01G	
	191K37-5	Ramenski pas	DUA301	
	197243-4	Ramenski pas	UR101C, UR201C	
	6417015004	Pas	RBC420E	



[Nadaljevanje...](#)

# Pribor orodja za uporabo na prostem

311

Koda	Naziv	Za model	Cena z DDV	
DA00000037	Ramenski pas	UR3000		
XNR0000474	Ramenski pas EBH/ BC/ BBC	BBC, BC, EBH, EM		

## Kavlji

Koda	Naziv	Za model	Cena z DDV	
140400-3	Kavelj	EBH252U		
168578-0	Kavelj	EBH341U, EBH252U		

## Kosilnice

## Noži



Koda	Celotna dolžina (mm)	Za model	Cena z DDV
671002550	330	ELM3311, ELM3310	
GB00000042	330	DLM330	
YA00000745	330	ELM3320	
671002549	370	ELM3711	
YA00000746	370	ELM3720	
191D41-2	380	DLM382	
671001427	410	ELM4110	
671001433	410	PLM4120N	
YA00000738	410	ELM4121	
YA00000747	410	ELM4120	
191D43-8	430	DLM432	
197760-4	430	DLM431, DLM432	
191D51-9	460	DLM462, DLM465	
191Y63-8	460	DLM462	
199367-2	460	DLM462, DLM460	
671014610	460	PLM4610, PLM4611, PLM4618, PLM4621, PLM4622, PLM4627, PLM4630, PLM4631, PLM4632	

[Nadaljevanje...](#)

Akumulat  
orji in  
polnilniki

Pribor za  
akumulat  
orsko  
orodje

Akumulat  
orske  
svetilke  
in pribor

Pribor za  
laserske  
merilnike

Pribor za  
rušenje  
in vrtanje

Pribor za  
vrtanje

Kronske  
žage

Pribor za  
vijačenje

Pribor za  
rezanje  
in  
brušenje

Pribor za  
poliranje  
in  
brušenje

Pribor za  
rezkanje  
in  
oblanje

Pribor za  
multifunk  
ciljsko  
orodje

Pribor za  
žaganje

Pribor za  
žebjalnike  
in  
spenjalnike

Pribor za  
fene

Pribor za  
sesanje

Pribor  
orodja za  
uporabo  
na prostem

Pribor za  
ročje  
in  
zaščitna  
oprema

Kovčki in  
torbe za  
orodje

Ročno  
orodje

Razno  
orodje

Pribor za  
mešanje



# Pribor orodja za uporabo na prostem

Koda	Celotna dolžina (mm)	Za model	Cena z DDV
671146102	460	ELM4610, ELM4611, ELM4612, ELM4613	
YA00000741	460	ELM4620, ELM4621	
191V97-3	480	DLM480, DLM481, LM001J	
191Y64-6	480	DLM480, DLM481, LM001J	
671003181	480	PLM4817, PLM4818, PLM4819	
671002552	510	PLM5113, PLM5130, PLM5102	
DA00000944	510	PLM5120, PLM5121	
191V96-5	530	DLM538, DLM539, LM002J	
191W87-2	530	DLM533, DLM532, DLM530, LM001C	
191Y65-4	530	DLM538, DLM539, LM002J	
671002532	560	PLM5600N	



## Disk plošča z rezili

Noži so zasnovani tako, da ob stiku s trdimi predmeti zanihajo, kar zmanjša nevarnost poškodb vretena. Višje število rezil kosi travo na manjše delce, kar zmanjšuje možnosti zamašitve.

Koda	Naziv	Celotna dolžina (mm)	Za model	Cena z DDV
191D47-0	Noži za 191D49-6	/	191D49-6	
191D48-8	Noži za 191D50-1	/	191D50-1	
191D49-6	Disk plošča z noži DLM46x	460	DLM462, DLM465	
191D50-1	Disk plošča z noži DLM53x	530	DLM530, DLM532, DLM533, LM001C	



## Pokrov za mulčenje

Koda	Za model	Cena z DDV
127515-3	DLM462	

[Nadaljevanje...](#)

# Pribor orodja za uporabo na prostem

313

Koda	Za model	Cena z DDV
127516-1	DLM532, DLM530, LM001C	
127550-1	DLM533	
412273-7	DLM432, DLM382	
413945-7	DLM538, DLM539, LM002J	
413946-5	DLM480, DLM481, LM001J	
671315001	PLM5600N	
671326001	PLM4618, PLM4628N, PLM4627N	
671469001	ELM4611, ELM4610, PLM5102, PLM4612, PLM4611PLM4610, PLM4110	
671509001	PLM5113, PLM5130	
671660001	DLM460	
671936001	PLM4632N, PLM4631N, PLM4630N, ELM4612, ELM4613, PLM5130N	
GB00000067	DLM330	

## Prezračevalniki

### Valji in noži

Koda	Naziv	Za model	Cena z DDV	
652024718	Valj za prezračevanje	UV3200		
652024719	Valj za ventilacijo	UV3200		
652024746	Valj za prezračevanje	UV3600		
652024749	Kombinirani valj	UV3600		
652024750	Valj za ventilacijo	UV3600		

Akumulat  
orji in  
povliniki

Pribor za  
akumulat  
orsko  
orodje

Akumulat  
orske  
svetilke  
in pribor

Pribor za  
laserske  
merilnike

Pribor za  
rušenje  
in vrtanje

Pribor za  
vrtanje

Kronske  
žage

Pribor za  
vijačenje

Pribor za  
rezanje  
in  
brušenje

Pribor za  
poliranje  
in  
brušenje

Pribor za  
rezkanje  
in  
oblanje

Pribor za  
multifunk  
ciljsko  
orodje

Pribor za  
žaganje

Pribor za  
žebjalnike  
in  
spenjalnike

Pribor za  
fene

Pribor za  
sesanje

Pribor  
orodja za  
uporabo  
na prostem

Pribor za  
prijem  
orodja in  
zaščitna  
oprema

Kovčki in  
torbe za  
orodje

Ročno  
orodje

Razno

Pribor za  
mešanje

## Puhalniki















## Pribor za puhalnike

	Koda	Naziv	Za model	Cena z DDV
	122321-1	Vrečka za prah	UB1103	
	123241-2	Vrečka za prah	DUB182, DUB183, UB1102, UB1103, UB100D, UB101D	
	123245-4	Šoba	DUB185, UB1103, UB100D, UB101D	
	123246-2	Dolga šoba 430 mm	UB1103, UB100D, UB101D	
	132025-7	Šoba 220 mm	BVC340, BVC350, DUB182, DVC340, DVC350, UB1101, UB120D, UB181D	
	134182-7	Šoba 430 mm	DVC340, DVC350, UB1103	
	166094-6	Ramenski pas	DUB362, DVC350, BVC340, BVC350, DUB184, DGP180, UB001G	
	166095-4	Naramni pas	DUB183, DUB361, DUB362, UB360	
	168746-5	Vrtljiva cev	BBX7600	
	191750-9	Gibljiva cev 0,95	DUB182, DUB183	
	191B03-8	Šoba za čiščenje žlebov	DUB184, DUB362, DUB363, UB001C, UB001G	
	191B21-6	Adapter 80-72	DUB184	
	191C15-7	Adapter B	UB400MP, UB401MP	
	191E19-1	5-delni set za sesanje	DUB363	
	191G09-6	Ukrivljena dolga šoba	DUB142, DUB143, DUB182, DUB183, DUB185, DUB186, UB1102, UB1103, UB100D, UB101D	
	191J13-3	Adapter 71	DUB362	

[Nadaljevanje...](#)

# Pribor orodja za uporabo na prostem

315

Koda	Naziv	Za model	Cena z DDV	
191J48-4	Ramenski pas	UB001C, UB001G		
191L13-5	Adapter 80-72	DUB184		
191L96-5	Adapter 85-72	UB001C, UB001G		
191M30-1	Krtača za prah	DUB142, DUB143, DUB182, DUB183, DUB185, DUB186, UB1102, UB1103, UB100D, UB101D		
191M32-7	Nastavek za razpihovanje	DUB142, DUB143, DUB182, DUB183, DUB185, DUB186, UB1102, UB1103, UB100D, UB101D		
191M34-3	Gibljiva cev za puhalnike	DUB142, DUB143, DUB182, DUB183, DUB185, DUB186, UB1102, UB1103, UB100D, UB101D		
191P97-7	Šoba 80	UB001C, UB001G		
196334-8	Antistatični trak	BBX7600		
196643-5	Gibljiva cev 0,95	UB1102, UB1103, UB100D, UB101D		
196729-5	Ukrivljena šoba	UB1103		
196956-4	Pas	EB5300TH, EB7650TH, EB7660TH		
197235-3	2-delni set za sesanje	BHX2501		
197888-8	Okrogla šoba	DUB362, DUB363, UB001C, UB001G		
197889-6	Ploščata šoba	DUB362, DUB363, UB001C, UB001G		
451752-0	Cev	PM7651H, BX2501		

Nadaljevanje...

Akumulat  
orj in  
polnilniki

Pribor za  
akumulat  
orsko  
orodje

Akumulat  
orske  
svetilke  
in pribor

Pribor za  
lasarske  
merilnike

Pribor za  
rušenje  
in vrtanje

Pribor za  
vrtanje

Kronske  
žage

Pribor za  
vijačenje

Pribor za  
rezanje  
in  
brušenje

Pribor za  
poliranje  
in  
brušenje

Pribor za  
rezkanje  
in  
oblanje

Pribor za  
multifunk  
ciljsko  
orodje

Pribor za  
žaganje

Pribor za  
žebjalnike  
in  
spenjalnike

Pribor za  
fene

Pribor za  
sesanje

Pribor  
orodja za  
uporabo  
na prostem

Pribor za  
ploščate  
orodja in  
zaščitna  
oprema

Kovčki in  
torbe za  
orodje

Ročno  
orodje

Razno

Pribor za  
mešanje

# Pribor orodja za uporabo na prostem

	Koda	Naziv	Za model	Cena z DDV
Akumulat orji in polnilniki				
Pribor za akumulat orjsko orodje	452123-4	Šoba	DUB183, DUB361, UB360	
Akumulat orske svetilke in pribor	454895-7	Cev, 90 cm	EB5300TH, EB7650TH, EB7660TH	
Pribor za lasarske mehanike	454896-5	Okrogel konec cevi, 90-60	EB5300TH, EB7650TH, EB7660TH	
Pribor za rušenje in vrtanje	454916-5	Ploščata šoba, 90 cm	EB5300TH, EB7650TH, EB7660TH	
Pribor za vrtanje	455128-3	Okrogel konec cevi, 90-70	EB5300TH, EB7650TH, EB7660TH	
Kronske žage	455631-4	Podaljšek cevi za puhalnik, 20 cm	PM7651H	
Pribor za vijačenje	455632-2	Podaljšek cevi za puhalnik, 45 cm	PM7651H	
Pribor za rezanje in brušenje	455634-8	Ploščata šoba za puhalnik	PM7651H	
Pribor za poliranje in brušenje	455915-0	Dolga cev	DUB362	
Pribor za rezkanje in oblanje	456957-7	Podaljšek cevi za puhalnik	DUB184, DUB362	
Pribor za multitank cijsko orodje	456958-5	Ploščata šoba za puhalnik	DUB184, DUB362	
Pribor za žabljavke in spenjalnike	6609512200	Končna cev	BHX2501	
Pribor za fene	6679500000	Gibljava cev	BBX7600	
Pribor za sesanje	6679501801	Ravna cev	BBX7600	
Pribor za nosenje orodja za uporabo na prostem	GT00000002	2-delni set za sesanje	UB0801V	
Pribor za ročno orodje	GT34103808	Ploščata šoba	UB0800	
Razno				
Pribor za mešanje				



## Visokotlačne čistilne naprave



### Razpršilne pištole

Koda	Za model	Cena z DDV
40797	HW101	
3320152	HW102, HW111, HW112	
40718	HW110, HW130	
41323	HW120	
197842-2	HW1200, HW1300, DHW080	
40728	HW131	
3640920	HW132	



### Visokotlačne cevi in podaljški











Koda	Naziv	Dolžina cevi (m)	Za model	Cena z DDV
126766-5	Visokotlačna cev 5m	5	DHW080	
3640630	Visokotlačna cev	5	HW102	
41179	Podaljšek visokotlačne cevi	5	HW102	
40807	Visokotlačna cev	5,5	HW110	
3640660	Visokotlačna cev	5,5	HW111, HW112	
41181	Podaljšek visokotlačne cevi	8	HW111, HW112, HW132	







[Nadaljevanje...](#)

- Akumulat orji in pomliniki
- Pribor za akumulat orsko orodje
- Akumulat orske svetilke in pribor
- Pribor za laserske merilnike
- Pribor za rušenje in vrtanje
- Pribor za vrtanje
- Kronske žage
- Pribor za vijačenje
- Pribor za rezanje in brušenje
- Pribor za poliranje in brušenje
- Pribor za rezkanje in oblanje
- Pribor za multitfunkcijsko orodje
- Pribor za žaganje
- Pribor za žebjalnike in spenjalnike
- Pribor za fene
- Pribor za sesanje
- Pribor orodja za uporabo na prostem**
- Pribor za hladno orodje in zaščitna oprema
- Kovčki in torbe za orodje
- Ročno orodje
- Razno orodje
- Pribor za mešanje

# Pribor orodja za uporabo na prostem

	Koda	Naziv	Dolžina cevi (m)	Za model	Cena z DDV
	3163270	Visokotlačna cev	8	HW120	
	40106	Podaljšek visokotlačne cevi	15	HW120	
	123784-4	Visokotlačna cev	10	HW1200, DHW080	
	197845-6	Podaljšek visokotlačne cevi	5	HW1200, HW1300, DHW080	
	197847-2	Podaljšek visokotlačne cevi	8	HW1200, HW1300, DHW080	
	197850-3	Podaljšek visokotlačne cevi	10	HW1200, HW1300, DHW080	
	2620551	Visokotlačna cev 8m	8	HW130	
	40808	Visokotlačna cev	7,5	HW130	
	40809	Visokotlačna cev	15	HW131	
	3640960	Visokotlačna cev	8	HW132	



## Podaljški

	Koda	Naziv	Za model	Cena z DDV
	40057	Podaljšek krtače	HW101, HW102, HW110, HW111, HW112, HW130, HW131, HW132, HW140, HW151	
	3320130	Podaljšek	HW102, HW111, HW112	
	40720	Podaljšek sulice	HW110, HW130	
	3718	Cev za vročo vodo	HW120	

[Nadaljevanje...](#)

# Pribor orodja za uporabo na prostem

319

Koda	Naziv	Za model	Cena z DDV	
197867-6	Vrtljiva spojka	HW1200, HW1300, DHW080		
197870-7	Nastavljiva cev	HW1200, HW1300, DHW080		
40029	Sulica z glavo	HW140		

Akumulat  
orj in  
polnilniki

Pribor za  
akumulat  
orsko  
svetilke  
in pribor

Akumulat  
orske  
svetilke  
in pribor

Pribor za  
lasarske  
merilnike

Pribor za  
rušenje  
in vrtanje

Pribor za  
vrtanje

Kronske  
žage

Pribor za  
vijačenje

Pribor za  
rezanje  
in  
brušenje

Pribor za  
poliranje  
in  
brušenje

Pribor za  
rezkanje  
in  
oblanje

Pribor za  
multifunk  
ciljsko  
orodje

Pribor za  
žaganje

Pribor za  
žebjalnike  
in  
spenjalnike

Pribor za  
fene

Pribor za  
sesanje

Pribor  
za  
šobne  
in  
zaščitna  
oprema

Pribor za  
kovčki in  
torbe za  
orodje



Ročno  
orodje

Razno  
orodje

Pribor za  
mešanje

## Krtače



Koda	Naziv	Za model	Cena z DDV	
41185	Krtača za pranje	HW101, HW110, HW130, HW102, HW140, HW151		
41187	Vrtljiva krtača	HW102, HW111, HW112, HW132, HW140, HW151		
197828-6	Krtača za pranje	HW1200, HW1300, DHW080		
197831-7	Vrtljiva krtača	HW1200, HW1300, DHW080		
197864-2	Čistilec tal	HW1200, HW1300, DHW080		

## Šobe in dodatki

Koda	Naziv	Za model	Cena z DDV	
3541	Kovinska igla za čiščenje šob	/		

127104-4

Shranjevalnik vode

DHW080



[Nadaljevanje...](#)

# Pribor orodja za uporabo na prostem

	Koda	Naziv	Za model	Cena z DDV
Akumulat orji in polnilniki				
Pribor za akumulat orsko orodje	191U86-2	Šoba - variabilna	DHW080, HW1200, HW1300	
Akumulat orske svetilke in pribor	191U88-8	Komplet šoba in podaljšek	DHW080, HW1200, HW1300	
Pribor za lasarske mehanike	199486-4	Pas za nošenje	DVC750, DHW080	
Pribor za rušenje in vrtanje	40798	Šoba - variabilna s sulico	HW101	
Pribor za vrtanje	40800	Šoba s posodo za čistila	HW101	
Kronske žage				
Pribor za vijačenje	3640090	Pršilna šoba s posodo za čistila	HW102	
Pribor za rezanje in brušenje	3640640	Šoba - variabilna s sulico	HW102	
Pribor za poliranje in brušenje	41169	Turbo šoba	HW102, HW111, HW112	
Pribor za rezkanje in oblanje	40794	Turbo šoba	HW110	
Pribor za multitank ciklno orodje	40795	Spodnja šoba	HW110	
Pribor za žebjalnike in spenjalnike	40796	Šoba - variabilna	HW110	
Pribor za fene	40810	Šoba s posodo za čistila	HW110, HW130	
Pribor za sesanje	3640650	Šoba - variabilna s sulico	HW111, HW112	
Pribor orodja za uporabo na prostem	3640670	Šoba za nanašanje čistilnega sredstva	HW111, HW112, HW132	
Pribor za nosenje orodja in zaščitna oprema	3195	Rotacijska šoba	HW120	
Kovčki in torbe za orodje	197822-8	Sulica z glavo	HW1200, HW1300, DHW080	
Ročno orodje	197824-4	Ciklonska šoba	HW1200, HW1300, DHW080	
Razno				
Pribor za mešanje				

[Nadaljevanje...](#)

# Pribor orodja za uporabo na prostem

321

Koda	Naziv	Za model	Cena z DDV	
197853-7	Šoba	HW1200, HW1300, DHW080		
197876-5	Šoba-variabilna s sulico	HW1200, HW1300, DHW080		
197879-9	Nastavek za čiščenje cevi	HW1200, HW1300, DHW080		
197886-2	Pršilna šoba s posodo za čistila	HW1200, HW1300, DHW080		
198909-9	Ukrivljena razpršilna šoba	HW1200, HW1300, DHW080		
40719	Šoba - variabilna	HW130		
40721	Turbo šoba	HW130		
40722	Spodnja šoba	HW130		
40729	Šoba - variabilna s sulico	HW131		
40730	Turbo šoba	HW131		
3640930	Šoba - variabilna s sulico	HW132		
41171	Turbo šoba	HW132		
40246	Šoba - variabilna s sulico	HW140		
41173	Turbo šoba	HW140/HW151		
40551	Šoba - variabilna s sulico	HW151		

- Akumulat orji in polnilniki
- Pribor za akumulat orsko orodje
- Akumulat orske svetilke in pribor
- Pribor za lasarske merilnike
- Pribor za rušenje in vrtanje
- Pribor za vrtanje
- Kronske žage
- Pribor za vijčenje
- Pribor za rezanje in brušenje
- Pribor za poliranje in brušenje
- Pribor za rezkanje in oblanje
- Pribor za multitank ciklo orodje
- Pribor za žaganje
- Pribor za žebjalnike in spenjalnike
- Pribor za fene
- Pribor za sesanje
- Pribor orodja za uporabo na prostem
- Pribor za ročno orodje in zaščitna oprema
- Kovčki in torbe za orodje
- Ročno orodje
- Razno
- Pribor za mešanje





## Čistilci tal

	Koda	Naziv	Za model	Cena z DDV
	41175	Čistilec tal	HW102, HW111, HW112, HW132	
	41849	Čistilec tal s posodo za čistila (22x1,5 adapter)	HW140, HW151	



## Cevi za čiščenje odtokov

Koda	Naziv	Dolžina cevi (m)	Za model	Cena z DDV
197837-5	Cev za čiščenje odtokov	10	HW1200, HW1300, DHW080	
41165	Sesalna cev za čiščenje odtokov	10	HW101, HW102, HW110, HW111, HW112, HW130, HW131, HW132, HW140, HW151	
197840-6	Cev za čiščenje odtokov	15	HW1200, HW1300, DHW080	
41167	Sesalna cev za čiščenje odtokov	16	HW101, HW102, HW110, HW111, HW112, HW130, HW132, HW140, HW151	

## Priključki in filtri

	Koda	Naziv	Za model	Cena z DDV
	197873-1	Visokotlačna cev s funkcijo odsesavanja	HW1200, HW1300, DHW080	
	197881-2	Nastavek za šobo	HW1200, HW1300, DHW080	
	197883-8	Šoba	HW1200, HW1300, DHW080	

[Nadaljevanje...](#)



# Pribor orodja za uporabo na prostem

323

Koda	Naziv	Za model	Cena z DDV	
3082130	Vodni filter	HW102		
3440720	Filter umazanije kolektorja za sesanje vode	HW111		
3640680	Prozorna cev, 0,8 m	HW112		
40725	Hitra spojka za cev	HW		
41161	Vodni filter	HW101, HW102, HW110, HW111, HW112, HW130, HW131, HW132, HW140, HW151		
50713	Vodni filter	HW120		



## Embalaža za čistila

Koda	Naziv	Za model	Cena z DDV	
3640380	Posoda za čistilo	HW132		
3640390	Pokrovček posode za čistilo	HW132		

Akumulat  
orji in  
pnilniki

Pribor za  
akumulat  
orsko  
orodje

Akumulat  
orske  
svetilke  
in pribor

Pribor za  
laserske  
merilnike

Pribor za  
rušenje  
in vrtanje

Pribor za  
vrtanje

Kronske  
žage

Pribor za  
vijačenje

Pribor za  
rezanje  
in  
brušenje

Pribor za  
poliranje  
in  
brušenje

Pribor za  
rezkanje  
in  
oblanje

Pribor za  
multifunk  
ciljsko  
orodje

Pribor za  
žaganje

Pribor za  
žebjalnike  
in  
spenjalnike

Pribor za  
fene

Pribor za  
sesanje

Pribor  
orodja za  
uporabo  
na prostem

Pribor za  
pogoje  
orodja in  
zaščitna  
oprema

Kovčki in  
torbe za  
orodje











Ročno  
orodje

Razno  
orodje

Pribor za  
mešanje

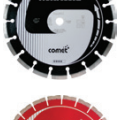
## Motorni rezalniki





## Rezalne plošče

	Koda	Naziv	Makita ID koda	Diamantna plošča (Ø) (mm)	Luknja diamantne plošče (Ø) (mm)	Višina segmenta (mm)	Največje število obratov (min <sup>-1</sup> )	Opis	Debelina plošče (mm)	Rezalna plošča (Ø) (mm)	Cena z DDV
	B-13269	Diamantna rezalna plošča Comet Asphalt	CDA30020	300	20	10	6.360	3DDG, Asphalt			
	B-13459	Diamantna rezalna plošča Quasar	QDS30020 XS	300	20	12	6.400	3DDG, Stealth			
	B-13546	Diamantna rezalna plošča Comet Rapide	CDS30020 RCX	300	20	10	6.400	3DDG, hladilne luknje			
	B-17588	Diamantna rezalna plošča Quasar	QDS30025 XS	300	25,4	12	6.400	3DDG, Stealth			
	B-17619	Diamantna rezalna plošča Comet Rapide	CDS30025 RC	300	25,4	10	6.400	3DDG, hladilne luknje			
	B-54031	Diamantna rezalna plošča Nebula		300	20	10		Lasersko varjen rob			
	B-54047	Diamantna rezalna plošča Nebula		300	20	10		Lasersko varjen rob			
	B-13275	Diamantna rezalna plošča Comet Asphalt	CDA35025	350	25,4/20	10	5.500	3DDG, Asphalt			
	B-13465	Diamantna rezalna plošča Quasar	QDS35025 XS	350	25,4/20	12	5.500	3DDG, Stealth			
	B-13552	Diamantna rezalna plošča Comet Rapide	CDS35025 RCX	350	25,4/20	10	5.550	3DDG, hladilne luknje			
	B-54053	Diamantna rezalna plošča Nebula		350	25,4	10		Lasersko varjen rob			
	E-12790-5	Tanka rezalna plošča A24T 5/1		355	25,4		5.500	ravna	4	355	

Nadaljevanje...

# Pribor orodja za uporabo na prostem

325

Koda	Naziv	Makita ID koda	Diamantna plošča (Ø) (mm)	Luknja diamantne plošče (Ø) (mm)	Višina segmenta (mm)	Največje število obratov (min <sup>-1</sup> )	Opis	Debelina plošče (mm)	Rezalna plošča (Ø) (mm)	Cena z DDV	
E-12996	Diamantna plošča za beton		355	25,4	8	5.500	segmentni rob				
B-13471	Diamantna rezalna plošča Quasar	QDS40025 XS	400	25,4/20	12	4.770	3DDG, Stealth				
B-13568	Diamantna rezalna plošča Comet Rapide	CDS40025 RCX	400	25,4/20	10	4.800	3DDG, hladilne luknje				
B-42905	Diamantna rezalna plošča Comet Asphalt	CDA40025	400	25,4/20	10	4.800	3DDG, Asfalt				
B-54069	Diamantna rezalna plošča Nebula		400	25,4	10		Lasersko varjen rob				

## Ostali pribor

Koda	Naziv	Za model	Cena z DDV	
424789-0	Zračni filter	EK6100, EK6101		
424700-2	Zračni filter	EK7300, EK7301, EK8100		
424701-0	Zračni filter	EK7300, EK7301, EK8100		
957802600	Tlačni vodni rezervoar	EK7301WS, CE001G		
394369610	Voziček za motorne rezalnike z vodnim rezervoarjem, DT400	EK7650H, EK7651H		
195599-9	Set filtrov: 5x predfilter, 1x zračni, 1x prašni	EK7651H		
197980-0	Voziček za motorne rezalnike z vodnim rezervoarjem	EK7651H		

[Nadaljevanje...](#)

Akumulat orji in polnilniki

Pribor za akumulat orodje

Akumulat orske svetilke in pribor

Pribor za lasarske merilnike

Pribor za rušenje in vrtanje

Pribor za vrtanje

Kronske žage

Pribor za vijačenje

Pribor za rezanje in brušenje

Pribor za poliranje in brušenje

Pribor za rezkanje in oblanje

Pribor za multitfunkcijsko orodje

Pribor za žaganje

Pribor za žebjalnike in spenjalnike

Pribor za fene

Pribor za sesanje

Pribor orodja za uporabo na prostem

Pribor za ploščo in orodja za zaščito oprema

Kovčki in torbe za orodje

Ročno orodje

Razno

Pribor za mešanje

# Pribor orodja za uporabo na prostem

	Koda	Naziv	Za model	Cena z DDV
	198172-4	Predfilter	EK7651H	
	442165-6	Zračni filter	EK7651H	
	394365102	Komplet za vodo	EK8100	

## Škropilnice

### Pribor

	Koda	Naziv	Za model	Cena z DDV
	6958028000	Enojna šoba	BVF104, EVH2000	
	6958029000	Dvojna šoba	BVF104, EVH2000	
	6959505801	Brizgalna cev	BVF104RF	
	6909511104	Držalo za cev	BVF104RF, EVH2000	
	6939025000	Kompaktna šoba	BVF104RF, EVH2000	
	6958011000	Šoba za fino razprševanje	BVF104RF, EVH2000	
	6958025000	Dvojna šoba, Y-oblika, širokokotna	BVF104RF, EVH2000	
	6909500100	Trojna koncentrična šoba	EVH2000	
	6919500000	Štirikratna koncentrična šoba	EVH2000	

[Nadaljevanje...](#)



# Pribor orodja za uporabo na prostem

327

Koda	Naziv	Za model	Cena z DDV	
6939024000	Nastavek za dvojno delovanje šobe	EVH2000		
6939028000	Posebni nastavek za dvojno delovanje šobe	EVH2000		
6949001000	Dolga dvojna šoba	EVH2000		
6958018000	Dvojna šoba, U-oblika	EVH2000		
6909511501	Cev škropilnice	EVH2000, EF1551RH		
PR00000128	Ramenski pas	US053D, DUS054		
PR00000142	Šoba	US053D, DUS054		
PR00000144	Plastično držalo	US053D, DUS054		
PR00000145	Cev	US053D, DUS054		
PR00000147	Filter s tesnilom	US053D, DUS054		

Akumulat  
orji in  
polnilniki

Pribor za  
akumulat  
orsko  
orodje

Akumulat  
orske  
svetilke  
in pribor

Pribor za  
lasarske  
merilnike

Pribor za  
rušenje  
in vrtanje

Pribor za  
vrtanje

Kronske  
žage

Pribor za  
vijačenje

Pribor za  
rezanje  
in  
brušenje

Pribor za  
poliranje  
in  
brušenje

Pribor za  
rezkanje  
in  
oblanje

Pribor za  
multifunk  
ciljsko  
orodje

Pribor za  
žaganje

Pribor za  
žebjalnike  
in  
spenjalnike

Pribor za  
fene

Pribor za  
sesanje

Pribor  
orodja za  
uporabo  
na prostem

Pribor za  
pogoje  
orodja in  
zaščitna  
oprema

Kovčki in  
torbe za  
orodje

Ročno  
orodje

Razno

Pribor za  
mešanje

# VRTALNIKI ZA ZEMLJO IN SNEG



Primerno za vrtnanje v peščeno zemljo s koreninami in kamenčki.  
Uporablja se pri površinskem gnojenju, sajenju dreves in pripravi izvrtin za količenje.

## SVEDRI ZA VRTANJE

Premer	Dolžina	Delovna dolžina	Koda
ø50 mm			E-13611
ø60 mm			E-13627
ø80 mm	800 mm	550 mm	E-13633
ø100 mm			E-07294
ø150 mm			E-07303
ø200 mm			E-07319

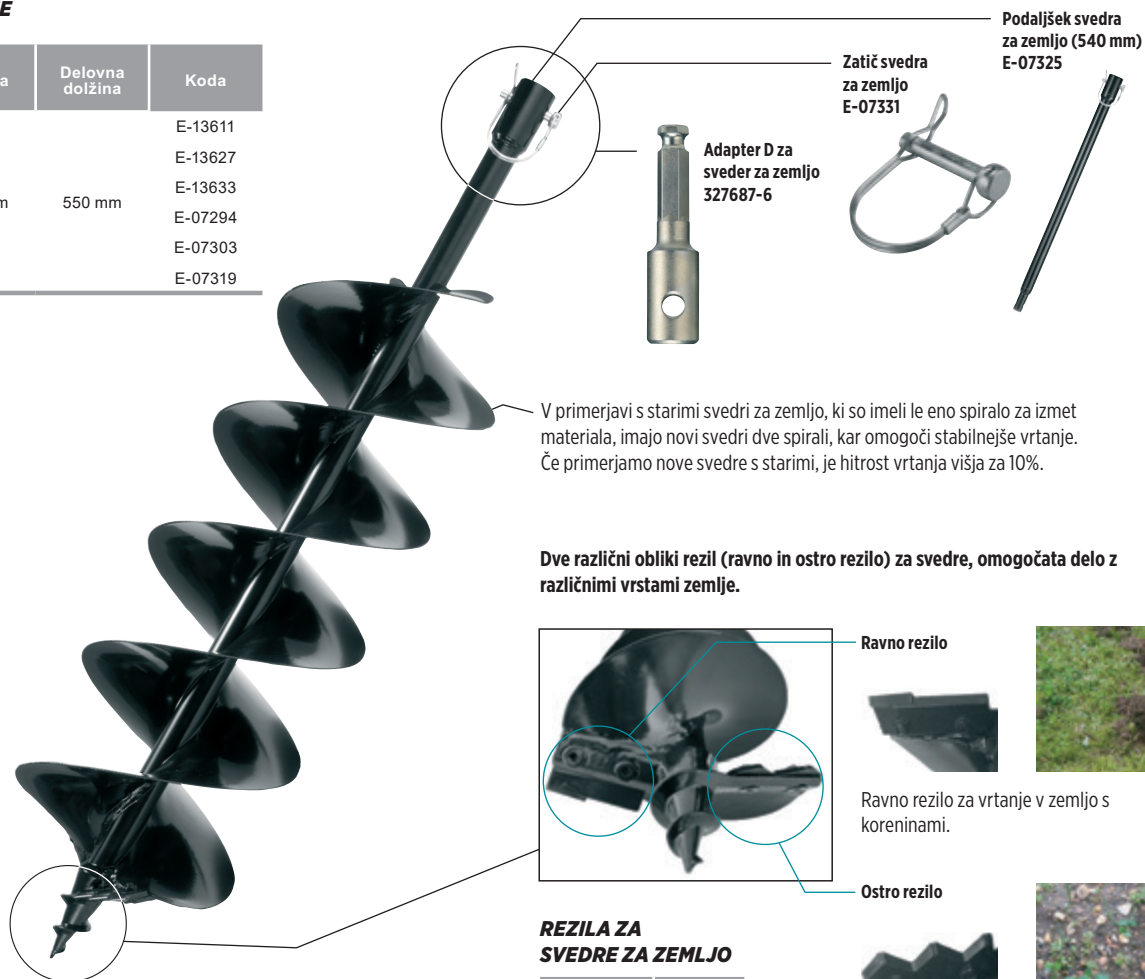

**Zatič svedra za zemljo E-07331**

**Adapter D za sveder za zemljo 327687-6**

**Podaljšek svedra za zemljo (540 mm) E-07325**

V primerjavi s starimi svedri za zemljo, ki so imeli le eno spiralo za izmet materiala, imajo novi svedri dve spirali, kar omogoči stabilnejše vrtnanje. Če primerjamo nove svedre s starimi, je hitrost vrtnanja višja za 10%.

**Dve različni obliki rezil (ravno in ostro rezilo) za svedre, omogočata delo z različnimi vrstami zemlje.**

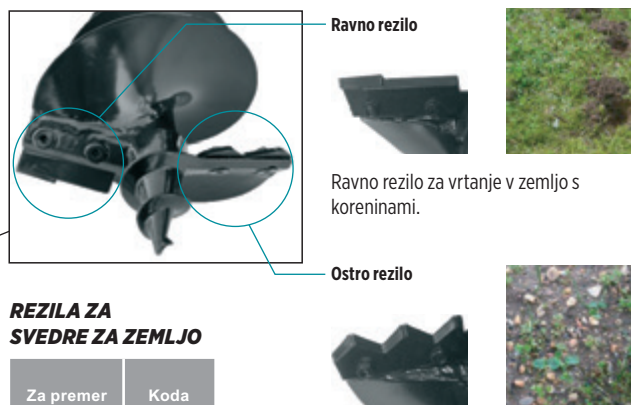

**Ravno rezilo**

Ravno rezilo za vrtnanje v zemljo s koreninami.

**Ostro rezilo**

Ostro rezilo za vrtnanje v zemljo s kamenčki.

## REZILA ZA SVEDRE ZA ZEMLJO

Za premer	Koda
50 mm	E-13649
60 mm	E-13655
80 mm	E-13661
100 mm	E-07630
150 mm	E-07646
200 mm	E-07652

## ROČAJ VRTALNIKA ZA ZEMLJO

Koda	Za model
191P11-3	DG001G, DDG460

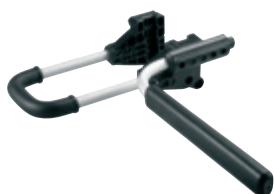













\*Sveder premera 200 mm je primeren le za vrtnanje v peščeno zemljo.

# PRIBOR ZA NOŠENJE ORODJA IN ZAŠČITNA OPREMA



## Pribor za nošenje orodja

## Pribor za nošenje orodja in pribora

	Koda	Naziv	Za model	Cena z DDV
	127778-1	Kavelj za DDA450	DDA450	
	191C05-0	Obešalni kavelj	JR3051	
	191F45-6	Obešalni kavelj	HR3011FC, HR3012FC, HR3001C	
	191G64-8	Obešalni kavelj	DPB183,DPB184	
	191K57-9	Obešalni kavelj vijahnika DTD157	DTD157	
	191W90-3	Obešalni kavelj	HR007G	
	197043-2	Obešalni kavelj vijahnika	DTD134, DTD137, DTD146, DTD148, DTD153, DTD154, DTD155, DTD170, DTS130, DTS131, DTS141, DTW152	
	197224-8	Obešalni kavelj za akumulatorska kladiva	DCS551, DHR171, DSD180, HR166D, SD100D	
	197941-0	Nosilni pas z obešalnimi kavljem	DTW190	
	199231-7	Obešalni kavelj za akumulatorske žage	DHS660, DHS661	
	199296-9	Obešalni kavelj	DCS553	
	199386-8	Obešalni kavelj	DHS780, DHS781, DHS782, DHS783	



[Nadaljevanje...](#)

- Akumulat orji in polnilniki
- Pribor za akumulat orsko orodje
- Akumulat orske svetilke in pribor
- Pribor za laserske merilnike
- Pribor za rušenje in vrtanje
- Pribor za vrtanje
- Kronske žage
- Pribor za vijačenje
- Pribor za rezanje in brušenje
- Pribor za poliranje in brušenje
- Pribor za rezkanje in oblanje
- Pribor za multitank cijsko orodje
- Pribor za žaganje
- Pribor za žebjalnike in spenjalnike
- Pribor za fene
- Pribor za sesanje
- Pribor orodja za uporabo na prostem
- Pribor za nošenje orodja in zaščitna oprema
- Kovčki in torbe za orodje
- Ročno orodje
- Razno
- Pribor za mešanje



# Pribor za nošenje orodja in zaščitna oprema

331

Koda	Naziv	Za model	Cena z DDV	
346317-0	Obešalni kavelj za akumulatorske vijačnike/vrtalnike	/		
346449-3	Obešalni kavelj za akumulatorske vijačnike/vrtalnike	/		
346949-3	Obešalni kavelj	DTW1001, DTW1002, TW001G, TW007G		

## Zaščitna oprema

### Zaščitna očala

Koda	Naziv	Cena z DDV	
192219-6	Zaščitna očala		
AL00000147	Zaščitna očala		

Akumulat  
orj in  
polnilniki

Pribor za  
akumulat  
orsko  
orodje

Akumulat  
orske  
svetilke  
in pribor

Pribor za  
laserske  
merilnike

Pribor za  
rušenje  
in vrtanje

Pribor za  
vrtanje

Kronske  
žage

Pribor za  
vijačenje

Pribor za  
rezanje  
in  
brušenje

Pribor za  
poliranje  
in  
brušenje

Pribor za  
rezkanje  
in  
oblanje

Pribor za  
multifunk  
cijsko  
orodje

Pribor za  
žaganje

Pribor za  
žebjalnike  
in  
spenjalnike

Pribor za  
fene

Pribor za  
sesanje

Pribor  
orodja za  
uporabo  
na prostem

Pribor za  
orožja in  
zaščitna  
oprema

Kovčki in  
torbe za  
orodje

Ročno  
orodje

Razno

Pribor za  
mešanje



# KOVČKI IN TORBE ZA ORODJE



# Strap Belt sistem

## Uporabi kot ramenski pas

STRAP BELT SISTEM je edinstven trak s hitrima zaponkama za multifunkcijsko uporabo. Trak je opremljen z ramensko podlogo iz mehke gume za večje udobje pri dvigovanju in nošenju.



## Uporabi kot pas

STRAP BELT trak se lahko enostavno odpre iz katere koli torbe in uporabi kot pas za orodje. Odlikujejo ga enostavno prilagajanje velikosti za maksimalno udobje in možnost kombiniranja s katerim koli držalom in etujem iz STRAP BELT sistema.



**E-05446**  
Torba za orodje s snemljivim pokrovom



**E-05418**  
Torba za orodje z nastavljivimi notranjimi predeli



**E-05620**  
Torba izolirana za malico z naramnim trakom



**E-05614**  
Torba izolirana za malico



**E-05256**  
Univerzalno držalo orodja



**E-05212**  
Etui za električarje nastavljiv



**E-05480**  
Torbica za orodje 4 stranska uporaba



**E-05474**  
Univerzalna torbica za na ramo ali pas

**STRAP BELT SYSTEM**



**Več kot 40**  
**kompatibilnih artiklov**



**E-05153**  
Torbica za krovce



**E-05228**  
Etui za ročno orodje nastavljiv



**E-05234**  
Stransko držalo kladivo in orodja



**E-05240**  
Držalo kladiva, sekire



**E-05583**  
Etui za mobilni telefon



**E-12980**  
Etui za mobilni telefon XL



**E-05549**  
Torbica za motorne žage



**E-10920/E-10936**  
Torbica za vodilno letev 1,9 m/3 m



**E-05670/E-05664**  
Transportna torbica za vodila do 1 m/1,5 m



**E-05505**  
Torba za prenosnik in ročno orodje



**E-05561**  
Torba večnamenska z navitjem



**E-05206**  
Torbica z zadrgo za baterije ali pribor



**E-05496**  
Torba za orodje univerzalna



**E-05094**  
Torbica za vijaknike L/D



**E-05119**  
Torbica za vijaknike in pribor L/D



**E-05197**  
Torbica univerzalna z držalom za kladivo



**E-05181**  
Torbica za električarje



**E-05608**  
Termo skodelica z držalom za pas



**E-05599**  
Termovka z držalom za pas - INOX



**E-05262**  
Etui za nož ali vrtno škarje



**E-05147**  
Večnamenska torbica s 3 predali

## 3. generacija tehničnih rešitev Makita torb in držal

### STRAP BELT SYSTEM

**Strap Belt sistem** je edinstven trak s hitrima zaponkama, ki se ga enostavno odpne iz katere koli torbe in uporabi kot pas za orodje. Trak je kompatibilen z vsemi torbami, držali za orodje in etuiji iz sistema.



### 3 LAYERS

**3-L tehnologija** je edinstven 3-slojni kompozit iz poliestra in pene, ki zagotavlja izjemno trpežnost, vodoodpornost in nizko težo. Njegova inovativna struktura omogoča enostavno oblikovanje v različne strukture.

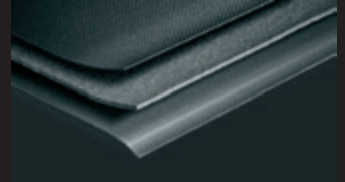

### WATERPROOF BOTTOM

**Vodoodporno dno** je izjemnega pomena za kvaliteten nabor torb za orodje. Trdno, trpežno in vodoodporno dno ščiti torbo in orodje pred vodo in umazanijami.



### REAL LEATHER

**Pravo usnje** je gladko na zunanji strani in brušeno na notranji strani. Odlikujeta ga trdnost in visoka trpežnost za dolgo življensko dobo, medtem ko je dovolj mehko in voljno za udobno nošenje. Za izdelke, ki so še posebej izpostavljeni obrabi smo uporabili debelejša usnje - 1,8 - 2 mm - ter s tem zagotovili vrhunsko kvaliteto produktov čez celoten nabor.



### DURABLE RIVETING

**Trpežno kovičenje** za izjemno močne spoje. Na delih pod visokimi obremenitvami so uporabljene vzdržljive zakovice s podložko. Pri določenih spojih, kjer je potrebna visoka trpežnost sta uporabljeni 1 ali 2 podložki; na eni strani ali obeh straneh.



### ANTI SLIP

**Proti-zdrsna zaščita** znižuje možnost oz. preprečuje nesreče na delovišču. Visoko kvaliteten polipropilenski trak z gumirano površino poskrbi, da vaše orodje ostane na mestu ter dodatno ščiti ohišje pred poškodbami.



### ELASTIC LOOPS

**Elastične zanke** držijo vaše orodje in pribor, na mestu, za varen transport. Njihova prilagodljivost vam ponuja neskončno možnosti za organiziranje, medtem ko njihova elastičnost poskrbi, da se optimalno prilagodijo kateremu koli orodju ali priboru. Elastične zanke smo implementirali na čim več naših produktov za maksimalno uporabnost vsakega izmed produktov.



















### SIDE-GATE SOLUTION

**Klik-držalo** za enostavno pripenjanje kladiva/sekire, ki omogoča da hitro in brez spreminjanja pogleda pripnete/izvlečete orodje. Sistem na princip nihajnih vrat poskrbi da je vaše orodje vedno pod ugodnim kotom. Držalo je izdelano iz nerjavečega jekla in pritrjeno z 4 zakovicami za visoko trpežnost in dolgo življensko dobo.





















## Torbice in držala

Model	Opis	Velikost (mm)			Posebne lastnosti								
		V	D	Š	STRAP/BELT SYSTEM	3 LAYERS	WATERPROOF BOTTOM	REAL LEATHER	DURABLE RIVETING	ANTI SLIP	ELASTIC LOOPS	SIDE-GATE SOLUTION	
	E-05094 Torba za vijakove L/D	290	170	85	✓	✓		✓	✓	✓	✓		
	E-05119 Torba za vijakove in pribor L/D	235	155	75	✓	✓		✓	✓	✓	✓		
	E-05125 Torba za vrtalnike in pribor L/D	270	260	145	✓	✓		✓	✓	✓	✓		
	E-05147 Večnamenska torba s 3 predali	270	320	145	✓	✓		✓	✓	✓	✓		
	E-05153 Torba za krovce	270	290	145	✓	✓		✓	✓	✓	✓	✓	
	E-05169 Set 3 torbic na pasu z dvema dodatnima zaponkama	270	640	145		✓		✓	✓	✓	✓	✓	
	E-05175 Usnjen dvojni pas s torbicami in držali za orodje	310	880	170	✓	✓		✓	✓	✓	✓		
	E-05181 Torba za električarje	310	250	125	✓	✓		✓	✓	✓	✓		
	E-05197 Univerzalna torba z držalom za kladivo	185	180	105	✓	✓		✓	✓	✓	✓		
	E-05206 Torba z zadrgo za akumulatorje ali pribor	185	175	105	✓	✓			✓		✓		
	E-05212 Etui za električarje nastavljen	205	185	55	✓			✓	✓		✓		
	E-05228 Etui za ročno orodje nastavljen	205	185	85	✓			✓	✓		✓		
	E-05234 Stransko držalo kladiva in orodja	165	110	70	✓	✓			✓		✓	✓	
	E-05240 Držalo kladiva, sekire	165	110	65	✓	✓			✓		✓		
	E-05256 Univerzalno držalo orodja	165	110	15	✓	✓			✓		✓		
	E-05262 Etui za nož ali vrtno škarje	200	100	50	✓	✓			✓	✓	✓		

## Pasovi in naramnice

Model	Opis	Velikost (mm)			Posebne lastnosti											
		V	D	Š	STRAP/BELT SYSTEM	3 LAYERS	WATERPROOF BOTTOM	REAL LEATHER	DURABLE RIVETING	ANTI SLIP	ELASTIC LOOPS	SIDE-GATE SOLUTION				
	E-05290	Hitro odpenjalni pas / naramni trak	38	1.300	-	✓										
	E-05309	Dodatna zaponka (pk/3kos)	129	41	-	✓										
	E-05321	Usnjen dvojni pas podložen z dodatno zaponko	100	880	30				✓	✓						
	E-05337	Hitro odpenjalni pas	50	1.550	-											
	E-05343	Usnjen dvojni pas z dodatno zaponko	48	1.380	-				✓							
	E-05359	Usnjen pas črn M	38	1.130	-				✓							
	E-05365	Usnjen pas črn L	38	1.330	-											
	E-05371	Usnjen pas rjav M	38	1.130	-				✓							
	E-05387	Usnjen pas rjav L	38	1.330	-											
	E-05393	Naramnice podložene za podporo	410	520	23						✓					
	E-05402	Naramnice Makita univerzalna velikost	-	50	-											

## Torbe, etuji in nahrbtniki

Model	Opis	Velikost (mm)			Posebne lastnosti											
		V	D	Š	STRAP/BELT SYSTEM	3 LAYERS	WATERPROOF BOTTOM	REAL LEATHER	DURABLE RIVETING	ANTI SLIP	ELASTIC LOOPS	SIDE-GATE SOLUTION				
	E-05418	Torba za orodje z nastavljivimi notranjimi predeli	310	510	300	✓		✓		✓		✓				
	E-05446	Torba za orodje s snemljivim pokrovom	360	490	310	✓		✓		✓		✓				
	E-05474	Univerzalna torbica za na ramo ali pas	225	350	175	✓	✓				✓	✓				
	E-05480	Torbica za orodje 4 stranska uporaba	410	260	220	✓				✓	✓	✓				
	E-05496	Univerzalna torba za orodje	270	520	250	✓	✓				✓	✓				
	E-05505	Torba za prenosnik in ročno orodje	350	425	170	✓	✓			✓		✓				





## Makpac notranje podloge

	MODEL ORODJA	PODLOGA	MAKPAC KOVČEK	MODEL ORODJA	PODLOGA	MAKPAC KOVČEK	MODEL ORODJA	PODLOGA	MAKPAC KOVČEK
Akumulat orji in polnilniki	1911B	837878-6	3	DCS551	838269-4	3	DHP446	837916-4	2
Pribor za akumulat orsko orodje	3708F	837674-2	2	DDA340	838040-6	2	DHP448	837916-4	2
Akumulat orske svetilke in pribor	3710	837674-2	2	DDA350	838040-6	2	DHP453	837916-4	2
Pribor za laserske merilnike	4100KB	839436-4	4	DDA351	838040-6	2	DHP456	837916-4	2
Pribor za rušenje in vrtanje	4329	837803-7	1	DDA341	838040-6	2	DHP458	837916-4	2
Pribor za vrtanje	4350CT	837803-7	1	DDF+DTD	837864-7	3	DHP459	837916-4	2
Kronske žage	4351CT	837803-7	1	DDF+DHR	838095-1	4	DHP470	837916-4	2
Pribor za vijačenje	5008MG	837657-2	4	DDF083	837670-0	2	DHP480	837916-4	2
Pribor za rezanje in brušenje	6413	838030-9	1	DDF343	837916-4	2	DHP481	837916-4	2
Pribor za poliranje in brušenje	6842	837876-0	1	DDF446	837916-4	2	DHP482	837916-4	2
Pribor za rezkanje in oblanje	6843	837876-0	1	DDF448	837916-4	2	DHP483	837670-0	2
Pribor za multifunkcijsko orodje	6906	838024-4	2	DDF453	837916-4	2	DHP484	837916-4	2
Pribor za žaganje	9046	838025-2	2	DDF456	837916-4	2	DHP485	837916-4	2
Pribor za žabljanke in spenjalnike	9403	837652-2	3	DDF458	837916-4	2	DHR162	838109-6	3
Pribor za fene	9404	837653-0	3	DDF459	837916-4	2	DHR164	838109-6	3
Pribor za sesanje	9741	838026-0	3	DDF470	837916-4	2	DHR165	838109-6	3
Pribor za uporabo na prostem	9910	837658-0	3	DDF480	837916-4	2	DHR171	839387-1	3
Kovčki in torbe za orodje	9911	837658-0	3	DDF481	837916-4	2	DHR202	837634-4	3
Ročno orodje	BBO140	837809-5	2	DDF482	837916-4	2	DHR241	837641-7	3
Razno	BDF441	837916-4	2	DDF483	837670-0	2	DHR242	835A31-4	4
Pribor za mešanje	BDF451	837916-4	2	DDF484	837916-4	2	DHR242	837649-1	4
	BDF452	837916-4	2	DDF485	837916-4	2	DHR243	835A31-4	4
	BDF454	837916-4	2	DF+TD	838439-5	1	DHR243	837649-1	4
	BHP441	837916-4	2	DF001G	835F93-2	3	DHR263	837988-9	4
	BHP451	837916-4	2	DF002G	835U77-0	2	DHR263+DDF	838316-1	4
	BHP452	837916-4	2	DF010D	837871-0	1	DHR263+DHP	838316-1	4
	BHP454	837916-4	2	DF030D	837866-3	1	DHR264	837988-9	4
	BHR162	838109-6	3	DF031D	838312-9	1	DHR280	835A32-2	4
	BHR242	835A31-4	4	DF033D	838312-9	1	DHR280	839559-8	4
	BHR243	835A31-4	4	DF330D	837866-3	1	DHR281	839559-8	4
	BHR262	837650-6	4	DF331D	838312-9	1	DHR282	839559-8	4
	BJN160	837678-4	2	DF332D	838312-9	1	DHR283	839559-8	4
	BO4555	838029-4	2	DF333D	838312-9	1	DHS630	837635-2	4
	BO4565	838029-4	2	DF347D	838267-8	2	DHS660	839752-4	3
	BO4900V	837675-0	2	DFN350	835B51-4	2	DHS661	839752-4	3
	BO4901	837675-0	2	DFR440	837631-0	3	DHS680	838182-6	3
	BO5031	837874-4	2	DFR540	837631-0	3	DHS710	837861-3	4
	BO5041	837874-4	2	DFR550	837631-0	3	DHS782	835C85-3	4
	BO6030	837654-8	3	DFS250	837805-3	2	DHS783	835C85-3	4
	BO6040	837655-6	3	DFS251	837805-3	2	DJN161	837678-4	2
	BO6050	838246-6	3	DFS441	837805-3	2	DJR183	837897-2	2
	BPJ140	837648-3	3	DFS451	837805-3	2	DJR188	839458-4	3
	BSS500	837628-9	3	DFS452	837805-3	2	DJS101	837636-0	2
	BSS501	837628-9	3	DGA450	837632-8	3	DJS130	838302-2	2
	BTP130	837670-0	2	DGA452	837632-8	3	DJS160	837636-0	2
	CA5000	838390-9	4	DGA504	838175-3	3	DJS161	837636-0	2
	CC300D	837879-4	3	DGA504	839252-4	3	DJV140	837639-4	2
	CC301D	838568-4	3	DGA504	839355-4	3	DJV180	837639-4	2
	DA3010F	837880-9	1	DGA506	838175-3	3	DJV181	837789-5	3
	DA3011F	837880-9	1	DGA508	838175-3	3	DJV182	837639-4	2
	DA330D	837695-4	1	DGA511	839252-4	3	DKP180	837808-7	3
	DA331D	837695-4	1	DGA513	839252-4	3	DKP181	835E27-9	3
	DA332D	839304-1	1	DGA514	839252-4	3	DP2010	838030-9	1
	DA333D	839304-1	1	DGA517	839252-4	3	DP2011	838030-9	1
	DBO140	837809-5	2	DGA519	839252-4	3	DP3003	838039-1	1
	DBO180	837809-5	2	DGD800	837806-1	2	DP4001	838039-1	1
	DCO180	838062-6	1	DHK180	835D35-4	4	DP4003	838039-1	1
	DCS550	837628-9	3	DHP343	837916-4	2	DP4011	838039-1	1

# Makpac notranje podloge

MODEL ORODJA	PODLOGA	MAKPAC KOVČEK
DP4700	837872-8	1
DPJ180	837648-3	3
DPT350	837640-9	2
DPT351	837640-9	2
DPT353	839128-5	2
DPV300	835V03-5	2
DRT50	837247-1	4
DRV150	835A34-8	3
DRV250	835A34-8	3
DS4012	838181-8	3
DSC102	839527-1	3
DSP600	839290-6	4
DSP601	839290-6	4
DSS610	837642-5	3
DST110	837640-9	2
DST220	837640-9	2
DST221	837640-9	2
DTD129	837670-0	2
DTD134	837670-0	2
DTD136	837670-0	2
DTD137	837670-0	2
DTD146	837670-0	2
DTD147	837670-0	2
DTD148	837670-0	2
DTD152	837670-0	2
DTD153	837670-0	2
DTD154	837670-0	2
DTD170	837670-0	2
DTL060	837644-1	2
DTL061	837644-1	2
DTL062	837644-1	2
DTL063	837644-1	2
DTM50	837671-8	3
DTM51	837671-8	3
DTM52	835W93-4	3
DTP131	837670-0	2
DTP140	837670-0	2
DTP141	837670-0	2
DTR180	839735-4	4
DTS130	837670-0	2
DTS141	837670-0	2
DTW1001	837645-9	3
DTW1002	837645-9	3
DTW181	837298-4	2
DTW181	837670-0	2
DTW190	838550-3	2
DTW250	837670-0	2
DTW251	837670-0	2
DTW281	837670-0	2
DTW285	837670-0	2
DTW300	835L10-8	2
DTW301	835L10-8	2
DTW450	837645-9	3
DTW800	837645-9	3
FS2300	838030-9	1
FS2500	838030-9	1
FS2700	838030-9	1
FS4000	838030-9	1

MODEL ORODJA	PODLOGA	MAKPAC KOVČEK
FS4300	838030-9	1
FS6300	838030-9	1
GA005G	835E79-0	4
GA008G	835E79-0	4
GA023G	835E79-0	4
GA029G	835E79-0	4
GA5030	837920-3	2
GA5040	837672-6	2
GA5041	837672-6	2
HPO02G	835U77-0	2
HP1630	838038-3	1
HP1631	838038-3	1
HP1640	838038-3	1
HP1641	838038-3	1
HP2050	838039-1	1
HP2051	838039-1	1
HP2070	838039-1	1
HP2071	838039-1	1
HP330D	837866-3	1
HP331D	838312-9	1
HP332D	838312-9	1
HP333D	838312-9	1
HR002G	835C84-5	4
HR004G	835C84-5	4
HR140D	839245-1	2
HR166D	839245-1	2
HR1841F	839214-2	1
HR2300	837651-4	2
HR2600	837651-4	2
HR2610	837651-4	2
HR2611FT	837914-8	2
HR2630T	837914-8	2
HR2631FT	837914-8	2
HR2652	839975-4	4
HR2811FT	837868-9	2
HR3001	835B26-3	2
HR3011	835B25-5	4
HR3012FC	835B25-5	4
HS003G	835K81-9	4
HS004G	835K82-7	4
HS300D	837662-9	2
HS301D	838315-3	2
HS6101	837807-9	4
HS6601	838314-5	3
HS7101	837807-9	4
HS7601	838108-8	4
HS7611	839500-1	4
JN1601	837882-5	1
JN3201	837630-2	2
JR100D	837664-5	1
JR102D	837664-5	1
JS1000	838027-8	1
JS1601	838027-8	1
JS1602	837882-5	1
JS3201	837630-2	2
JV0600	837803-7	1
JV100D	837665-3	1
JV101D	838563-4	1

MODEL ORODJA	PODLOGA	MAKPAC KOVČEK
JV102D	839186-1	1
JV103D	839186-1	1
KP0800	837659-8	3
KP0810	837659-8	3
PJ7000	837661-1	3
PT354D	839166-7	1
RP0900	837646-7	2
RP0910	837660-3	2
RP1110C	837660-3	2
RP1800	837647-5	4
RP1801	837647-5	4
RP1803F	8352F0-3	4
RP2300	837647-5	4
RP2301	837647-5	4
RP2303FC	8352F0-3	4
RT0700C	837247-1	4
SA5040C	837672-6	2
SG1251	838111-9	4
SP001G	8351E4-2	4
SP6000	837945-7	4
SP6000	838390-9	4
ST113D	839019-0	1
TD001G	835F94-0	2
TD021D	837871-0	1
TD090D	837866-3	1
TD110D	838312-9	1
TD111D	838312-9	1
TL064D	839287-5	1
TL065D	839287-5	1
TM3000	837673-4	2
TM30D	838612-7	2
TW001G	835K85-1	3
TW007G	835K85-1	3
TW0200	837869-7	1
TW0350	837870-2	2
TW100D	837866-3	1
TW161D	838312-9	1

MODEL ORODJA	PODLOGA	PLASTIČEN KOVČEK
HR4003C	837544-5	196277-4
HR4013C	837544-5	196278-2
HR5202C	837860-5	196552-8
HR5212C	837860-5	196553-6

PRIBOR	PODLOGA	MAKPAC KOVČEK
LXT akumulator + polnilnik	837948-1	1
4x LXT akumulator + polnilnik	838110-1	1
4x LXT akumulator + dvojni polnilnik	839205-3	3
8x LXT akumulator	839742-7	1, 2, 3, 4

- Akumulatorji in polnilniki
- Pribor za akumulatsko orodje
- Akumulatorne svetilke in pribor
- Pribor za laserske merilnike
- Pribor za rušenje in vrtanje
- Pribor za vrtanje
- Kronске žage
- Pribor za vijčenje
- Pribor za rezanje in brušenje
- Pribor za poliranje in brušenje
- Pribor za rezkanje in oblanje
- Pribor za multifunkcijsko orodje
- Pribor za žaganje
- Pribor za žebjanike in spenjalnike
- Pribor za fene
- Pribor za sesanje
- Pribor za uporabo na prostem
- Pribor za nosenje in zaščitna oprema
- Kovčki in torbe za orodje
- Ročno orodje
- Razno
- Pribor za mešanje

## MAKPAC KOVČKI

- ▶ 4 različne velikosti kovčkov za shranjevanje orodja in pribora
- ▶ Možnost sestavljanja z ostalimi kovčki v Makpac sistemu

**821549-5** Makpac 1  
395×295×105 mm

**821550-0** Makpac 2  
395×295×155 mm

**821551-8** Makpac 3  
395×295×215 mm

**821552-6** Makpac 4  
395×295×315 mm

**453974-8** Plastična zaponka



## MAKPAC KOVČKI S PREDALI

- ▶ Možnost sestavljanja z ostalimi kovčki v Makpac sistemu

**P-84311** Makpac 3  
395×295×215 mm



**P-84327** Makpac 3  
395×295×215 mm



**P-84333** Makpac 3  
395×295×215 mm



**P-84349** Makpac 4  
395×295×315 mm



## MAKPAC ORGANIZATORJI

- ▶ Možnost premikanja posod za poljubno razporeditev
- ▶ S transparentnim pokrovom
- ▶ S stranskimi ročaji za enostavno prenašanje

**191X80-2**  
Makpac 1 organizator s prilagodljivimi posodami  
395×295×110 mm



**191X84-4**  
Makpac 1 organizator brez posod  
395×295×110 mm

③=①×4		③=①×4	④=①×6
①	①	②=①×2	
①	①	②=①×2	⑤=①×9
①	①	②=①×2	

## MAKPAC POSODE ZA ORGANIZATORJE

**191X92-5** Set notranjih posod št. 1-5

**191X95-9** Notranja posoda št. 3  
100×100 mm

**191X93-3** Notranja posoda št. 1  
150×50 mm

**191X96-7** Notranja posoda št. 4  
150×100 mm

**191X94-1** Notranja posoda št. 2  
100×50 mm

**191X97-5** Notranja posoda št. 5  
150×150 mm

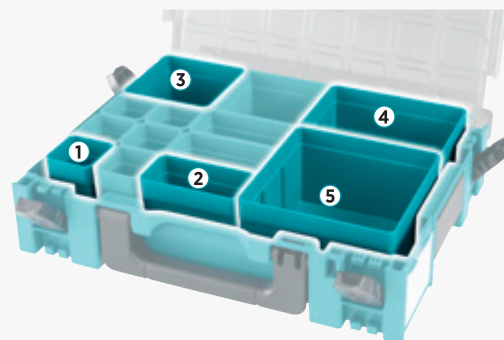

## MAKPAC ZABOJI

- ▶ Možnost sestavljanja zabojev med seboj
- ▶ Možnost pripenjanja na Makpac kovčke

**P-83836** 395×295×145 mm  
**P-83842** 395×295×250 mm

**P-84137** 395×295×165 mm



## MAKPAC HLADILNI KOVČKI

- ▶ Možnost sestavljanja z ostalimi kovčki v Makpac sistemu

**198254-2** Makpac 3 - 11 l  
395×295×215 mm



**198253-4** Makpac 4 - 18 l  
395×295 × 315 mm



# Makpac povezljiv sistem

## PODLOGE ZA MAKPAC KOVČKE

► Priporočamo uporabo z Makpac kovčkom 1, saj njegova višina zagotovi dobro prileganje podloge in prepreči premikanje shranjenega pribora.



**P-84268**

Prilagodljiva pena za akumulatorje s peno za pokrov

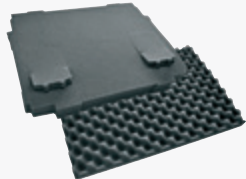

**P-83705**

Notranja prilagodljiva pena, 30 mm

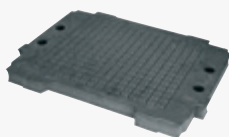

**198978-0**

Pena za pokrov Makpac kovčkov

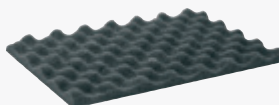

**P-83652**

Notranja podloga z barvnimi posodami s peno za pokrov

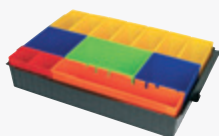

**P-83696**

Notranja podloga za pribor z 9 nastavljenimi prekatmi



**P-83674**

Univerzalna notranja podloga za pribor s peno za pokrov



**839742-7**

Notranja podloga za 8x LXT akumulatorjev



**P-83668**

Notranja podloga za pribor



**P-83680**

Notranja podloga za pribor s 6 nastavljenimi prekatmi



## MAKPAC TRANSPORTNI VOZIČKI

**TR00000001**

Transportni voziček za Makpac kovčke 270-565x500x725-1125 mm

- Robustna aluminijasta konstrukcija
- Zložljiva transportna površina
- Nastavljiv jermen
- Največja obremenitev: 125 kg (ravna površina), 60 kg (stopnice)



**P-83886**

Voziček za Makpac kovčke 360x520x158 mm

- Dve pozicije za zaklepanje kovčka
- 360° vrtljiva kolesa, dva s parkirnimi zavori
- Največja obremenitev: 100 kg



## MAKPAC NOSILCI ZA SESALNIKE

Za varno pritrditev kovčkov Makpac na Makita sesalnik.

**W107418357**

Za sesalnik: VC4210



Za varno pritrditev kovčkov Makpac na Makita sesalnike.

**198599-8**

Za sesalnik: VC2211/ VC3210/ VC3211



## MAKPAC RAMENSKI TRAK

**161576-3**

Ramenski trak za Makpac kovčke



Akumulat orji in polnilniki  
 Pribor za akumulat orsko orodje  
 Akumulat orske svetilke in pribor  
 Pribor za laserske merilnike  
 Pribor za rušenje in vrtanje  
 Pribor za vrtanje  
 Kronske žage  
 Pribor za vijčanje  
 Pribor za rezanje in brušenje  
 Pribor za poliranje in brušenje  
 Pribor za rezkanje in oblanje  
 Pribor za multitank ciljsko orodje  
 Pribor za žaganje  
 Pribor za žaganje  
 Pribor za žebjalnike in spenjalnike  
 Pribor za fene  
 Pribor za sesanje  
 Pribor za uporabo na prostem  
 Pribor za nosenje orodja in zaščitna oprema  
 Kovčki in torbe za orodje  
 Ročno orodje  
 Razno  
 Pribor za mešanje



## Kovčki in torbe za orodje

	MODEL	KODA	TIP	MODEL	KODA	TIP	MODEL	KODA	TIP
Akumulat orji in polnilniki	1806B	821134-4	L	BHP456	141856-3	P	DF488D	821844-3	P
Pribor za akumulat orsko orodje	2012NB	824002-0	P	BHR202	824861-2	P	DFR440	140392-6	P
Akumulat orske svetilke in pribor	4112HS	824697-9	P	BHR240	824771-3	P	DFR540	141352-1	P
Pribor za lasarske merilnike	4326	824572-9	P	BHR241	824771-3	P	DFR550	141352-1	P
Pribor za rušenje in vrтанje	4327	824572-9	P	BHR261	824874-3	P	DFR750	141352-1	P
Pribor za vrтанje	4329	824572-9	P	BHR261T	824874-3	P	DFS250	821645-9	P
Kronske žage	4340CT	824809-4	P	BJR181	141354-7	P	DFS251	821645-9	P
Pribor za vijčenje	4341CT	824809-4	P	BJR181	824760-8	P	DFS441	821645-9	P
Pribor za rezanje in brušenje	4341FCT	824809-4	P	BJV140	824775-5	P	DFS451	821645-9	P
Pribor za poliranje in brušenje	4350CT	824809-4	P	BJV180	824775-5	P	DFS452	821645-9	P
Pribor za rezanje in brušenje	4350FCT	824809-4	P	BO4555	824806-0	P	DGA450	141257-5	P
Pribor za rezanje in brušenje	4351CT	824809-4	P	BO4557	824806-0	P	DGA452	141257-5	P
Pribor za rezanje in brušenje	4351FCT	824809-4	P	BO4565	824806-0	P	DGA504	821636-0	P
Pribor za rezanje in brušenje	4604D	824556-7	P	BO5030	824562-2	P	DGA506	821636-0	P
Pribor za rezanje in brušenje	5603R	824964-2	P	BO5031	824562-2	P	DGA701	821717-0	P
Pribor za rezanje in brušenje	5604R	824555-9	P	BO6040	824591-5	P	DGA900	821717-0	P
Pribor za rezanje in brušenje	5703R	824964-2	P	BPB180	141496-7	P	DGA901	821717-0	P
Pribor za rezanje in brušenje	5705R	824964-2	P	BSS610	824757-7	P	DGP180	821840-1	P
Pribor za rezanje in brušenje	5903R	193196-5	P	BDT130F	141205-4	P	DHG180	PR0000404	P
Pribor za rezanje in brušenje	6270D	824581-8	P	BDT140	141205-4	P	DHG181	PR0000404	P
Pribor za rezanje in brušenje	6305	182114-8	K	BDT144	141205-4	P	DHP343	158777-2	P
Pribor za rezanje in brušenje	6842	824808-6	P	BTD441	140354-4	P	DHP446	141856-3	P
Pribor za rezanje in brušenje	6843	824808-6	P	BTP130	141205-4	P	DHP453	158777-2	P
Pribor za rezanje in brušenje	6904VH	824439-1	P	BTP140	141205-4	P	DHP456	141856-3	P
Pribor za rezanje in brušenje	6905H	824698-7	P	BTW152	141205-4	P	DHP458	821524-1	P
Pribor za rezanje in brušenje	6906	182604-1	K	BTW251	141205-4	P	DHP459	158597-4	P
Pribor za rezanje in brušenje	6940D	824686-4	P	BTW450	141644-8	P	DHP481	821524-1	P
Pribor za rezanje in brušenje	6953	824630-1	P	CG100D	821710-4	P	DHP482	141856-3	P
Pribor za rezanje in brušenje	8280D	824581-8	P	DA330D	821556-8	P	DHP483	141856-3	P
Pribor za rezanje in brušenje	8391D	824853-1	P	DA4000LR	824646-6	P	DHP484	158597-4	P
Pribor za rezanje in brušenje	9558HNG	824985-4	P	DBM130	P-45141	K	DHR202	141642-2	P
Pribor za rezanje in brušenje	9565	182875-0	K	DBM131	P-45141	K	DHR241	141643-0	P
Pribor za zbijanje in spenjalnike	AF505N	HY00000090	P	DCG180	821568-1	P	DHR242	141401-4	P
Pribor za zbijanje in spenjalnike	AN510H	824793-3	P	DCS55ORFJ	141485-2	P	DHR263	142551-8	P
Pribor za zbijanje in spenjalnike	AN610H	824490-1	P	DDA341	141358-9	P	DHR400	821746-3	P
Pribor za fene	AN621	824582-6	P	DDA350	141358-9	P	DHS630	824995-1	P
Pribor za sesanje	AN901	824545-2	P	DDA450	821856-6	P	DJN161	142004-7	P
Pribor za uporabo na prostem	AT638	A0905-0361	P	DDF083	141856-3	P	DJR183	821586-9	P
Pribor za nošenje orodja in za oprema	BDF441	824754-3	P	DDF343	158777-2	P	DJR186	821620-5	P
Pribor za nošenje orodja in za oprema	BDF442	824774-7	P	DDF446	141856-3	P	DJR187	821620-5	P
Pribor za nošenje orodja in za oprema	BDF444	824754-3	P	DDF453	158777-2	P	DJR360	821620-5	P
Pribor za nošenje orodja in za oprema	BDF451	824754-3	P	DDF456	141856-3	P	DJV140	141486-0	P
Pribor za nošenje orodja in za oprema	BDF452	824774-7	P	DDF458	821524-1	P	DK18062	821599-0	P
Pribor za nošenje orodja in za oprema	BDF454	824754-3	P	DDF459	158597-4	P	DKP180	824982-0	P
Pribor za nošenje orodja in za oprema	BDF456	141856-3	P	DDF481	821524-1	P	DP3003	824595-7	P
Pribor za nošenje orodja in za oprema	BFS451	141490-9	P	DDF482	141856-3	P	DP4001	824595-7	P
Pribor za nošenje orodja in za oprema	BFS451	821645-9	P	DDF483	141856-3	P	DP4003	824595-7	P
Pribor za nošenje orodja in za oprema	BFS451	824978-1	P	DDF484	158597-4	P	DPJ180	141533-7	P
Pribor za nošenje orodja in za oprema	BGA450	824767-4	P	DF012DSE	824781-0	P	DPP200	SC09009190	P
Pribor za nošenje orodja in za oprema	BGA452	824767-4	P	DF030D	824842-6	P	DSC191	SC09009190	P
Pribor za nošenje orodja in za oprema	BHP441	824754-3	P	DF031D	821661-1	P	DSC250	SC09009190	P
Pribor za nošenje orodja in za oprema	BHP442	824774-7	P	DF330D	824842-6	P	DSC251	SC09009190	P
Pribor za nošenje orodja in za oprema	BHP451	140354-4	P	DF331D	821661-1	P	DST110	141074-3	P
Pribor za nošenje orodja in za oprema	BHP451	824754-3	P	DF332D	821661-1	P	DST220	141074-3	P
Pribor za nošenje orodja in za oprema	BHP452	824774-7	P	DF347D	824981-2	P	DST221	141074-3	P
Pribor za nošenje orodja in za oprema	BHP454	824754-3	P	DF457D	824981-2	P	DTD129	824979-9	P

# Kovčki in torbe za orodje













MODEL	KODA	TIP	MODEL	KODA	TIP	MODEL	KODA	TIP
DTD146	824979-9	P	HP331D	821661-1	P	HS7101	141736-3	P
DTD148	824979-9	P	HP332D	821661-1	P	HS7601	821622-1	P
DTD152	141856-3	P	HP347D	824981-2	P	JN3200	181797-1	K
DTD153	824979-9	P	HP457D	824981-2	P	JR001G	821796-8	P
DTD154	824979-9	P	HP488D	821844-3	P	JR100D	824993-5	P
DTD155	141856-3	P	HR005G	821837-0	P	JR103D	821662-9	P
DTD170	824979-9	P	HR006G	821848-5	P	JR105D	821662-9	P
DTD171	821750-2	P	HR007G	821864-7	P	JR3050T	821621-3	P
DTLO60	141493-3	P	HR166D	183H61-4	P	JR3060T	821621-3	P
DTM50	141562-0	P	HR1830	824650-5	P	JR3061T	821718-8	P
DTP141	824979-9	P	HR1840	821706-5	P	JR3070CT	821621-3	P
DTS141	824979-9	P	HR2020	824650-5	P	JS3200	181797-1	K
DTW190	141856-3	P	HR2300	821775-6	P	JV0600	824998-5	P
DTW250	141205-4	P	HR2440	824650-5	P	JV100D	821508-9	P
DTW251	141205-4	P	HR2450	824650-5	P	JV101D	821691-2	P
DTW281	824979-9	P	HR2470	824799-1	P	KP0800	824892-1	P
DTW285	824979-9	P	HR2470T	824799-1	P	KP0810	824786-0	P
DUC122	141494-1	P	HR2600	821775-6	P	LCT204	823304-1	A
DVP180	ASOVP007MK	A	HR2610	140402-9	P	MT060	183517-9	P
DVR450	141481-0	P	HR2610T	140404-5	P	MT064	183693-9	P
DVR850	141481-0	P	HR2611	140403-7	P	MT065	183693-9	P
FS2700	824890-5	P	HR2611F	140401-1	P	NI923B	P-72366	P
GA4530	824985-4	P	HR2611FT	140403-7	P	PJ7000	821509-7	P
GA5030	823294-8	A	HR2630	821775-6	P	SGI250	824709-8	P
GA9020	824958-7	P	HR2630T	824916-3	P	SGI50	B50856	K
HG5012K	HG130442	P	HR2631F	821775-6	P	SGI80	B50856	K
HG551VK	HG130442	P	HR2631FT	821775-6	P	SGI81	B50856	K
HG651CK	HG130442	P	HR2641	824695-3	P	TD090D	824842-6	P
HK0500	824523-2	P	HR2650	821724-3	P	TD110D	821661-1	P
HK1810	150640-5	P	HR2650	821781-1	P	TD111D	821661-1	P
HK1820	824789-4	P	HR2651	821722-7	P	TDI26D	824981-2	P
HM001G	141D88-6	P	HR2651	821780-3	P	TDI27D	824981-2	P
HM002G	821848-5	P	HR2651T	821722-7	P	TM3000C	821596-6	P
HMO870C	824905-8	P	HR2651T	821780-3	P	TM30D	143644-4	P
HMO871C	824905-8	P	HR2652	821781-1	P	TW001G	821828-1	P
HMI101C	140562-7	P	HR2653	821780-3	P	TW0350	824702-2	P
HMI111C	140562-7	P	HR2653T	821780-3	P	TW1000	824737-3	P
HMI203C	824876-9	P	HR2800	824789-4	P	TW100D	824781-0	P
HMI213C	824908-2	P	HR2810	824789-4	P			
HMI214C	824882-4	P	HR2811F	824789-4	P			
HMI304	183567-4	K	HR2811FT	824789-4	P			
HMI304B	183598-3	K	HR3200C	824825-6	P			
HMI307C	824898-9	P	HR3210C	824825-6	P			
HMI307CB	824898-9	P	HR3210FCT	824825-6	P			
HMI501	821839-6	P	HR3540C	824825-6	P			
HMI502	821839-6	P	HR4001C	140760-3	P			
HMI512	821839-6	P	HR4002	824798-3	P			
HP1640	824923-6	P	HR4003C	196277-4	P			
HP1641	824923-6	P	HR4010C	196183-3	P			
HP2050	824650-5	P	HR4013C	196531-6	P			
HP2051	824650-5	P	HR4500C	824607-6	P			
HP2051F	824650-5	P	HR4501C	158275-6	P			
HP2070	824650-5	P	HR5202C	196552-8	P			
HP2071	824650-5	P	HS009G	821866-3	P			
HP2071F	824650-5	P	HS300D	824961-8	P			
HP330D	821525-9	P	HS301D	821663-7	P			

**P:** plastični kovček **K:** kovinski kovček  
**T:** torba za orodje **L:** lesen kovček

- Akumulat orji in polnilniki
- Pribor za akumulat orske svetilke in pribor
- Akumulat orske svetilke in pribor
- Pribor za laserske merilnike
- Pribor za rušenje in vrtanje
- Pribor za rušenje in vrtanje
- Kronske žage
- Pribor za vijčenje
- Pribor za rezanje in brušenje
- Pribor za poliranje in brušenje
- Pribor za rezkanje in oblanje
- Pribor za multifunkcijsko orodje
- Pribor za žaganje
- Pribor za žebjalnike in spenjalnike
- Pribor za fene
- Pribor za sesanje
- Pribor za uporabo na prostem
- Pribor za nosenje orodja in zaščitna oprema
- Kovčki in torbe za orodje
- Ročno orodje
- Razno
- Pribor za mešanje

## Kovčki in torbe za orodje

## Ostale torbe za orodje

	Koda	Naziv	Za model	Mere (D x Š x V) (mm)	Gena z DDV
	168467-9	Tok	DF030D, DF330D	150 x 120 x 40	
	195638-5	Torba za orodje	DSL800, DSL801, DUX60, UX01G, DUX18	1.200 x 300 x 350	
	198589-1	Transportna torba	CP100D	330 x 190 x 130	
	199297-7	Torbica za akumulatorja	2 x BL18XX	170 x 70 x 110	
	199901-8	Torba za orodje	DCL281, CL001G	630 x 230 x 190	
	831253-8	Torba za orodje	/	350 x 200 x 250	
	831271-6	Torba za orodje	/	560 x 280 x 300	
	831276-6	Transportna torba	TD020D, TD021D	305 x 240 x 95	
	831279-0	Transportna torba LXT s kolesčki	/	700 x 380 x 300	
	831303-9	Transportna torba	DPB181	720 x 320 x 330	
	831327-5	Torba za orodje	RT0700C, RT0702C	410 x 350 x 105	
	832074-1	Torba za orodje	/	350 x 250 x 300	
	832188-6	Torba za sesalnik	CL121D	490 x 230 x 230	

Nadaljevanje...

Akumulat  
orji in  
poinliniki

Pribor za  
akumulat  
orsko  
orodje

Akumulat  
orske  
svetilke  
in pribor

Pribor za  
lasarske  
merilnike

Pribor za  
rušenje  
in vrtanje

Pribor za  
vrtanje

Kronske  
žage

Pribor za  
vijačenje

Pribor za  
rezanje  
in  
brušenje

Pribor za  
poliranje  
in  
brušenje

Pribor za  
rezkanje  
in  
oblanje

Pribor za  
multifunk  
cijsko  
orodje

Pribor za  
žaganje

Pribor za  
žebjalnike  
in  
spenjalnike

Pribor za  
fene

Pribor za  
sesanje

Pribor  
orodja za  
uporabo  
na prostem

Pribor za  
nosilje  
orodja in  
zaščitna  
oprema



Kovčki in  
torbe za  
orodje

Ročno  
orodje

Razno

Pribor za  
mešanje

# Kovčki in torbe za orodje

Koda	Naziv	Za model	Mere (D x Š x V) (mm)	Cena z DDV	
832319-7	Torba za orodje	/	350 x 220 x 200		
832366-8	Torba za orodje	/	700 x 310 x 320		

- Akumulat orji in polnilniki
- Pribor za akumulat orsko orodje
- Akumulat orske svetilke in pribor
- Pribor za lasarske merilnike
- Pribor za rušenje in vrtanje
- Pribor za vrtanje
- Kronske žage
- Pribor za vijčenje
- Pribor za rezanje in brušenje
- Pribor za poliranje in brušenje
- Pribor za rezkanje in oblanje
- Pribor za multitfunkcijsko orodje
- Pribor za žaganje
- Pribor za žebjalnike in spenjalnike
- Pribor za fene
- Pribor za sesanje
- Pribor orodja za uporabo na prostem
- Pribor za čiščenje orodja in zaščitna oprema
- Kovčki in torbe za orodje**
- Ročno orodje
- Razno
- Pribor za mešanje

# ROČNO ORODJE





## Univerzalne klešče



### Univerzalne klešče

Koda	Naziv	Dolžina (mm)	Premer (Ø) (mm)	Cena z DDV
B-65486	Univerzalne klešče	250	51	
B-65492	Univerzalne klešče	300	76	

### Papiga klešče



Koda	Naziv	Dolžina (mm)	Premer (Ø) (mm)	Cena z DDV
B-65741	Klešče univerzalne	180	37	
B-65757	Klešče univerzalne	240	49	
B-65763	Klešče univerzalne	300	68	

## Univerzalni ključ



### Nastavljivi ključ

Koda	Naziv	Dolžina (mm)	Premer (Ø) (mm)	Cena z DDV
B-65414	Nastavljiv ključ	150	29	
B-65420	Nastavljiv ključ	200	36	
B-65436	Nastavljiv ključ	250	38	
B-65442	Nastavljiv ključ	300	43	

### Blokirni univerzalni ključ

Za privijanje ali odvijanje vijakov in matic ali držanje pločevine. Možnost držanja obdelovanca kot s kleščami ali primežem.



Koda	Naziv	Dolžina (mm)	Premer (Ø) (mm)	Cena z DDV
B-65470	Blokirni univerzalni ključ	250	35	

Akumulat orji in pomliniki  
 Pribor za akumulat orsko orodje  
 Akumulat orske svetilke in pribor  
 Pribor za lasarske merilnike  
 Pribor za rušenje in vrtanje  
 Pribor za vrtanje  
 Kronske žage  
 Pribor za vijačenje  
 Pribor za rezanje in brušenje  
 Pribor za poliranje in brušenje  
 Pribor za rezkanje in oblanje  
 Pribor za multitfunkcijsko orodje  
 Pribor za žaganje  
 Pribor za žebjalnike in spenjalnike  
 Pribor za fene  
 Pribor za sesanje  
 Pribor orodja za uporabo na prostem  
 Pribor za hroščje orodja in zaščitna oprema  
 Kovčki in torbe za orodje  
 Ročno orodje  
 Razno  
 Pribor za mešanje



## Viličasto obročni ključ

Koda	Naziv	Dimenzija ključa (mm)	Cena z DDV
E-11586	Viličasto obročni ključ 8mm	8	
E-11592	Viličasto obročni ključ 10mm	10	
E-11601	Viličasto obročni ključ 12mm	12	
E-11617	Viličasto obročni ključ 13mm	13	
E-11623	Viličasto obročni ključ 14mm	14	
E-11639	Viličasto obročni ključ 15mm	15	
E-11645	Viličasto obročni ključ 16mm	16	
E-11651	Viličasto obročni ključ 17mm	17	
E-11667	Viličasto obročni ključ 18mm	18	
E-11673	Viličasto obročni ključ 19mm	19	

## Seti



	Koda	Naziv	Dimenzija ključa (mm)	Cena z DDV
	B-65458	11 delni set nastavljivih ključev	10, 11, 12, 13, 14, 15, 16, 17, 18, 19	
	B-65523	8 delni set dvojnih ključev z ragljo	8, 10, 12, 13, 14, 15, 17, 19	
	B-65539	9 delni set viličasto obročnih ključev	8, 10, 12, 13, 14, 15, 16, 17, 18	
	B-65545	5 delni set odprtih obročnih ključev	9×11, 10×12, 13×14, 15×17, 16×18	
	B-65551	5 delni set dvojnih obročnih ključev	8×9, 10×11, 12×13, 14×15, 18×19	

Akumulator  
orj in  
poinlinikiPribor za  
akumulator  
orsko  
orodjeAkumulator  
orske  
svetilke  
in priborPribor za  
laserske  
merilnikePribor za  
rušenje  
in vrtanjePribor za  
vrtanjeKronske  
žagePribor za  
vijačenjePribor za  
rezanje  
in  
brušenjePribor za  
poliranje  
in  
brušenjePribor za  
rezkanje  
in  
oblanjePribor za  
multifunk  
cijsko  
orodjePribor za  
žaganjePribor za  
žebjalnike  
in  
spenjalnikePribor za  
fenePribor za  
sesanjePribor  
orodja za  
uporabo  
na prostemPribor za  
nosilje  
orodja in  
zaščita  
opremaKovčki in  
torbe za  
orodjeRočno  
orodje

Razno

Pribor za  
mešanje

# Ročno orodje

349

## Raglje



Koda	Naziv	Vpetje	Cena z DDV
E-11558	Raglja 1/4" SQ, 84Z	1/4"	
E-11564	Raglja 3/8" SQ, 84Z	3/8"	
E-11570	Raglja 1/2" SQ, 84Z	1/2"	

## Imbus ključ



## Imbus ključ

Koda	Naziv	Velikost	Cena z DDV
B-65894	Imbus ključ 9 delni set	1,5, 2, 2,5, 3, 4, 5, 6, 8, 10	

## Kladiva

## Kladiva

Običajno kladivo za zabijanje in odstranjevanje žebeljev. Enodelna kovana zasnova za večjo trdnost in vzdržljivost.



Koda	Naziv	Dolžina (mm)	Teža (kg)	Cena z DDV
B-65779	Kladivo razcepjeno	250	0,57	

Akumulat  
orji in  
pomilniki

Pribor za  
akumulat  
orsko  
orodje

Akumulat  
orske  
svetilke  
in pribor

Pribor za  
laserske  
merilnike

Pribor za  
rušenje  
in vrtanje

Pribor za  
vrtanje

Kronske  
žage

Pribor za  
vijačenje

Pribor za  
rezanje  
in  
brušenje

Pribor za  
poliranje  
in  
brušenje

Pribor za  
rezkanje  
in  
oblanje

Pribor za  
multitank  
ciljsko  
orodje

Pribor za  
žaganje

Pribor za  
žebjalnike  
in  
spenjalnike

Pribor za  
fene

Pribor za  
sesanje

Pribor  
orodja za  
uporabo  
na prostem

Pribor za  
pogoje  
orodja in  
zaščitna  
oprema

Kovčki in  
torbe za  
orodje

Ročno  
orodje

Razno

Pribor za  
mešanje

## Set natičnih nastavkov z ragljo



## Set natičnih nastavkov z ragljo

Raglja s 84 zobmi. 4,3° nihaj raglje.

	Koda	Naziv	Natični ključiči (mm) ( )	Pribor ( )	Cena z DDV
	B-65567	34 delni set raglje in nasadnih ključičev	1/4" SQ: 4, 4.5, 5, 5.5, 6, 7, 8, 9, 10, 11, 12, 13 1/4" SQ globok nastavek: 5, 6, 7, 8, 9, 10, 11, 12, 13 T nastavek (25mm): T8, T10, T15, T20, T25, T27, T30, T40	84T raglja, 1/4" adapter, T ključ, podaljšek: 75 mm, 150 mm	
	B-65573	23 delni set raglje in nasadnih ključičev	3/8" SQ: 8, 9, 10, 11, 12, 13, 14, 15, 16, 17, 18, 19, 20 3/8" SQ sredinski nastavek: 8, 10, 13, 16, 17, 19	84T raglja, adapter 1/2", podaljšek: 75 mm, 150 mm	
	B-65589	23 delni set raglje in nasadnih ključičev	1/2" SQ: 10, 11, 12, 13, 14, 15, 16, 17, 18, 19, 20, 21, 22, 23, 24, 27, 30, 32	84T raglja, adapter 3/8", univerzalni spoj, podaljšek: 125 mm, 250 mm	

## Natični ključiči



## Natični ključiči

Koda	Dimenzija ključiča	Celotna dolžina (mm)	Cena z DDV
B-65648	10	32	
B-65654	11	32	
B-65660	12	32	
B-65676	13	32	
B-65682	14	32	
B-65698	15	32	
B-65707	16	32	
B-65713	17	32	
B-65729	18	32	
B-65735	19	32	

## Pribor

Ozka zasnova za lažje delo v tesnih prostorih. Gibljiva glava za bolj udobno delo.



Koda	Naziv	Dolžina (mm)	Cena z DDV
B-65844	Adapter 1/4	27	
B-65850	Adapter 3/8	32	
B-65632	Podaljšek za vtične ključe	75	
B-65610	Ravna raglja za natične ključe	205	
B-65626	Raglja za natične ključe s pregibno glavo	305	



## Seti

Raglja z 72 zobmi. 5° nihaj raglje. Za delo v tesnih prostorih.



Koda	Naziv	Natični ključji (mm) ( )	Pribor ( )	Cena z DDV
B-65595	14 delni set natičnih ključev	10, 11, 12, 13, 14, 15, 16, 17, 18, 19	Adapter 1/4", 3/8", podaljšek natičnega ključja - 75 mm z ragljo	
B-65604	21 delni set natičnih ključev	10, 11, 12, 13, 14, 15, 16, 17, 18, 19 Colski nastavek: 3/8", 7/16", 1/2", 9/16", 5/8", 11/16", 3/4"	Adapter 1/4", 3/8", podaljšek natičnega ključja - 75 mm, ročaj z ragljo	



Akumulat orji in polnilniki

Pribor za akumulat orsko orodje

Akumulat orske svetilke in pribor

Pribor za lasarske merilnike

Pribor za rušenje in vrtanje

Pribor za vrtanje

Kronske žage

Pribor za vijačenje

Pribor za rezanje in brušenje

Pribor za poliranje in brušenje

Pribor za rezkanje in oblanje

Pribor za multitank orodje

Pribor za žaganje

Pribor za žebjalnike in spenjalnike

Pribor za fene

Pribor za sesanje

Pribor orodja za uporabo na prostem

Pribor za ploščice in ograde in zaščitna oprema

Kovčki in torbe za orodje

Ročno orodje

Razno

Pribor za mešanje



## Izvijači

## Ploščati



Koda	Naziv	Dolžina (mm)	Tip vijaka	Tip	Cena z DDV
B-66020	Izvijač	100	SL4	magnetni	
B-66036	Izvijač	100	SL5.5	magnetni	
E-04933	Izvijač s kovinsko kapico SL5.5X75	75	SL5.5	magnetni	
B-66042	Izvijač	125	SL6.5	magnetni	
E-04949	Izvijač s kovinsko kapico SL6.5X150	150	SL6.5	magnetni	
B-66058	Izvijač	150	SL8,0	magnetni	
E-04955	Izvijač s kovinsko kapico SL8.0X200	200	SL8,0	magnetni	

## Torx



Koda	Naziv	Dolžina (mm)	Tip vijaka	Tip	Cena z DDV
B-65975	Izvijač	100	T10	magnetni	
B-65981	Izvijač	100	T15	magnetni	
B-65997	Izvijač	100	T20	magnetni	
B-66008	Izvijač	100	T25	magnetni	
B-66014	Izvijač	100	T30	magnetni	

## Križni



Koda	Naziv	Celotna dolžina (mm)	Tip vijaka	Tip	Cena z DDV
B-65903	Izvijač	100	PH1	magnetni	
B-66064	Izvijač s kovinsko kapico	75	PH1	magnetni	
B-65919	Izvijač	100	PH2	magnetni	
B-66070	Izvijač s kovinsko kapico	100	PH2	magnetni	
B-65931	Izvijač	150	PH3	magnetni	
B-66086	Izvijač s kovinsko kapico	150	PH3	magnetni	
B-65947	Izvijač	80	PZ1	magnetni	
B-66092	Izvijač s kovinsko kapico	75	PZ1	magnetni	
B-65953	Izvijač	100	PZ2	magnetni	
B-66101	Izvijač s kovinsko kapico	100	PZ2	magnetni	
B-65969	Izvijač	150	PZ3	magnetni	
B-66117	Izvijač s kovinsko kapico	150	PZ3	magnetni	



## Seti

Koda	Naziv	Celotna dolžina (mm)	Tip vijaka	Tip	Cena z DDV
E-10528	Set izvijačev 6 delni	100, PZ1 - 80	SL4, SL5.5, PH1, PH2, PZ1, PZ2	magnetni	
E-10534	Set izvijačev 5 delni	100	T10, T15, T20, T25, T30	magnetni	



Akumulat  
orji in  
povlečki

Pribor za  
akumulat  
orsko  
orodje

Akumulat  
orske  
svetilke  
in pribor

Pribor za  
laserske  
merilnike

Pribor za  
rušenje  
in vrtanje

Pribor za  
vrtanje

Kronске  
žage

Pribor za  
vijačenje

Pribor za  
rezanje  
in  
brušenje

Pribor za  
poliranje  
in  
brušenje

Pribor za  
rezkanje  
in  
oblanje

Pribor za  
multifunk  
cijsko  
orodje

Pribor za  
žaganje

Pribor za  
žebjalnike  
in  
spenjalnike

Pribor za  
fene

Pribor za  
sesanje

Pribor  
orodja za  
uporabo  
na prostem

Pribor za  
ročno je  
orodje in  
zaščitna  
oprema

Kovčki in  
torbe za  
orodje

Ročno  
orodje

Razno

Pribor za  
mešanje

## UDARNI IZVIJAČI



Odlični za odstranjevanje poškodovanih/posnetih vijakov, katerih ni bilo možno odvit z orodjem.

Z apliciranjem sile na ročaj se kreira navor za rotacijo izvijača v smeri odvijanja.



12°



Model	Celotna dolžina	Tip vijaka
B-42438	125 mm	PH2
B-42444	150 mm	PH3
B-42450	125 mm	PZ2
B-42466	150 mm	PZ3

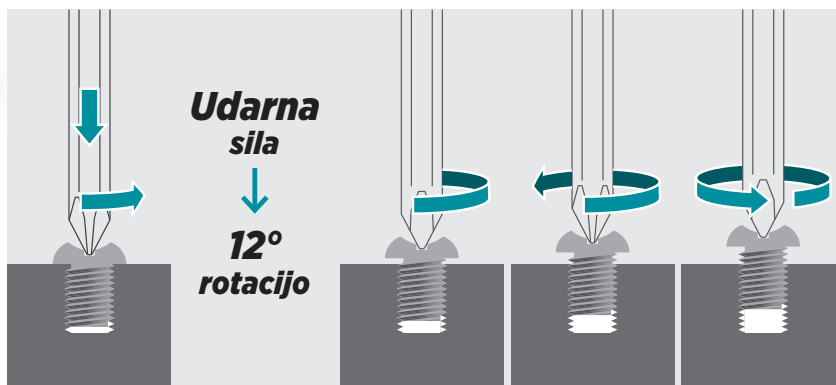

## TRAČNI METRI



### Varnost na prvem mestu!

Model B-57174 ima nameščeno držalo za pas z varnostno vrstico za varno delo na višini.



Model	Dolžina metra	Širina metra
E-03078	2 m	13 mm
B-57130	3,5 m	16 mm
B-57152	7,5 m	25 mm
B-57168	10 m	25 mm
B-57174	7,5 m	25 mm



### Vzdržljiv kavelj



gumiran odbijač zaščiti kavelj pri vračanju traku v ohišje



gumiran odbijač ščiti kavelj v primeru padca



kavelj s 4 rinkami + zaščito za večjo robustnost

### Posebni premazi



za 5x večjo odpornost merilnega traku









omogoča pisanje s svinčnikom po merilnem traku

## Noži



### Noži

Koda	Naziv	Enota (kos/set)	Cena z DDV	
B-65501	Zložljiv tapetniški nož	1		
B-65517	Rezila za zložljiv tapetniški nož	10/1		
B-65785	Tapetniški nož	1		
D-58855	Tapetniški nož	1		
D-72914	Strgalo za fuge z rezili	1		
D-74734	Rezila za tapetniški nož	10/1		
E-11520-12	Zložljivi nož z zamenljivim rezilom pk/12kos	12/1		

Akumulat  
orjji in  
poinliniki

Pribor za  
akumulat  
orsko  
orodje

Akumulat  
orske  
svetilke  
in pribor

Pribor za  
lasarske  
merilnike

Pribor za  
rušenje  
in vrtanje

Pribor za  
vrtanje

Kronske  
žage

Pribor za  
vijačenje

Pribor za  
rezanje  
in  
brušenje

Pribor za  
poliranje  
in  
brušenje

Pribor za  
rezkanje  
in  
oblanje

Pribor za  
multifunk  
ciljsko  
orodje

Pribor za  
žaganje

Pribor za  
žebjalnike  
in  
spenjalnike

Pribor za  
fene

Pribor za  
sesanje

Pribor  
orodja za  
uporabo  
na prostem

Pribor za  
nogo je  
orodja in  
zaščitna  
oprema

Kovčki in  
torbe za  
orodje

Ročno  
orodje

Razno



Pribor za  
mešanje

## Škarje za pločevino

## Škarje za pločevino

Primerne za pocinkano jekleno pločevino in U profile. Nedrseč ročaj. Jeklena zlitina iz kroma in molibdena za boljšo vzdržljivost.







	Koda	Naziv	Primerno za	Zmogljivost rezanja (valjano/nerjavno jeklo) ( )	Cena z DDV
	B-65791	Škarje za pločevino, ravne	Za ravno rezanje	18 ga (1,22 mm) / 23 ga (0,61 mm)	
	B-65800	Škarje za pločevino, leve	Za ravno rezanje in rezanje v levo	18 ga (1,22 mm) / 23 ga (0,61 mm)	
	B-65816	Škarje za pločevino, desne	Za ravno rezanje in rezanje v desno	18 ga (1,22 mm) / 23 ga (0,61 mm)	
	B-65822	Škarje za pločevino	Za rezanje debelih obdelovancev	16 ga (1,63 mm) / 18 ga (1,22 mm)	

## Orodje za izdelavo navojev

## Pribor



	Koda	Naziv	Cena z DDV
	B-65838	40 delni set za vrezovanje navojev	
	B-65866	Držalo za navojna rezila	
	B-65872	Adapter za pipo	
	B-65888	Adapter držala za navojna rezila	



# RAZNO

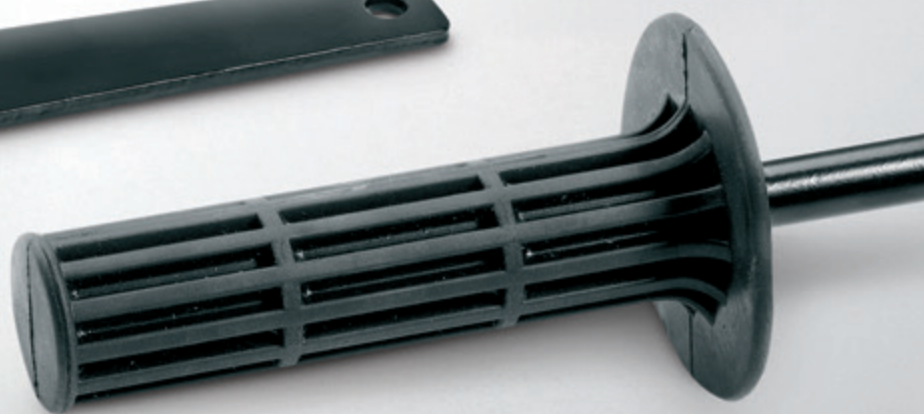

## Ročaji

## Stranski in krožni ročaji

	Koda	Naziv	Za model	Cena z DDV
	122575-0	Stranski ročaj	BDF460, BHP460	
	122711-8	Stranski ročaj	8414D, 8434D, 8444D	
	122712-6	Stranski ročaj	BHR200, 6319D, 6339D, 6349D	
	122727-3	Stranski ročaj	TW1000	
	122750-8	Stranski ročaj	BHP451, DHP451, DHP441	
	122C01-7	Stranski ročaj	DHP486, HP001G	
	123138-5	Stranski ročaj	DHR400, HR005G, HR4003C, HR4013C	
	123167-8	Stranski ročaj	BDF451	
	123257-7	Ročaj	HP458D	
	125779-3	Dodatni ročaj	BO5041	
	126413-8	Ročaj	DHP481	
	127551-9	Stranski ročaj	HP001G	
	134881-1	Stranski ročaj	HR5001C	
	134887-9	Stranski D ročaj	HR5000, HR5000K	

[Nadaljevanje...](#)

# Razno

359

Koda	Naziv	Za model	Cena z DDV	
134889-5	Stranski ročaj	HR3000C		
134890-0	Stranski D ročaj	HM1111C, HM1101C, HR3540C, HR3541FC, HR4001C, HR4002 HR4010C, HR4011C, HR4040C, HR4501C, HR4510C. HR4511C		
134903-7	Stranski ročaj	DP3003		
134909-5	Stranski D ročaj	HM1100, HM1100C, HM1200, HM1200B, HM1130, HM1130C, HM1140C, HM1211B HM0870C, HM0871C		
134910-0	Stranski ročaj	DP4003		
134915-0	Stranski D ročaj	HR4500C		
134945-1	Stranski D ročaj	HR5001C		
135197-7	Stranski ročaj	HR3200C, HR3210C, HR3210CCT		
135209-6	Stranski ročaj	HR3540C, HR3541FC, HR4001C, HR4010C, HR4011C HR4501C, HR4510C, HR4511C		
135269-8	Stranski D ročaj	HM1202C, HM1242C, HR5201C, HR5210C, HR5211C		
135283-4	Stranski D ročaj	HM1214C, HR5212C, HR006G		
135302-6	Stranski ročaj	HR2021, HR2022, HR2432, HR2441, HR2445, HR2451, HR2452, HR2453, HR2454, HR2455		
135332-7	Stranski ročaj	HM0870C, HM0871C, HM001G		
135380-6	Stranski ročaj	HR5201C, HR5210C, HR5211C		

[Nadaljevanje...](#)

Akumulat orji in polnilniki

Pribor za akumulat orsko orodje

Akumulat orske svetilke in pribor

Pribor za lasarske merilnike

Pribor za rušenje in vrtanje

Pribor za vrtanje

Kronske žage

Pribor za vijačenje

Pribor za rezanje in brušenje

Pribor za poliranje in brušenje

Pribor za rezkanje in oblanje

Pribor za multitfunkcijsko orodje

Pribor za žaganje

Pribor za žebjalnike in spenjalnike

Pribor za fene

Pribor za sesanje

Pribor orodja za uporabo na prostem

Pribor za čiščenje orodja in zaščita oprema

Kovčki in torbe za orodje

Ročno orodje

Razno

Pribor za mešanje

	Koda	Naziv	Za model	Cena z DDV
Akumulat orji in polnilniki				
Pribor za akumulat orsko orodje	 135629-4	Stranski ročaj	HR006G, HR5202C, HR5212C	
Akumulat orske svetilke in pribor	 140G50-6	Stranski ročaj	DUT130	
Pribor za laserske merilnike	 140X75-2	Stranski ročaj	DPV300, PV301D	
Pribor za rušenje in vrtanje	 140Y64-3	Stranski ročaj	RS002G	
Pribor za vrtanje	 151776-3	Stranski ročaj	9077SL	
Kronske žage	 151949-8	Stranski ročaj	6300-4	
Pribor za vijčenje	 151965-0	Stranski ročaj	6300-4, 6013BR, 6300NB, 6016, DP4700	
Pribor za rezanje in brušenje	 152492-0	Stranski ročaj	6300-4, 6013BR, 6300NB, 6016, DP4700	
Pribor za poliranje in brušenje	 152539-0	Stranski ročaj	PK5011C	
Pribor za rezkanje in oblanje	 152612-6	Stranski ročaj	5901B	
Pribor za multitank orodje	 153489-2	Stranski ročaj	MT952, MT953, 9554NB, PW5000CH, GA5080R, DGA520, DGA521, RT0702C	
Pribor za žaganje	 154935-8	Stranski ročaj	BDF444RFE, BDF454RFE	
Pribor za žebjalnike in spenjalnike	 158057-6	Stranski ročaj	BHR202, BHR242, BHR243, BHR261, BHR262, HP1230, HR1830, HR1830F, HR1830FT, HR2230, HR2460, HR2460F, HR2470, HR2470F, HR2470T, HR2470FT, HR2475, HR2800, HR2810, HR2810FT, HR2811FT	
Pribor za fene	 158131-0	Stranski ročaj	HM0830, HM0870C, HM0871C, HR3000C, HR3530, HR3540C, HR3541FC, HR4000C, HR4001C, HR4002, HR4010C, HR4011C, HR4030C, HR4041C, HR4500C, HR4501C, HR4510C, HR4511C, HR5001C, HR5201C, HR5210C, HR5211C	
Pribor za sesanje	 158237-4	Stranski ročaj	DGA504, DDA450, GA5051R	
Pribor orodja za uporabo na prostem	 158237-4	Stranski ročaj	DGA504, DDA450, GA5051R	
Pribor za nosenje orodja in zaščita oprema	 158237-4	Stranski ročaj	DGA504, DDA450, GA5051R	
Kovčki in torbe za orodje				
Ročno orodje				
Razno				
Pribor za mešanje				

Nadaljevanje...

# Razno

361

Koda	Naziv	Za model	Cena z DDV
162264-5	Stranski ročaj z dušenjem vibracij	GA9040S	
163506-0	Stranski ročaj	HM1317CB	
191D07-2	Stranski ročaj	DHR171, DHR182, HR140D, HR166D, HR1840	
191E41-8	Stranski ročaj	DDF484, DF002G, DHP484, HP002G	
192258-6	Krožni ročaj	9069, 9059	
194514-0	Stranski ročaj z dušenjem vibracij	GA5010, CA5011, GA5020, GA5021, GA5021C, GA6010, CA6011, GA6020, GA6020C, GA6021, GA6021C, GA5050R, GA4550R, DGA520, DGA521	
194684-5	Set za pritrditev ročaja	GA7020, GA7020S, GA7030, GA7030S, GA7040S, GA9020, GA9020S, GA9030, GA9030S, GA9041S	
196792-8	Stranski D ročaj	DHR400, HR4003C, HR4013C, HR005G	
199176-9	Krožni ročaj	GA7062, GA9060, GA9062	
273404-1	Stranski ročaj	6013BR-T17273404-1	
273423-7	Stranski ročaj	HM1400	
273495-2	Stranski ročaj	LS1030, LS800DWA	
416256-9	Krožni ročaj	9227C, PC5000C	
416348-4	Krožni ročaj	9227CB	



[Nadaljevanje...](#)

Akumulat  
orji in  
povlekinke

Pribor za  
akumulat  
orsko  
orodje

Akumulat  
orske  
svetilke  
in pribor

Pribor za  
lasarske  
merilnike

Pribor za  
rušenje  
in vrtanje

Pribor za  
vrtanje

Kronske  
žage

Pribor za  
vijačenje

Pribor za  
rezanje  
in  
brušenje

Pribor za  
poliranje  
in  
brušenje

Pribor za  
rezkanje  
in  
oblanje

Pribor za  
multifunk  
ciljsko  
orodje

Pribor za  
žaganje

Pribor za  
žebjalnike  
in  
spenjalnike

Pribor za  
fene

Pribor za  
sesanje

Pribor  
orodja za  
uporabo  
na prostem

Pribor za  
ročajne  
orodja in  
zaščitna  
oprema



Kovčki in  
torbe za  
orodje

Ročno  
orodje

Razno

Pribor za  
mešanje



	Koda	Naziv	Za model	Cena z DDV
	419792-4	Stranski ročaj	HR5210C, HR5211C	
	6254502100	Ročaj	RBC261	
	XNR0000304	Krožni ročaj	EBH341	





## Ključ

### Montažni zatični ključ



Koda	Naziv	Velikost	Za model	Cena z DDV
782401-1	Montažni ključ	20 mm	PJ7000, 3901, BPJ180, DPJ180	
782412-6	Montažni ključ	28 mm	9207, 9217, GV7000	
197610-3	Montažni zatični ključ 35 GA7010C	35 mm	GA9010, GA9020, GA9030, GA9040, GA7010, GA7020, GA7030, GA7040, GA5040, GA4540	
782423-1	Montažni ključ	35 mm	GA6021, GA6021C, 9558, 9557	
782426-5	Montažni ključ	35 mm	PC5000, PC5001	

### Nasadni ključ

	Koda	Naziv	Velikost	Za model	Cena z DDV
	782203-5	Nasadni ključ z nastavkom	SW9	2012NB	
	782209-3	Nasadni ključ z nastavkom	SW9	1902, 1911B, 1923H, 4101R, 4105KB, BKP180, KP0800, KP0810, KP0810C	
	782210-8	Nasadni ključ z nastavkom	SW17	2414NB, 4112HS, AT3624, BBC231U, BC231UD, LC1230	
	782212-4	Nasadni ključ	SW13	LH1040, LH1040F, LS1040, LS1040F, LS1013, LS1013F, LS1013L, LS1214, LS1214F, LS1214L, LS1440	
	JM27000087	Nasadni ključ	SW25	MLT100X	

# PRIBOR ZA MEŠANJE



## Mešala

Z zaščitnim obročem, ki preprečuje poškodbe posode med mešanjem.  
Mešala za mešanje tekočin, hitro sušečih tekočin in viskoznih materialov.



Koda	Vpenjalo orodja	Material	Premer	Dolžina	Mešanje	Kapaciteta mešanja	Maksimalno št. vrtljajev
D-73508	M14	Tekočine	120 mm	600 mm	▼	15 kg	1.300 min <sup>-1</sup>
D-73514	M14	Viskozne snovi	120 mm	600 mm	▲	20 kg	590 min <sup>-1</sup>
D-73520	M14	Hitro sušeče tekočine	120 mm	600 mm	▼	18 kg	1.300 min <sup>-1</sup>
D-73536	3/8" hex	Tekočine	120 mm	600 mm	▼	15 kg	1.300 min <sup>-1</sup>
D-73542	3/8" hex	Viskozne snovi	120 mm	600 mm	▲	20 kg	500 min <sup>-1</sup>

Koda		D-73508	D-73536	D-73520	D-73514	D-73542
Tip mešala		Z 2 lopaticama za tekočine		S 3 lopaticami za hitro sušeče tekočine	Z 2 lopaticama za viskozne snovi	
Slika mešala						
Lastnosti	Mešanje	 Mešanje materiala od zgoraj navzdol.		 Mešanje materiala od zgoraj navzdol.	 Mešanje materiala od spodaj navzgor.	
	Material	Uporablja se za mešanje splošnih tekočin materialov. Ker se material meša od zgoraj navzdol, je razprševanje materiala manjše tudi pri visoki hitrosti.		Ker se material meša od zgoraj navzdol, je razprševanje materiala manjše tudi pri visoki hitrosti. Poleg tega imajo 3 lopatice visoko učinkovitost mešanja, kar močno skrajša čas mešanja. Zato so mešala primerna za mešanje tekočih materialov s kratkim časom strjevanja.	Ker se material meša od spodaj navzgor, to preprečuje nabiranje težjih usedlin na dnu posode. Malta je mešanica cementa, peska in vode, zato se zaradi gravitacije na dnu nabirajo usedline težkega peska. Zato lahko z mešanjem peska na vrhu takšne materiale učinkovito premešamo.	
Največja masa mešanega materiala		15 kg		18 kg	20 kg	
Najvišje število vrtljajev		1.300 min <sup>-1</sup>		1.300 min <sup>-1</sup>	590 min <sup>-1</sup>	500 min <sup>-1</sup>
Tekočine	Stenske barve	✓		✓	✗	
	Disperzije	✓		✓	✗	
	Premazi	✓✓		✗	✗	
	Laki	✓✓		✗	✗	
	Emulzije	✓✓		✗	✗	
	Epoksidne smole	✓✓		✗	✗	
	Mavčni ometi	✗		✓✓	✗	
Viskozne snovi	Lepila	✗		✗	✓✓	
	Cementne mase	✗		✗	✓✓	
	Malta	✗		✗	✓✓	
	Mavec	✗		✗	✓✓	

✓ Primerno   ✓✓ Zelo primerno   ✗ Ni priporočljivo

# Pribor za mešanje

## Mešalna rezila in pribor

Mešalna rezila iz nerjavečega jekla za barve. Oblika rezila zagotavlja hiter in uravnotežen rezultat mešanja. Rezila se primerna za mešanje tekočin, emulzijskih barv in lakov.



A-43670



A-43686



A-43692

Mešalno rezilo					Vijak	
Koda	Premer	Material	Kapaciteta mešanja	Maksimalno št. vrtljajev	Koda	Velikost
A-43670	130 mm	Barve na osnovi topil, barve za zid, laki, epoksi smola	5-15 kg	1.300 min <sup>-1</sup>	265220-5	M8 x 18
A-43686	150 mm	Barve za zid, laki, epoksi smola	15 kg	1.300 min <sup>-1</sup>	vijak in matica priložena	M8 x 25
A-43692	165 mm	Barve za zid, laki, epoksi smola	10-20 kg	1.300 min <sup>-1</sup>	265220-5	M8 x 18



Vreteno		
Koda	Navoj vretena	Dolžina
168349-5	M12	550 mm
168884-3	M14	

Adapter za vreteno		
Koda	Vpenjalo orodja	Vpenjalo vretena
323962-8	1/2" - 20 UNF	M12
P-22062	1/2" - 20 UNF	M14
324929-9	5/8" - 16 UNF	M14
P-02325	5/8" - 16 UNF	M14



- Akumulat orji in pomliniki
- Pribor za akumulat orsko orodje
- Akumulat orske svetilke in pribor
- Pribor za lasarske merilnike
- Pribor za rušenje in vrtanje
- Pribor za vrtanje
- Kronske žage
- Pribor za vijačenje
- Pribor za rezanje in brušenje
- Pribor za poliranje in brušenje
- Pribor za rezkanje in oblanje
- Pribor za multitfunkcijsko orodje
- Pribor za zaganje
- Pribor za žebjalnike in spenjalnike
- Pribor za fene
- Pribor za sesanje
- Pribor orodja za uporabo na prostem
- Pribor za nosenje in zaščitna oprema
- Kovčki in torbe za orodje
- Ročno orodje
- Razno
- Pribor za mešanje



Akumulat orji in povlečni	
Pribor za akumulat orsko orodje	
Akumulat orske svetilke in pribor	
Pribor za laserske merilnike	
Pribor za rušenje in vrtanje	
Pribor za vrtanje	
Kronske žage	
Pribor za vijačenje	
Pribor za rezanje in brušenje	
Pribor za poliranje in brušenje	
Pribor za rezkanje in oblanje	
Pribor za multifunk cijsko orodje	
Pribor za žaganje	
Pribor za žebjalnike in spenjalnike	
Pribor za fene	
Pribor za sesanje	
Pribor orodja za uporabo na prostem	
Pribor za nošenje orodja in zaprta oprema	
Kovčki in torbe za orodje	
Ročno orodje	
Razno	
Pribor za mešanje	





Akumulat orji in polnilniki	
Pribor za akumulat orsko orodje	
Akumulat orske svetilke in pribor	
Pribor za laserske merilnike	
Pribor za rušenje in vrtanje	
Pribor za vrtanje	
Kronske žage	
Pribor za vijačenje	
Pribor za rezanje in brušenje	
Pribor za poliranje in brušenje	
Pribor za rezkanje in oblanje	
Pribor za multifunk cijsko orodje	
Pribor za žaganje	
Pribor za žebjalnike in spenjalnike	
Pribor za fene	
Pribor za sesanje	
Pribor orodja za uporabo na prostem	
Pribor za nošenje orodja in zadrževalni sistema	
Kovčki in torbe za orodje	
Ročno orodje	
Razno	
Pribor za mešanje	



# Beležka

Akumulat orji in polnilniki	
Pribor za akumulat orsko orodje	
Akumulat orske svetilke in pribor	
Pribor za laserske merilnike	
Pribor za rušenje in vrtanje	
Pribor za vrtanje	
Kronske žage	
Pribor za vijačenje	
Pribor za rezanje in brušenje	
Pribor za poliranje in brušenje	
Pribor za rezkanje in oblanje	
Pribor za multifunk cijsko orodje	
Pribor za žaganje	
Pribor za žebjalnike in spenjalnike	
Pribor za fene	
Pribor za sesanje	
Pribor orodja za uporabo na prostem	
Pribor za nošenje orodja in zaprta oprema	
Kovčki in torbe za orodje	
Ročno orodje	
Razno	
Pribor za mešanje	



MAKITA d.o.o., Brnčičeva 17,  
1231 Ljubljana-Črnuče, Slovenija  
T: +386 (0) 59 083 600, E: info@makita.si

Skupina Makita si pridržuje pravico do sprememb v tem katalogu in pravico do obveščanja v vseh oblikah in načinih v zvezi s tem katalogom. Pridržujemo si pravico do morebitnih tiskarskih napak. Slike proizvodov v katalogu lahko odstopajo od dejanskega stanja proizvoda.



www.makita.si



Makita Eastern Europe



MakitaSLO



makita\_eastern\_europe